



2

Kindergarten

Skills 2 | Teacher Guide

Kindergarten

Skills 2

Teacher Guide

Notice and Disclaimer: The agency has developed these learning resources as a contingency option for school districts. These are optional resources intended to assist in the delivery of instructional materials in this time of public health crisis. Feedback will be gathered from educators and organizations across the state and will inform the continuous improvement of subsequent units and editions. School districts and charter schools retain the responsibility to educate their students and should consult with their legal counsel regarding compliance with applicable legal and constitutional requirements and prohibitions.

Given the timeline for development, errors are to be expected. If you find an error, please email us at texashomelearning@tea.texas.gov.

ISBN 978-1-68391-919-3

This work is licensed under a Creative Commons Attribution-NonCommercial-ShareAlike 4.0 International License.

You are free:

to Share—to copy, distribute, and transmit the work

to Remix—to adapt the work

Under the following conditions:

Attribution—You must attribute any adaptations of the work in the following manner:

This work is based on original works of Amplify Education, Inc. (amplify.com) and the Core Knowledge Foundation (coreknowledge.org) made available under a Creative Commons Attribution-NonCommercial-ShareAlike 4.0 International License. This does not in any way imply endorsement by those authors of this work.

Noncommercial—You may not use this work for commercial purposes.

Share Alike—If you alter, transform, or build upon this work, you may distribute the resulting work only under the same or similar license to this one.

With the understanding that:

For any reuse or distribution, you must make clear to others the license terms of this work. The best way to do this is with a link to this web page:

<https://creativecommons.org/licenses/by-nc-sa/4.0/>

© 2020 Amplify Education, Inc.
amplify.com

Trademarks and trade names are shown in this book strictly for illustrative and educational purposes and are the property of their respective owners. References herein should not be regarded as affecting the validity of said trademarks and trade names.

Printed in Mexico
01 XXX 2021

Contents

Introduction 1

Lesson 1 Prerequisite Skills: Blending and Prewriting 7

Prerequisite Foundational Skills (25 min.)

- Warm-Up: Syllable Blending
- Practice Blending: Tap and Chase
- Track from Left to Right and Top to Bottom

Prerequisite Writing Skills (35 min.)

- Fine Motor Skills: Make Cups with Modeling Clay
- Draw Cups on a Vertical Surface
- Cup Practice

Lesson 2 Prerequisite Skills: Blending and Prewriting 16

Prerequisite Foundational Skills (25 min.)

- Warm-Up: Syllable Blending
- Practice Blending:
 - Tap and Chase
 - Blend Syllables and Sounds

Prerequisite Writing Skills (35 min.)

- Fine Motor Skills: Make Humps with Modeling Clay
- Draw Humps on a Vertical Surface
- Hump Practice

Lesson 3 Prerequisite Skills: Blending and Prewriting 25

Prerequisite Foundational Skills (25 min.)

- Warm-Up: Syllable and Sound Blending
- Practice Blending:
 - Blending Gestures
 - Picture Card Blending

Prerequisite Writing Skills (35 min.)

- Draw Zigzags on a Vertical Surface
- Zigzag Practice
- Differentiate Shapes

Lesson 4 Prerequisite Skills: Blending and Prewriting 36

Prerequisite Foundational Skills (25 min.)

- Warm-Up: Sound Blending
- Practice Blending: Picture Card Blending
- Listening for Beginning Sounds: Mixed-Up Monster

Prerequisite Writing Skills (35 min.)

- Draw Wavy Lines on a Vertical Surface
- Wavy Line Practice
- Left-to-Right Directionality: Beginning/End Recognition

Lesson 5 Prerequisite Skills: Blending and Prewriting

46

Prerequisite Foundational Skills (25 min.)

- Warm-Up: Sound Blending
- Practice Blending: Picture Card Blending
- Listening for Beginning Sounds: If Your Name Starts With . . .

Prerequisite Writing Skills (35 min.)

- Draw Spirals on a Vertical Surface
- Spiral Practice
- Name Tracing

Lesson 6 Prerequisite Skills: Blending and Prewriting

55

Prerequisite Foundational Skills (25 min.)

- Warm-Up: Sound Blending
- Practice Blending: Picture Card Blending
- Listening for Beginning Sounds: Guess Who?

Prerequisite Writing Skills (35 min.)

- Drawing + and x on a Vertical Surface
- + and x Practice
- Name Tracing

Lesson 7 Prerequisite Skills: Blending and Prewriting

64

Prerequisite Foundational Skills (25 min.)

- Warm-Up: Sound Blending
- Practice Blending: Picture Card Blending
- Listening for Beginning Sounds: Find Things by Beginning Sound

Prerequisite Writing Skills (35 min.)

- Draw Loops on a Vertical Surface
- Loop Practice
- Name Tracing

Lesson 8 Prerequisite Skills: Blending and Prewriting

72

Prerequisite Foundational Skills (25 min.)

- Warm-Up: Sound Blending
- Practice Blending: Mystery Pictures
- Listening for Beginning Sounds: Find Things by Beginning Sound

Prerequisite Writing Skills (35 min.)

- Draw Canes on a Vertical Surface
- Cane Practice
- Name Tracing

Lesson 9 Prerequisite Skills: Blending and Prewriting

81

Prerequisite Foundational Skills (25 min.)

- Warm-Up: Sound Blending
- Practice Blending:
 - Mystery Pictures
 - Add a Sound

Prerequisite Writing Skills (35 min.)

- Draw Hooks on a Vertical Surface
- Hook Practice
- Name Tracing

Lesson 10 Unit Assessment: Student Performance Assessment

90

Prerequisite Foundational Skills (25 min.)

- Warm-Up: Sound Blending
- Practice Blending:
 - I Spy
 - Add a Sound

Prerequisite Writing Skills (35 min.)

- Name Tracing
- Student Performance Assessment
 - Part 1 (Writing Strokes)
 - Part 2 (Blending)

Pausing Point (3 days)

99

Teacher Resources

111

Introduction

Units 1 and 2 are in many ways the most important units of the Kindergarten Skills Strand. These units lay the foundation for students' future reading and writing. In Unit 1, students learned that speech is made up of words, and they practiced distinguishing and counting environmental sounds. In Unit 2, students will learn how to blend "chunks" of speech sounds. They will learn to blend segmented syllables to say two-syllable words, and how to blend individual sounds known as phonemes to say two- and three-sound words.

Blending is a critical skill for reading. In fact, it is the single most important skill for reading. Working with sounds, or phonemes, is also extremely important because our writing system is for transcribing sounds into print. If students can learn to hear individual sounds and blend those sounds to make words, they will be well prepared to use the letter-sound correspondences they will study in Unit 3 and beyond as the basis for decoding.

SKILLS 2 LESSON STRUCTURE

The lessons in Unit 2 are structured in much the same way as the lessons in Unit 1. They are divided between oral language exercises and prewriting exercises. However, in this unit, the emphasis in the oral language exercises is on blending. Therefore, all of the lessons in Unit 2 begin with Warm-Up exercises that teach blending skills and reinforce the process with blending motions. In Lessons 1 and 2, the Warm-Up consists of syllable blending coupled with hand motions and clapping. In Lesson 3, students first practice blending syllables and then sounds with the same clapping gestures. In Lessons 4–10, the emphasis is on blending sounds, and students practice blending three sounds using arm gestures introduced in Lesson 3. The blending in the Warm-Up exercises is purely oral, and there are no letters or pictures involved.

A set of Blending Picture Cards have been provided. The set consists of thirty-nine colored pictures of objects and items. The pictures can be used as visual cues to help students blend names of objects and items. These names consist of either two or three sounds and are therefore suitable for early blending practice.

In the prewriting exercises students will learn additional shapes and strokes that will be helpful to them when they begin writing letters in the next unit. The main skills for this unit are outlined in the following sections.

ORAL LANGUAGE EXERCISES

The main purpose of the oral language exercises in this unit are to develop students' oral blending skills and to introduce students to blending at the phoneme level. The ability to blend sounds is crucial to reading because reading consists of decoding sounds represented by letters and blending those sounds together to make words. As adult readers, our minds have been altered by the process of reading and we no longer read in a procedural way (or perhaps the procedures have become so automatic we are no longer aware of them). Children are different. They need to practice blending sounds into words without any connection to print. When students can hear three sounds and blend those sounds to make a word, they are ready to start learning the alphabetic code. You will begin teaching the code in Unit 3.

In the first three lessons of this unit, students will blend two syllables to form two-syllable words. This is analogous to blending sounds to form words, which will be the next step. Blending syllables, however, is much easier because syllables can be meaningful units (e.g., ant·hill) as opposed to sounds, which are abstract and have no meaning in isolation (e.g., /a/ . . . /n/ . . . /t/).

Once students are comfortable blending two syllables, they will then blend two sounds before moving on to blending three sounds. In many of the exercises, students will be offered visual cues to support their blending. Using the Blending Picture Cards will be extremely helpful because the cards will limit the set of possible answers to the images displayed. If you are not familiar with the sounds of English, or if you are unclear why it is important for students to develop phonemic awareness, you may wish to read Appendix A, "More on Sounds and Blending."

As a teacher, you should be aware of the difference between sequential and final blending. In sequential blending the word is built step by step by adding sounds to blended sound sequences. For example, the word *fish* is blended like this: "/f/" . . . "/i/" . . . "fi" . . . "/sh/" . . . "fish." In final blending, the sounds in a word are said individually and then blended: "/f/" . . . "/i/" . . . "/sh/" . . . "fish." Final blending is described in the blending exercises used in this program. If a student requires more support, use sequential blending with the student. (For more discussion of these differences, see the section titled "Two Ways to Teach Blending" in Appendix A.)

When blending, utilize motions to make the process a kinesthetic experience. In this unit, two sets of gestures for blending are taught. The first set of gestures, explained in Lesson 1, works when blending two syllables or two sounds. It involves opening a palm for each component and then clapping the hands together when the two components are blended. The second set of gestures, introduced in Lesson 3, works for blending three sounds. It involves pointing to three parts of the arm (shoulder, elbow, and wrist) and sweeping the hand along the arm while blending the sounds. The specifics of these techniques are explained in the Warm-Ups of each lesson. Please do not be constrained by the exact wording of the explanation. What is important is that students learn to experience phonemes as countable and concrete realities, so any set of patterned movements will work. If you are accustomed

to using finger motions to illustrate blending, substitute finger motions for the arm motions described in the lessons. One system of finger motions is described in Appendix A, in the section titled “Finger Gestures for Blending.” Being able to hear the individual sounds in a word and recognize their positions in the word is an important skill needed to spell words. Unit 2 contains a number of exercises which develop students’ ability to recognize the beginning sound in a word. The focus in this unit is predominantly on initial sounds because these are the easiest for children to hear and segment.

PREWRITING SKILLS

Unit 2 continues to reinforce the difference between left and right, while also focusing on tracking from left to right on paper. Another important skill that will be taught in the writing portion of this unit is how to identify the beginning, middle, and end of rows. This is helpful for both left-to-right tracking and identifying the position of sounds in a word. It is important for students to be familiar with these concepts, as they will prove useful when students begin to work with printed three-sound words in Unit 3.

In this unit, students still work with crayons and continue to practice forming the tripod grip. Work carefully to correct improper grips when you see them—the correct grip will help students write smoothly and efficiently later on. The tripod grip is emphasized continually throughout the unit as students draw various types of strokes and shapes, preparing them for writing letters. Students work with cups, humps, zigzags, wavy lines, spirals, +’s, x’s, loops, canes, and hooks in this unit by completing a number of activity pages. They will also continue to practice their fine motor skills by forming some of the strokes and shapes with modeling clay, or another soft modeling compound.

In Unit 2, students will also learn to recognize and trace their names. Students should be able to identify their names as a special shape with special meaning even before they begin writing lowercase letters. You should teach them to write their names beginning with a capital letter.

SKILLS 2 ASSESSMENT

Additional Pretests

In Unit 1 you were asked to give two pretests, the Writing Strokes Pretest and the Blending Pretest. These are the two most important pretests, and they should, ideally, be given to all students before beginning this unit. Two additional, optional pretests are included as appendices in this Teacher Guide. One is a test of letter-sound correspondences, and the other is a test of letter names. It is not essential to administer these pretests at this time because you will be teaching students the letter-sound correspondences in Unit 3 and beyond. Letter names will be taught later in the year. However, you may wish to administer these additional tests to establish a baseline against which to measure subsequent progress.

Although the teaching of letter names is postponed in this program, it may be useful to know which students already know them. Some students struggle to read words because they use the letter names instead of the sound values. By giving the Letter Name Pretest, you can determine which students know the letter names and may be susceptible to this source of confusion.

Formative Assessments and Additional Support

Throughout this unit, formative assessments are clearly marked for monitoring student performance and progress in key skills:

- blending syllables and individual sounds (phonemes)
- copying different writing strokes including vertical, horizontal and diagonal lines, circles, a cup, a hump, a zigzag, a wavy line, a spiral, a +, an x, a loop, a cane, and a hook

Quick “Checks for Understanding” are also designated in various lessons.

Paying careful attention to this information, collected on a daily basis, will enable teachers to quickly determine which students may benefit from reteaching and/or more practice in particular skills, using the Additional Support activities found at the end of each lesson.

Student Performance Assessment

In Lesson 10, you will be prompted to use activity pages during instructional time to assess students’ ability to copy previously taught writing strokes, as well as draw a cup, a hump, a zigzag, a wavy line, a spiral, a +, an x, a loop, a cane, and a hook.

You will also administer an oral blending assessment in Lesson 10 to all students in a whole class setting. Students will see pictures of various words on an activity page and will be directed to circle the picture of a word that you present in a segmented fashion, sound by sound. In order to respond correctly, students must mentally blend the sounds to form recognizable words. While not mandatory, you may want to re-administer the individual Blending Pretest from Unit 1, Lesson 4 to any students who perform poorly on the Unit 2 Blending Assessment.

Instructions for administering and scoring the assessment are included in Lesson 10.

PAUSING POINT

The ten lessons in this unit are followed by a Pausing Point with suggestions for further practice and reinforcement. As with Unit 1, it is strongly recommended that you pause for 2 or 3 days to solidify the skills that have been introduced in this unit before moving on to the next unit. If students are having trouble with any of the unit skills, especially with blending, it is particularly important that you make use of the targeted activities for additional practice.

APPENDICES

Unit 2 includes three appendices. Appendix A provides additional, detailed information on the sounds in the English language and blending. This information is very helpful in providing a deeper level of understanding to enable you to assist your students and scaffold instruction, but it is likely very unfamiliar to most elementary school teachers. If you have a speech and language specialist available as a resource at your school, you may find it helpful to talk to them if you have questions.

As previously mentioned, the other appendices are strictly optional pretests, which you may decide at your discretion whether or not to administer. Appendix B is a Letter-Sound Correspondence Pretest and Appendix C is a Letter Name Pretest.

TEACHER RESOURCES

At the back of this Teacher Guide, you will find a section titled Teacher Resources. In this section, you will find assorted forms and charts that may be useful, including:

- Oral Blending Observation Record—Unit 2
- Sample Oral Blending Observation Record
- Writing Strokes Assessment Scoring Guide
- Writing Strokes Assessment Class Summary Sheet
- Record Sheet for Unit 2 Student Performance Assessment
- Additional Support Activity Pages
- Activity Book Answer Key
- Appendices

ADDITIONAL MATERIALS FOR SKILLS 2

The following additional materials are needed for the lessons in Unit 2; the number in parentheses indicates the first lesson in which the item is used:

- chart paper (1)
- small pieces of crayons for all students (1)
- soft modeling clay for all students (1)
- a puppet or stuffed animal (4)
- tracing paper or plastic sheet protectors (5)

* If plastic sheet protectors are used, dry-erase markers or grease pencils will be needed for all students.

- Digital Components: Throughout this unit and others, whenever the lesson suggests the teacher model the completion of an activity page or prepare a chart to display, you may use the digital version on the program's digital components site. (1)

PREREQUISITE SKILLS

Blending and Prewriting

PRIMARY FOCUS OF LESSON

Prerequisite Foundational Skills

Students will identify, blend, and manipulate syllables to form multisyllabic words by using hand gestures and by playing a game involving large motor

skills. **TEKS K.1.B; TEKS K.2.A.iv; TEKS K.2.A.v; TEKS K.2.A.ix**

Students will demonstrate print awareness by tracking pictures on a page left to

right with return sweep. **TEKS K.2.D.ii**

Prerequisite Writing Skills

Students will strengthen fine motor muscles by shaping modeling clay into cups and by holding a writing utensil with a tripod (or pincer) grip and drawing cups.

Prerequisite Skill

Students will use spatial words, such as *top* and *bottom*, while practicing

handwriting. **Prerequisite Skill; TEKS K.3.C**

FORMATIVE ASSESSMENT

Observation

Oral Blending Observation Record

TEKS K.2.A.iv; TEKS K.2.A.v; TEKS K.2.A.ix

Activity Page 1.2

Cup Practice

Prerequisite Skill

TEKS K.1.B Restate and follow oral directions that involve a short, related sequence of actions; **TEKS K.2.A** Demonstrate phonological awareness by: (iv) identifying syllables in spoken words; (v) blending syllables to form multisyllabic words; (ix) manipulating syllables within a multisyllabic word; **TEKS K.2.D.ii** Demonstrate print awareness by holding a book right side up, turning pages correctly, and knowing that reading moves from top to bottom and left to right with return sweep; **TEKS K.3.C** Identify and use words that name actions; directions; positions; sequences; categories such as colors, shapes, and textures; and locations.

LESSON AT A GLANCE

	Grouping	Time	Materials
Prerequisite Foundational Skills			
Warm-Up: Syllable Blending (Phonological Awareness)	Whole Group	5 min.	
Practice Blending: Tap and Chase (Phonological Awareness)	Whole Group	10 min.	
Track from Left to Right and Top to Bottom (Print Concepts)	Whole Group	10 min.	<input type="checkbox"/> Activity Page 1.1
Prerequisite Writing Skills			
Fine Motor Skills: Make Cups with Modeling Clay	Whole Group	10 min.	<input type="checkbox"/> modeling clay
Draw Cups on a Vertical Surface	Whole Group	10 min.	<input type="checkbox"/> crayons <input type="checkbox"/> chart paper
Cup Practice	Independent	15 min.	<input type="checkbox"/> Activity Page 1.2 <input type="checkbox"/> Activity Page 1.2 (Digital Components)
Take-Home Material			
Cup Practice			<input type="checkbox"/> Activity Page 1.3

ADVANCE PREPARATION

Prerequisite Writing Skills

- Provide each student with a piece of modeling clay for Make Cups with Modeling Clay.
- Provide crayons for students to use and tape multiple pieces of chart paper to the wall at a height that students can reach for Drawing Cups on a Vertical Surface.

➤ Digital Component 1.1

- Create an enlarged version of Activity Page 1.2 to display for Cup Practice, or use the digital version (Digital Component 1.1).

Universal Access

- Bring in pictures of the following words: *cupcake*, *bedroom*, *snowman*, *seashell*, *popcorn*, *rainbow*, *outside*, and *backpack* for the Warm-Up activity.
- Prepare papers with stars at the starting point and dots for the ending point to help students draw lines.
- Provide plain, unlined paper and crayons for students who are able to draw on to use for the challenge in Cup Practice.

Lesson 1: Blending Syllables

Prerequisite Foundational Skills



Primary Focus

Students will identify, blend, and manipulate syllables to form multisyllabic words by using hand gestures and by playing a game involving large motor

✦ skills. **TEKS K.1.B; TEKS K.2.A.iv; TEKS K.2.A.v; TEKS K.2.A.ix**

Students will demonstrate print awareness by tracking pictures on a page left to

✦ right with a return sweep. **TEKS K.2.D.ii**

WARM-UP (5 MIN.)

Note: This Warm-Up gives students practice blending syllables. It is repeated in Lesson 2. In Lesson 3, students will blend syllables and then sounds during the Warm-Up. In Lessons 4–10, they will only blend sounds.

✦ **Syllable Blending** **TEKS K.2.A.iv; TEKS K.2.A.v; TEKS K.2.A.ix**

Note: In this activity, you will use your right hand first, then your left, so from students' point of view the motions will occur from left to right. The illustrations for this activity show your actions from the students' point of view. Encourage students to mirror your actions, using their left hand first, then their right. It may be helpful to review left hand/right hand with students before beginning this exercise.

- Hold your fists in front of you, palms facing down (see illustration 1).
- Say the word *one* as you flip over your right fist and open it (see illustration 2).
- Say the word *two* as you flip over your left fist and open it (see illustration 3).
- Say the word *blend* as you clap your hands (see illustration 4). Practice this with the class.



✦ **TEKS K.1.B** Restate and follow oral directions that involve a short, related sequence of actions; **TEKS K.2.A** Demonstrate phonological awareness by: (iv) identifying syllables in spoken words; (v) blending syllables to form multisyllabic words; (ix) manipulating syllables within a multisyllabic word; **TEKS K.2.D.ii** Demonstrate print awareness by holding a book right side up, turning pages correctly, and knowing that reading moves from top to bottom and left to right with return sweep.

- Tell the class the word *cupcake* has two sound parts. Say the syllables in a segmented fashion: *cup . . . cake*.
- Hold your fists in front of you, palms facing down. Remember to stand with your back facing students when modeling the blending procedure.
- Say the syllable *cup* as you flip over your right fist and open it.
- Say the syllable *cake* as you flip over your left fist and open it.
- Say the word *cupcake* as you clap your hands.

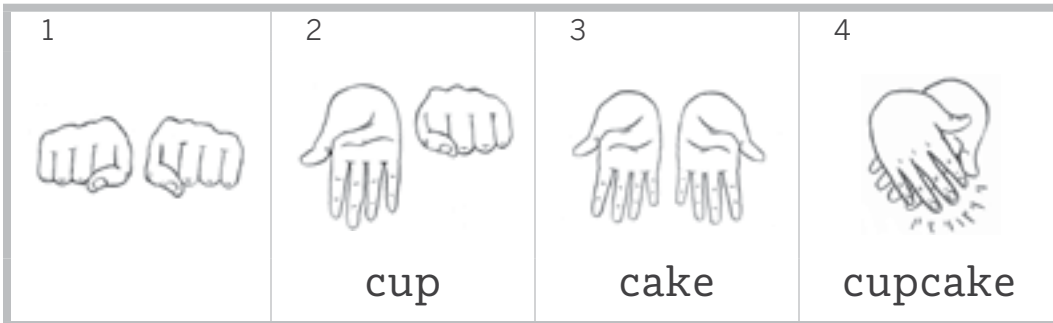

- Practice this with the class.
- Complete the activity using the words listed.

1. cup . . . cake > cupcake	5. pop . . . corn > popcorn
2. bed . . . room > bedroom	6. rain . . . bow > rainbow
3. snow . . . man > snowman	7. out . . . side > outside
4. sea . . . shell > seashell	8. back . . . pack > backpack

PRACTICE BLENDING (10 MIN.)

Tap and Chase **TEKS K.1.B; TEKS K.2.A.iv; TEKS K.2.A.v; TEKS K.2.A.ix**

Note: This exercise will strengthen syllable-blending skills.

- Have students sit in a circle. Tell students they are going to play a game similar to “Duck, Duck, Goose.”
- Tell students you are going to select a student to be “it.” You will tell that student a word (e.g., *sunshine*). Instead of saying “duck, duck, duck, duck,” the student who is “it” should say the two parts of the word separately (e.g., “sun, shine, sun, shine”) as they walk around the circle and tap their classmates’ heads. Instead of saying “goose,” the student who is “it” should say the word blended (e.g., “sunshine”). The rest of the rules are the same as those for “Duck, Duck, Goose.” Demonstrate for students if necessary.

TEKS K.1.B Restate and follow oral directions that involve a short, related sequence of actions; **TEKS K.2.A** Demonstrate phonological awareness by: (iv) identifying syllables in spoken words; (v) blending syllables to form multisyllabic words; (ix) manipulating syllables within a multisyllabic word.



Foundational Skills

Foundational Literacy Skills

When introducing the stimulus words, show pictures of the following words: *cupcake*, *bedroom*, *snowman*, *seashell*, *popcorn*, *rainbow*, *outside*, and *backpack*.

ELPS 4.F

- Call on a few students to restate the directions for the game.

- | | |
|----------------|-----------------|
| 1. sun•shine | 7. back•pack |
| 2. doll•house | 8. meat•ball |
| 3. door•bell | 9. moon•light |
| 4. bed•time | 10. pan•cake |
| 5. play•ground | 11. sail•boat |
| 6. sand•box | 12. wheel•chair |



Observation: Oral Blending Observation Record

As you listen to students blend the syllables, make notes regarding their individual blending ability in the Oral Blending Observation Record.

TRACK FROM LEFT TO RIGHT AND TOP TO BOTTOM (10 MIN.)

Activity Page 1.1



- Distribute Activity Page 1.1.
- Tell students to place their pointer fingers on the first star.
- Ask students, “What is the next picture?”
- Once students have provided the correct answer (*a bird*), direct students to place their pointer fingers on the bird.
- ✚ • Repeat with each of the remaining pictures in the first row. **TEKS K.2.D.ii**
- Tell students to make sure they are pointing their fingers left to right with a return sweep.
- Complete the items in the second, third, and fourth rows. Then complete the items on the back of the activity page.

✚ **TEKS K.2.D.ii** Demonstrate print awareness by holding a book right side up, turning pages correctly, and knowing that reading moves from top to bottom and left to right with return sweep.

Lesson 1: Prewriting

Prerequisite Writing Skills



Primary Focus

Students will strengthen fine motor muscles by shaping modeling clay into cups and by holding a writing utensil with a tripod (or pincer) grip and drawing

✦ cups. **Prerequisite Skill**

Students will use spatial words, such as *top* and *bottom*, while practicing

✦ handwriting. **Prerequisite Skill; TEKS K.3.C**

FINE MOTOR SKILLS (10 MIN.)

Make Cups with Modeling Clay

Note: This exercise is designed to strengthen and improve fine motor skills, and introduce students to the cup shape.

- Provide each student with a piece of modeling clay.
- Model the steps needed to make a line: roll the modeling clay into a ball, place the ball on a flat surface, and roll it into a line.
- Have students make modeling clay lines.
- Demonstrate forming your modeling clay line into a cup.
- Have students make a modeling clay cup.

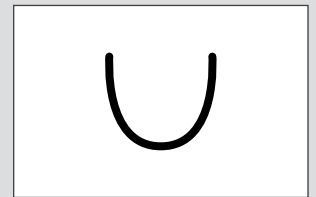

DRAW CUPS ON A VERTICAL SURFACE (10 MIN.)

Note: Drawing cups will prepare students to write letters such as 'u' and 'U'.

- Review the position words *top*, *bottom*, *left*, *right*, and *middle* with students, pointing out the top, bottom, left side, right side, and middle of one of the pieces of chart paper.
- Draw a cup on the board/chart paper. Explain that a cup is made by drawing a vertical line down, a curve to the right, and a vertical line up. Point out that a cup looks a lot like a drinking cup.

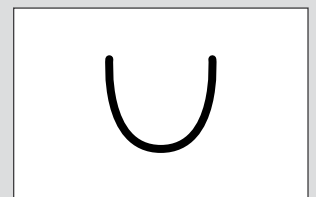

✦ **TEKS K.3.C** Identify and use words that name actions; directions; positions; sequences; categories such as colors, shapes, and textures; and locations.

Support

If students have trouble drawing cups, you may draw stars on the paper to indicate where they should start each cup and dots to indicate where they should stop each cup.

Activity Page 1.2



Challenge

Encourage students to practice the handwriting strokes on plain paper without dotted lines as guides.

- Invite students to trace cups on their desks or in the air with their fingers.
- Have students draw cups on the chart paper.
- Circulate, correcting grips and assisting students as they draw cups.

CUP PRACTICE (15 MIN.)

- Have students settle into the proper writing posture (feet parallel and touching the floor, backs straight).

➤ Digital Component 1.1

- Distribute and display Activity Page 1.2.
- Explain that the activity page shows some children jumping rope, but each child is missing his or her jump rope.
- Tell students you are going to give each child a jump rope. They should do the same on their activity pages.
- Show students how to give one of the children a jump rope by tracing the dotted line. As you draw, explain that you are giving the child a jump rope by drawing a cup, starting at the star.
- Continue demonstrating (providing guided practice) until students are ready to work independently.
- Tell students that once they have finished the front of the activity page, they should complete the back of the page.
- Students may color the pictures and/or draw a picture containing at least one cup if time permits.



Activity Page 1.2: Cup Practice

Collect Activity Page 1.2 to review and monitor students' ability to complete the task.

Take-Home Material

CUP PRACTICE

- Have students give Activity Page 1.3 to a family member.

Activity Page 1.3



Lesson 1: Prerequisite Foundational Skills Remediation

Additional Support

MORE HELP WITH BLENDING SYLLABLES

Compound Word Pictures

- Make one copy of **Activity Pages TR 1.1 and TR 1.2** for each student.
- Show students the goldfish equation on the first page.
- Have students cut out the picture cards along the dotted lines and shuffle the cards.
- Have students combine the picture cards to form compound words and fill in the set of equation boxes.
- Possible compound words include:

- | | |
|----------------|--------------|
| 1. base•ball | 3. foot•ball |
| 2. basket•ball | 4. rail•road |

2

PREREQUISITE SKILLS

Blending and Prewriting

PRIMARY FOCUS OF LESSON

Prerequisite Foundational Skills

Students will blend syllables and sounds to form words by using hand gestures and by playing a game involving large motor skills.

✦ **TEKS K.1.B; TEKS K.2.A.v; TEKS K.2.A.viii**

Prerequisite Writing Skills

Students will strengthen fine motor muscles by shaping modeling clay into humps and by holding a writing utensil with a tripod (or pincer) grip and drawing humps.

✦ **Prerequisite Skill**

Students will use spatial words, such as *top* and *bottom*, while practicing

✦ handwriting. **Prerequisite Skill; TEKS K.3.C**

FORMATIVE ASSESSMENT

Observation

Oral Blending Observation Record

✦ **TEKS K.2.A.v; TEKS K.2.A.viii**

Activity Page 2.1

Hump Practice

✦ **Prerequisite Skill**

✦ **TEKS K.1.B** Restate and follow oral directions that involve a short, related sequence of actions; **TEKS K.2.A** Demonstrate phonological awareness by: (v) blending syllables to form multisyllabic words; (viii) blending spoken phonemes to form one-syllable words; **TEKS K.3.C** Identify and use words that name actions; directions; positions; sequences; categories such as colors, shapes, and textures; and locations.

LESSON AT A GLANCE

	Grouping	Time	Materials
Prerequisite Foundational Skills			
Warm-Up: Syllable Blending (Phonological Awareness)	Whole Group	5 min.	
Practice Blending: - Tap and Chase - Blend Syllables and Sounds (Phonological Awareness)	Whole Group	20 min.	
Prerequisite Writing Skills			
Fine Motor Skills: Make Humps with Modeling Clay	Whole Group	10 min.	<input type="checkbox"/> modeling clay
Draw Humps on a Vertical Surface	Whole Group	10 min.	<input type="checkbox"/> crayons <input type="checkbox"/> chart paper
Hump Practice	Independent	15 min.	<input type="checkbox"/> Activity Page 2.1 <input type="checkbox"/> Activity Page 2.1 (Digital Components)
Take-Home Material			
Hump Practice			<input type="checkbox"/> Activity Page 2.2

ADVANCE PREPARATION

Note to Teacher

In this lesson, you will help students make the transition between syllable blending and sound blending. This is a very important transition because our writing system uses symbols to stand for sounds (not syllables). Please thoroughly familiarize yourself with the exercise called “Blend Syllables and Sounds” on page 21 before teaching this lesson.

Prerequisite Writing Skills

- Provide each student with a piece of modeling clay for Making Humps with Modeling Clay.
- Provide crayons for students to use and tape multiple pieces of chart paper to the wall at a height that students can reach for Draw Humps on a Vertical Surface.

➤ Digital Component 2.1

- Create an enlarged version of Activity Page 2.1 to display for Hump Practice, or use the digital version (Digital Component 2.1).

Universal Access

- Bring in pictures of the following words: *cupcake*, *bedroom*, *snowman*, *seashell*, *popcorn*, *rainbow*, *outside*, and *backpack* for the Warm-Up activity.
- Prepare papers with stars at the starting point and dots for the ending point to help students draw lines.

Lesson 2: Blending

Prerequisite Foundational Skills



Primary Focus: Students will blend syllables and sounds to form words by using hand gestures and by playing a game involving large motor skills.

TEKS K.1.B; TEKS K.2.A.v; TEKS K.2.A.viii

WARM-UP (5 MIN.)

Syllable Blending

Note: In this exercise, you will use your right hand first, then your left, so that from students point of view the motions will occur from left to right. The illustrations for this activity show your actions from the students' point of view. Encourage students to mirror your actions, using their left hand first, then their right. It may be helpful to review left hand/right hand with students before beginning this exercise.

- Hold your fists in front of you, palms facing down (see illustration 1).
- Say the word *one* as you flip over your right fist and open it (see illustration 2).
- Say the word *two* as you flip over your left fist and open it (see illustration 3).
- Say the word *blend* as you clap your hands (see illustration 4). Practice this with the class.
- Tell the class the word *cupcake* has two sound parts. Say the syllables in a segmented fashion: *cup . . . cake*.
- Hold your fists in front of you, palms facing down. Remember to stand with your back facing students when modeling the blending procedure.
- Say the syllable *cup* as you flip over your right fist and open it.
- Say the syllable *cake* as you flip over your left fist and open it.

TEKS K.1.B Restate and follow oral directions that involve a short, related sequence of actions; **TEKS K.2.A** Demonstrate phonological awareness by: (v) blending syllables to form multisyllabic words; (viii) blending spoken phonemes to form one-syllable words.



Foundational Skills

Foundational Literacy Skills

When introducing the stimulus words, show pictures of the following: *cupcake*, *bedroom*, *snowman*, *seashell*, *popcorn*, *rainbow*, *outside*, and *backpack*.

ELPS 4.F

- Say the word *cupcake* as you clap your hands.

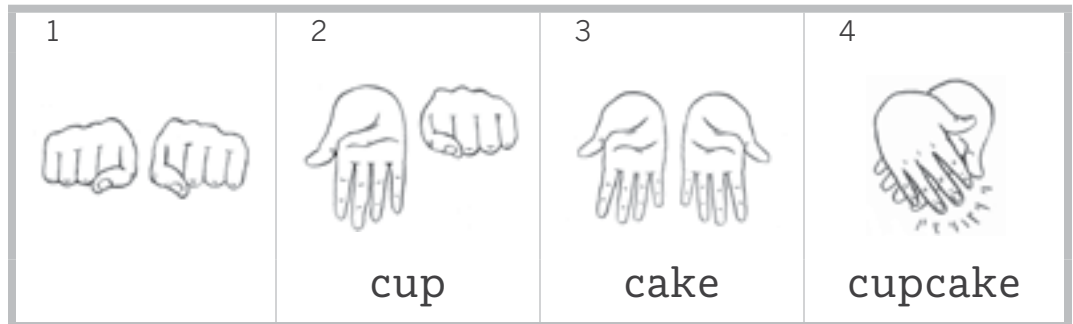

- Practice this with the class.
- Complete the activity using the words listed.

- | | |
|-------------------------------|-------------------------------|
| 1. cup . . . cake > cupcake | 5. pop . . . corn > popcorn |
| 2. bed . . . room > bedroom | 6. rain . . . bow > rainbow |
| 3. snow . . . man > snowman | 7. out . . . side > outside |
| 4. sea . . . shell > seashell | 8. back . . . pack > backpack |

PRACTICE BLENDING (20 MIN.)

Tap and Chase

- Have students sit in a circle. Tell students they are going to play a game similar to “Duck, Duck, Goose.”
- Tell students you are going to select a student to be “it.” You will tell that student a word (e.g., *sunshine*). Instead of saying, “duck, duck, duck, duck,” the student who is “it” should say the two parts of the word separately (e.g., “sun, shine, sun, shine”) as they walk around the circle and tap their classmates’ heads. Instead of saying “goose,” the student who is “it” should say the word blended (e.g., “sunshine”). The rest of the rules are the same as those for “Duck, Duck, Goose.” Demonstrate for students if necessary.
- Call on a few students to restate the directions for the game.

- | | |
|---------------|---------------|
| 1. swing•set | 6. o•ver |
| 2. bath•room | 7. Fri•day |
| 3. snow•flake | 8. po•ny |
| 4. in•side | 9. sen•tence |
| 5. friend•ly | 10. base•ball |

Blend Syllables and Sounds

Note: This exercise is intended to help students make the important transition from blending syllables to blending sounds. The gestures and the number of items are held constant, but the components that are blended shift from syllables to sounds.

- Remind students of the hand gestures they used in the Warm-Up when combining syllables.
- Hold your fists in front of you, palms facing down. Remember to stand with your back facing students when modeling the blending procedure.
- Say the word *ant* as you flip over your left fist and open it.
- Say the word *hill* as you flip over your right fist and open it.
- Say the word *anthill* as you clap your hands.
- Practice this with students.
- Repeat these procedures for each of the two-syllable words listed in the following table:

1. ant•hill	3. barn•yard
2. class•room	4. back•pack

- Once students have successfully blended the syllables listed above, explain that words are made up of sounds, and sounds can be combined in the same manner as syllables.
- Say the sound /n/ as you flip over your left fist and open it.
- Say the sound /oe/ as you flip over your right fist and open it.
- Say the word *no* as you clap your hands.
- Practice this with students.
- Repeat these procedures for each of the two-sound words listed in the following table:

Note: Please refer to Appendix A for the phoneme transcription system.

- | | |
|-------------------------|------------------------|
| 1. /n/ ... /oe/ > no | 4. /m/ ... /ee/ > me |
| 2. /sh/ ... /oo/ > shoe | 5. /n/ ... /ee/ > knee |
| 3. /z/ ... /oo/ > zoo | 6. /o/ ... /f/ > off |



Observation: Oral Blending Observation Record

As you listen to students blend the syllables and sounds, make notes regarding their individual blending ability in the Oral Blending Observation Record.

Lesson 2: Prewriting

Prerequisite Writing Skills



Primary Focus

Students will strengthen fine motor muscles by shaping modeling clay into humps and by holding a writing utensil with a tripod (or pincer) grip and drawing

✦ humps. **Prerequisite Skill**

Students will use spatial words, such as *top* and *bottom*, while practicing

✦ handwriting. **Prerequisite Skill; TEKS K.3.C**

FINE MOTOR SKILLS (10 MIN.)

Make Humps with Modeling Clay

Note: This exercise is designed to strengthen students' fingers, advance their fine motor skills, and introduce them to the hump shape.

- Provide each student with a piece of modeling clay.
- Model the steps to make a line: roll the modeling clay into a ball, place the ball on a flat surface, and roll it into a line.
- Have students make modeling clay lines.

✦ **TEKS K.3.C** Identify and use words that name actions; directions; positions; sequences; categories such as colors, shapes, and textures; and locations.

- Demonstrate curving your modeling clay line into a hump. Be sure to call attention to the position of the curved part at the top. Some students may recognize that the hump is an upside-down cup.
- Have students make modeling clay humps.

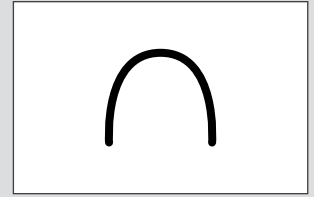

DRAW HUMPS ON A VERTICAL SURFACE (10 MIN.)

Note: Drawing humps will prepare students to write letters such as ‘h,’ ‘m,’ and ‘n.’

- Review the position words *top*, *bottom*, *left*, *right*, and *middle* with students, pointing out the top, bottom, left side, right side, and middle of one of the pieces of chart paper.
- Draw a hump on the board/chart paper. Explain that a hump is made by drawing a vertical line up, a curve to the right, and a vertical line down.
- Invite students to trace humps on their desks or in the air with their fingers.
- Have students draw humps on the chart paper.
- Circulate, correcting grips and assisting students as they draw humps.

Support

If students have trouble drawing humps, you may draw stars on the paper to indicate where they should start each hump and dots to indicate where they should stop each hump.

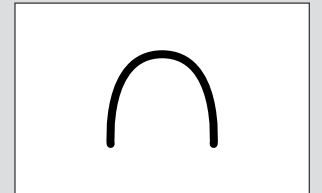

HUMP PRACTICE (15 MIN.)

- Have students settle into the proper writing posture (feet parallel and touching the floor, backs straight).

➤ Digital Component 2.1

- Distribute and display Activity Page 2.1.
- Explain the activity page: it shows some camels, but each camel’s hump is missing.
- Tell students you are going to complete each camel. They should do the same on their activity pages.
- Show students how to complete one of the camels by tracing the dotted line. As you draw, explain that you are completing the camel by drawing a hump, starting at the star.
- Continue demonstrating (providing guided practice) until students are ready to work independently.
- Tell students once they have finished the front of the activity page, they should complete the back of the page.

Challenge

Invite students to name some hump-shaped objects (e.g., rainbows, umbrellas, hills, a camel’s back, etc.). Have students draw something having a hump shape.

Activity Page 2.1



- Students may color the pictures and/or draw a picture containing at least one hump if time permits.



Activity Page 2.1: Hump Practice

Collect Activity Page 2.1 to review and monitor students' ability to complete the task.

End Lesson

Take-Home Material

HUMP PRACTICE

- Have students give Activity Page 2.2 to a family member.

Activity Page 2.2



Lesson 2: Prerequisite Foundational Skills Remediation

Additional Support

MORE HELP WITH BLENDING SYLLABLES

Compound Word Pictures

- Make one copy of **Activity Pages TR 1.1 and 2.1** for each student.
- Follow the procedure outlined in Lesson 1.
- Possible compound words include:

- | | |
|---------------|----------------|
| 1. fire•fly | 3. skate•board |
| 2. butter•fly | 4. key•board |

MORE HELP WITH FINE MOTOR ACTIVITIES

Lines in the Sand

- Provide students with shallow trays of sand.
- Write a variety of lines and shapes—horizontal, vertical and diagonal lines, geometric shapes, and humps—on the board/chart paper one at a time for students to duplicate by using a finger in the sand.

PREREQUISITE SKILLS

Blending and Prewriting

PRIMARY FOCUS OF LESSON

Prerequisite Foundational Skills

Students will identify and blend syllables and sounds to form multisyllabic words by using hand gestures, large motor gestures, and visual supports.

✦ **TEKS K.1.B; TEKS K.2.A.iv; TEKS K.2.A.v; TEKS K.2.A.viii**

Students will blend spoken onsets, rimes, and phonemes to form one-syllable

✦ words. **TEKS K.2.A.vii; TEKS K.2.A.viii**

Prerequisite Writing Skills

Students will identify and use words that name categories such as colors, shapes, and textures; and locations. **Prerequisite Skill; TEKS K.3.C**

✦

Students will hold a writing utensil with a tripod (or pincer) grip and draw zigzags.

✦ **Prerequisite Skill**

Students will use spatial words, such as *top*, *bottom*, *left*, *right*, and *middle*, while

✦ practicing handwriting. **Prerequisite Skill; TEKS K.3.C**

FORMATIVE ASSESSMENT

Observation

Oral Blending Observation Record

✦ **TEKS K.2.A.v; TEKS K.2.A.viii**

Activity Page 3.2

Differentiating Shapes

✦ **Prerequisite Skill**

✦ **TEKS K.1.B** Restate and follow oral directions that involve a short, related sequence of actions. **TEKS K.2.A** Demonstrate phonological awareness by: (iv) identifying syllables in spoken words; (v) blending syllables to form multisyllabic words; (vii) blending spoken onsets and rimes to form simple words; (viii) blending spoken phonemes to form one-syllable words; **TEKS K.3.C** identify and use words that name actions; directions; positions; sequences; categories such as colors, shapes, and textures; and locations.

LESSON AT A GLANCE

	Grouping	Time	Materials
Prerequisite Foundational Skills			
Warm-Up: Syllable and Sound Blending (Phonological Awareness)	Whole Group	5 min.	
Practice Blending: - Blending Gestures - Picture Card Blending (Phonological Awareness)	Whole Group	20 min.	<input type="checkbox"/> Blending Picture Cards for <i>sun, mouth, nose, knife</i>
Prerequisite Writing Skills			
Draw Zigzags on a Vertical Surface	Whole Group	10 min.	<input type="checkbox"/> crayons <input type="checkbox"/> chart paper
Zigzag Practice	Whole Group/ Independent	15 min.	<input type="checkbox"/> Activity Page 3.1 <input type="checkbox"/> Activity Page 3.1 (Digital Components)
Differentiate Shapes	Whole Group/ Independent	10 min.	<input type="checkbox"/> Activity Page 3.2 <input type="checkbox"/> Activity Page 3.2 (Digital Components)
Take-Home Material			
Trace Shapes			<input type="checkbox"/> Activity Page 3.3

ADVANCE PREPARATION

Prerequisite Foundational Skills

- Gather the Blending Picture Cards for *sun*, *mouth*, *nose*, and *knife*.

Prerequisite Writing Skills

- Provide crayons for students to use and tape multiple pieces of chart paper to the wall at a height that students can reach for Draw Zigzags on a Vertical Surface.

➤ Digital Component 3.1

- Create an enlarged version of Activity Page 3.1 to display for Zigzag Practice, or use the digital version (Digital Component 3.1).

➤ Digital Component 3.2

- Create an enlarged version of Activity Page 3.2 to display for Differentiate Shapes, or use the digital version (Digital Component 3.2).

Universal Access

- Bring in pictures of the following words: *bathtub*, *pencil*, *windy*, and *sister* for the Warm-Up activity.
- Prepare papers with stars at the starting point and dots for the ending point to help students draw lines.

Lesson 3: Blending

Prerequisite Foundational Skills



Primary Focus

Students will identify and blend syllables and sounds to form multisyllabic words by using hand gestures, large motor gestures, and visual supports.

✦ **TEKS K.1.B; TEKS K.2.A.iv; TEKS K.2.A.v; TEKS K.2.A.viii**

Students will blend spoken onsets, rimes, and phonemes to form one-syllable

✦ words. **TEKS K.2.A.vii; TEKS K.2.A.viii**

WARM-UP (5 MIN.)

✦ **Syllable and Sound Blending** **TEKS K.2.A.iv; TEKS K.2.A.v**

Note: Use the motions described in the Lesson 1 Warm-Up. Encourage students to mirror your actions, using their left hand first, then their right. It may be helpful to review left hand/right hand with students before beginning this exercise. The illustrations for this activity show your actions from the students' point of view.

- Hold your fists in front of you, palms facing down.
- Say the word *bath* as you flip over your left fist and open it.
- Say the word *tub* as you flip over your right fist and open it.
- Say the word *bathtub* as you clap your hands.
- Practice with students.

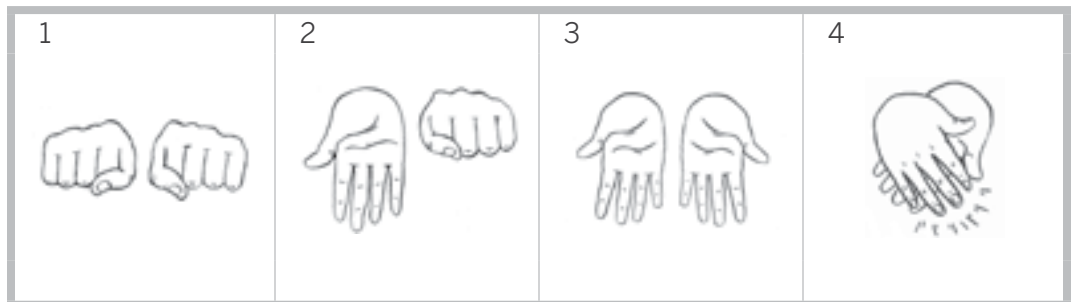

- Repeat these procedures for each of the two-syllable words listed in the following box:

✦ **TEKS K.1.B** Restate and follow oral directions that involve a short, related sequence of actions; **TEKS K.2.A** Demonstrate phonological awareness by: (iv) identifying syllables in spoken words; (v) blending syllables to form multisyllabic words; (vii) blending spoken onsets and rimes to form simple words; (viii) blending spoken phonemes to form one-syllable words.

- | | |
|-------------|------------|
| 1. bath•tub | 3. wind•y |
| 2. pen•cil | 4. sis•ter |

- Once students have successfully blended the syllables, explain that words are made up of sounds and sounds can be combined in the same way as syllables.
- Say the sound /sh/ as you flip over your left fist and open it.
- Say the sound /ee/ as you flip over your right fist and open it.
- Say the word *she* as you clap your hands.
- Practice this with students.
- Repeat these procedures for each of the two-sound words listed in the following box:

- | | |
|-------------------------|-----------------------|
| 1. /sh/ ... /ee/ > she | 3. /z/ ... /oo/ > zoo |
| 2. /sh/ ... /oo/ > shoe | 4. /o/ ... /f/ > off |

PRACTICE BLENDING (20 MIN.)

Blending Gestures **TEKS K.2.A.vii; TEKS K.2.A.viii**

Note: There is an additional set of blending motions described in the Appendix. This second set of blending motions involves tapping the fingers to the thumb and then making a fist. Please feel free to use the finger-blending motions instead of the arm-blending motions. Some teachers prefer the finger-blending motions because they feel the finger-blending motions are more conducive to blending longer words.

- Tell students clap-blending works well when you are blending two syllables or two sounds. It does not work when you blend three or more sounds.
- Explain that you will be teaching students new gestures they can use when they blend three sounds.
- Stand in front of the class so students can mirror your actions.
- Hold your left arm in front of your body.
- Say the word *one* as you touch your left shoulder with your right hand (see illustration 1).
- Say the word *two* as you touch the inside of your left elbow with your right hand (see illustration 2).
- Say the word *three* as you touch your left wrist with your right hand (see illustration 3).

 **TEKS K.2.A** Demonstrate phonological awareness by: (vii) blending spoken onsets and rimes to form simple words; (viii) blending spoken phonemes to form one-syllable words.



**ENGLISH
LANGUAGE
LEARNERS**

Foundational Skills

Foundational Literacy Skills

When introducing the stimulus words, show pictures of the following: *bathtub*, *pencil*, *windy*, and *sister*.

ELPS 4.F

- Say the word *blend* as you slide your right hand from your left shoulder down to your left wrist (see illustration 4).
- Practice this with students.

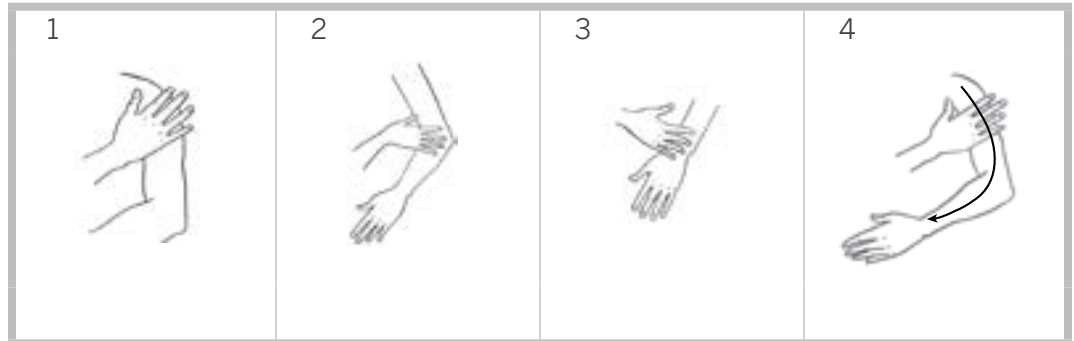

- Tell the class the word *fun* has three sounds. Say the sounds in a segmented fashion: /f/ ... /u/ ... /n/.
- Say the sound /f/ as you touch your left shoulder with your right hand.
- Say the sound /u/ as you touch your left elbow with your right hand.
- Say the sound /n/ as you touch your left wrist with your right hand.
- Say the word *fun* as you slide your right hand from your left shoulder down to your left wrist.
- Practice this with students.
- Complete the remaining words.

Note: You are blending sounds without calling attention to the number of letters in a word.

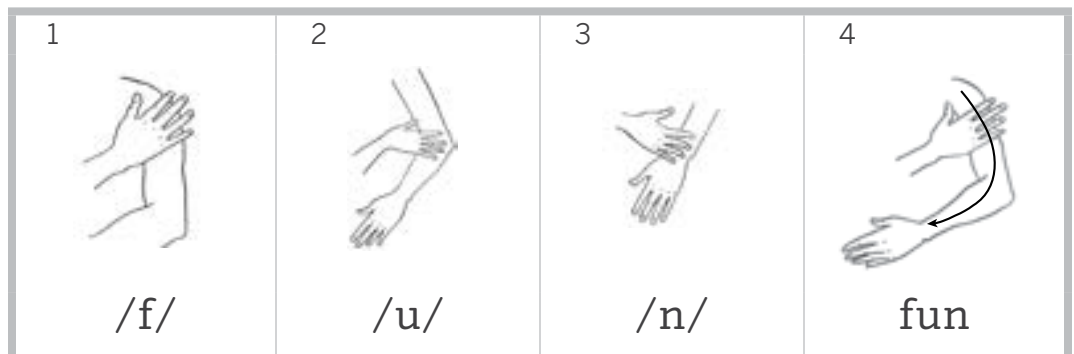

- | | |
|--------------------------------|--------------------------------|
| 1. /f/ ... /u/ ... /n/ > fun | 4. /s/ ... /ie/ ... /n/ > sign |
| 2. /m/ ... /e/ ... /s/ > mess | 5. /m/ ... /ee/ ... /n/ > mean |
| 3. /f/ ... /i/ ... /sh/ > fish | 6. /z/ ... /oo/ ... /m/ > zoom |

Picture Card Blending **TEKS K.2.A.vii; TEKS K.2.A.viii**

- Using the Blending Picture Cards you prepared in advance, show the first picture to students and say, “This is the sun.”
- Tell the class the word *sun* contains three sounds.
- Say /s/ as you touch your shoulder.
- Say /u/ as you touch your elbow.
- Say /n/ as you touch your wrist.
- Say *sun* as you sweep your hand down your arm. Have students do the same.
- Place the picture of the mouth next to the picture of the sun. Repeat the procedures outlined above with the word *mouth*.
- Displaying both pictures, ask the class if they can find the picture of the /m/ ... /ou/ ... /th/. (Say the word in a segmented fashion, with a one-second pause between the sounds.)
- Ask students to find the picture of the /s/ ... /u/ ... /n/.
- Remove the pictures of the sun and the mouth and repeat the above procedures with the next two pictures (*nose* and *knife*).
- Display all four pictures and ask the class to find one of them, while you say the word in a segmented fashion. Repeat until all four pictures have been identified.



Observation: Oral Blending Observation Record

As you listen to students blend the sounds, make notes regarding their individual blending ability in the Oral Blending Observation Record.

Blending Picture Cards



Challenge

Look for other opportunities during the school day to segment words students can then blend (e.g., when calling on Ben, ask for /b/ ... /e/ ... /n/; when it is time for gym, say it is time for /j/ ... /i/ ... /m/).

 **TEKS K.2.A** Demonstrate phonological awareness by: (vii) blending spoken onsets and rimes to form simple words; (viii) blending spoken phonemes to form one-syllable words.

Lesson 3: Prewriting

Prerequisite Writing Skills



Primary Focus

Students will identify and use words that name categories such as colors, shapes, and textures; and locations. **Prerequisite Skill; TEKS K.3.C**

Students will hold a writing utensil with a tripod (or pincer) grip and draw zigzags.

Prerequisite Skill

Students will use spatial words, such as *top*, *bottom*, *left*, *right*, and *middle*, while practicing handwriting. **Prerequisite Skill; TEKS K.3.C**

DRAW ZIGZAGS ON A VERTICAL SURFACE (10 MIN.)

Note: Drawing zigzags will prepare students to write letters such as 'w,' 'z,' 'N,' and 'M.'

- Review the position words *top*, *bottom*, *left*, *right*, and *middle* with students, pointing out the top, bottom, left side, right side, and middle of one of the pieces of chart paper.
- Draw a zigzag on the board/chart paper. Explain that a zigzag is made up of a series of diagonal lines made without lifting the crayon from the paper.
- Invite students to trace zigzags on their desks or in the air with their fingers.
- Have students draw zigzags on the chart paper.
- Circulate, correcting grips and assisting students as they draw zigzags.

ZIGZAG PRACTICE (15 MIN.)

- Have students settle into the proper writing posture.

➤ Digital Component 3.1

- Distribute and display Activity Page 3.1.
- Explain that the activity page shows animals and their homes.
- Tell students you are going to draw a line from each animal to its home. They should do the same on their activity pages.

TEKS K.3.C Students will identify and use words that name categories such as colors, shapes, and textures; and locations.



Support

If students have trouble drawing zigzags, you may draw stars on the paper to indicate where they should start each zigzag and dots to indicate where they should stop.

Activity Page 3.1



- Show students how to trace the dotted lines. As you draw, explain that you are connecting each animal to its home by drawing a zigzag, starting at the star.
- Provide guided practice by continuing to demonstrate until students are able to work independently.
- Tell students that once they have finished the front of the activity page, they should complete the back of the activity page.
- Students may color the pictures and/or draw a picture containing at least one zigzag, if time permits.

DIFFERENTIATE SHAPES (10 MIN.)

➤ Digital Component 3.2 **TEKS K.3.C**

- Distribute and display Activity Page 3.2.
- Point to the first row, and ask students which shape is the same as the one on the left and which is different.
- Circle the matching shape and have students do the same on their activity pages.
- Cross out the different shape and have students do the same on their activity pages.
- Provide guided practice by continuing to demonstrate until students are ready to work independently.
- Complete the back of the activity page in the same way. (Do not refer to any of the items as letters or by their letter name. Simply call them shapes.)
- Circulate the room, correcting grips and assisting students.

Activity Page 3.2



Activity Page 3.2: Differentiating Shapes

Collect Activity Page 3.2 to review and monitor students' ability to identify same and different shapes.

➤ **TEKS K.3.C** Identify and use words that name actions; directions; positions; sequences; categories such as colors, shapes, and textures; and locations.

Take-Home Material

TRACE SHAPES

- Have students give Activity Page 3.3 to a family member.

Activity Page 3.3



Lesson 3: Prerequisite Foundational Skills Remediation

Additional Support

MORE HELP WITH BLENDING SYLLABLES

Compound Word Pictures

- Make one copy of **Activity Pages TR 1.1 and TR 3.1** for each student.
- Follow the procedure outlined in Lesson 1.
- Possible compound words include:

- | | |
|---------------|-----------------|
| 1. pop•corn | 3. sun•flower |
| 2. tooth•pick | 4. rattle•snake |

MORE HELP WITH ORAL BLENDING

Find My Word

- Make one copy of **Activity Page TR 3.2** for each student.
- Review the names of the depicted items with students (*cow, dog, duck, horse, bee, pig, cat, sheep, and bird*). Ask if students can identify the category for the page (animals).

- Pronounce the names of the animals by saying the phonemes with a pause in between (e.g., /d/ [pause] /o/ [pause] /g/).
- Have students echo you and point to the corresponding animal pictures.
- Encourage students to use the blending motions they have learned to help them blend the sounds.
- **Variation:** Students can use manipulatives to cover the pictures as they are identified.
- **Variation:** Students can independently practice segmenting phonemes in the names of the objects shown on the page. It is recommended that you ask students to identify phonemes for the objects from left to right and top to bottom to reinforce their understanding of directionality for tracking.

4

PREREQUISITE SKILLS

Blending and Prewriting

PRIMARY FOCUS OF LESSON

Prerequisite Foundational Skills

Students will blend syllables and sounds to form words by using large motor gestures and/or visual supports. **TEKS K.2.A.v; TEKS K.2.A.viii**

Students will listen to one-syllable words and begin to discern initial sounds. **TEKS K.2.A.x**

Prerequisite Writing Skills

Students will hold a writing utensil with a tripod (or pincer) grip and draw wavy lines. **Prerequisite Skill**

Students will use spatial words, such as *top*, *bottom*, *left*, *right*, and *middle*, while practicing handwriting. **TEKS K.3.C**

Students will demonstrate understanding of directionality by recognizing the beginning and end of a row. **TEKS K.2.D.ii**

FORMATIVE ASSESSMENT

Observation

Oral Blending Observation Record

✦ **TEKS K.2.A.v; TEKS K.2.A.viii**

Activity Page 4.1

Wavy Line Practice

✦ **Prerequisite Skill**

✦ **TEKS K.2.A** Demonstrate phonological awareness by: (v) blending syllables to form multisyllabic words; (viii) blending spoken phonemes to form one-syllable words; (x) segmenting spoken one-syllable words into individual phonemes; **TEKS K.3.C** identify and use words that name actions; directions; positions; sequences; categories such as colors, shapes, and textures; and locations. **TEKS K.2.D.ii** Demonstrate print awareness by holding a book right side up, turning pages correctly, and knowing that reading moves from top to bottom and left to right with return sweep.

LESSON AT A GLANCE

	Grouping	Time	Materials
Prerequisite Foundational Skills			
Warm-Up: Sound Blending (Phonological Awareness)	Whole Group	5 min.	
Practice Blending: Picture Card Blending (Phonological Awareness)	Whole Group	10 min.	<input type="checkbox"/> Blending Picture Cards for <i>fish</i> , <i>five</i> , <i>rose</i> , <i>moon</i>
Listening for Beginning Sounds: Mixed-Up Monster (Phonological Awareness)	Whole Group	10 min.	<input type="checkbox"/> puppet
Prerequisite Writing Skills			
Draw Wavy Lines on a Vertical Surface	Whole Group	10 min.	<input type="checkbox"/> crayons <input type="checkbox"/> chart paper
Wavy Line Practice	Whole Group/ Independent	15 min.	<input type="checkbox"/> Activity Page 4.1 <input type="checkbox"/> Activity Page 4.1 (Digital Components)
Left-to-Right Directionality: Beginning/End Recognition	Whole Group/ Independent	10 min.	<input type="checkbox"/> crayons <input type="checkbox"/> Activity Page 4.2 <input type="checkbox"/> Activity Page 4.2 (Digital Components)
Take-Home Material			
Trace Shapes			<input type="checkbox"/> Activity Page 4.3

ADVANCE PREPARATION

Prerequisite Foundational Skills

- Gather the Blending Picture Cards for *fish*, *five*, *rose*, and *moon*.
- Provide a puppet for Mixed-Up Monster.

Prerequisite Writing Skills

- Provide crayons for students to use and tape multiple pieces of chart paper to the wall at a height that students can reach for the Drawing Wavy Lines on a Vertical Surface activity.

➤ Digital Component 4.1

- Create an enlarged version of Activity Page 4.1 to display for Wavy Line Practice, or use the digital version (Digital Component 4.1).

➤ Digital Component 4.2

- Create an enlarged version of Activity Page 4.2 to display for Beginning/End Recognition, or use the digital version (Digital Component 4.2).

Universal Access

- Prepare pictures of common classroom objects to use with the Mixed-Up Monster activity.
- Prepare papers with stars at the starting point and dots for the ending point to help students draw lines.

Lesson 4: Blending

Prerequisite Foundational Skills



Primary Focus

Students will blend syllables and sounds to form words by using large motor

✦ gestures and/or visual supports. **TEKS K.2.A.v; TEKS K.2.A.viii**

Students will listen to one-syllable words and begin to discern initial

✦ sounds. **TEKS K.2.A.x**

WARM-UP (5 MIN.)

Sound Blending

- Stand in front of the class so students can mirror your actions.
- Hold your left arm in front of your body.
- Say the word *one* as you touch your left shoulder with your right hand (see illustration 1).
- Say the word *two* as you touch your left elbow with your right hand (see illustration 2).
- Say the word *three* as you touch your left wrist with your right hand (see illustration 3).
- Say the word *blend* as you slide your right hand from your left shoulder down to your left wrist (see illustration 4).

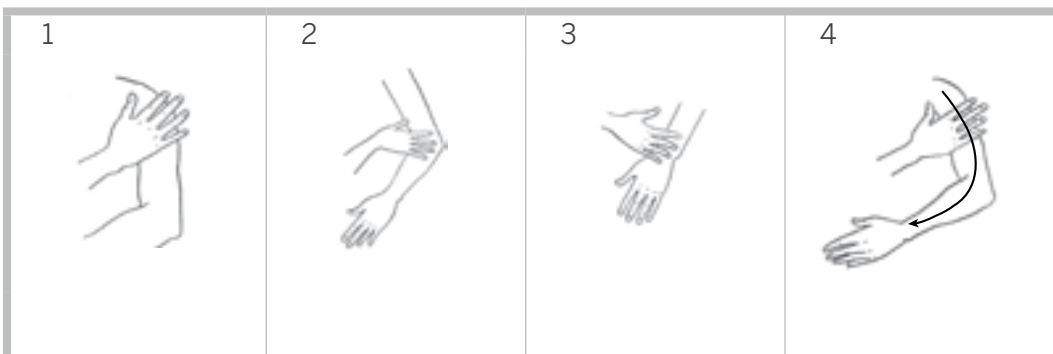

✦ **TEKS K.2.A** Demonstrate phonological awareness by: (v) blending syllables to form multisyllabic words; (viii) blending spoken phonemes to form one-syllable words; (x) segmenting spoken one-syllable words into individual phonemes.

- Practice this with students.
- Tell the class the word *fun* has three sounds. Say the sounds in a segmented fashion: /f/ ... /u/ ... /n/.
- Say the sound /f/ as you touch your left shoulder with your right hand.
- Say the sound /u/ as you touch your left elbow with your right hand.
- Say the sound /n/ as you touch your left wrist with your right hand.
- Say the word *fun* as you slide your right hand from your left shoulder down to your left wrist.
- Practice this with students.
- Complete the remaining words.

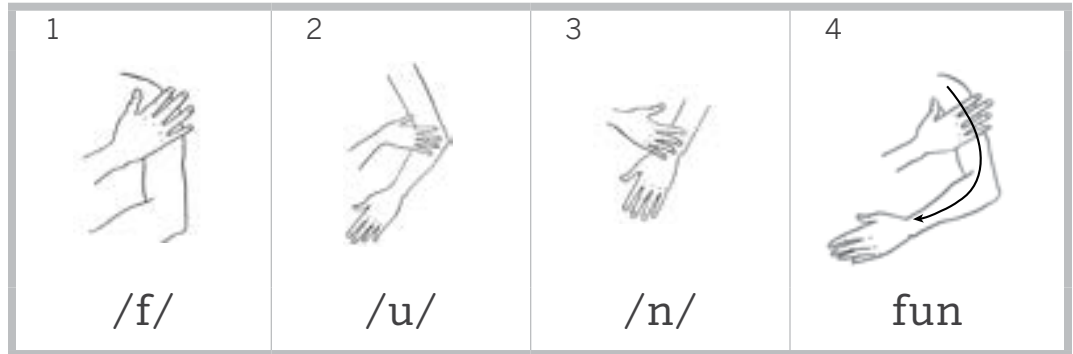

1. /f/ ... /u/ ... /n/ > fun	4. /s/ ... /ie/ ... /n/ > sign
2. /m/ ... /e/ ... /s/ > mess	5. /m/ ... /ee/ ... /n/ > mean
3. /f/ ... /i/ ... /sh/ > fish	6. /z/ ... /oo/ ... /m/ > zoom



Observation: Oral Blending Observation Record

As you listen to students blend the sounds, make notes regarding their individual blending ability in the Oral Blending Observation Record.

PRACTICE BLENDING (10 MIN.)

Picture Card Blending

- Using the Blending Picture Cards you prepared in advance, show the first picture to students and say, “This is a fish.”
- Tell students the word *fish* contains three sounds.
- Say /f/ as you touch your shoulder.
- Say /i/ as you touch your elbow.
- Say /sh/ as you touch your wrist.
- Say *fish* as you sweep your hand down your arm.
- Have students do the same.
- Place the picture of the five next to the picture of the fish. Repeat the procedures outlined above with the word *five*.
- Displaying both pictures, ask students to identify the picture of the /f/ ... /ie/ ... /v/. (Say the word in a segmented fashion, with a one-second pause between the sounds.)
- Ask students to identify the picture of the /f/ ... /i/ ... /sh/.
- Remove the pictures of the fish and the five and repeat the previous procedure with the next two pictures (*rose* and *moon*).
- Display all four pictures and ask the class to find one of them, saying the word in a segmented fashion. Repeat until all four pictures have been identified.

LISTENING FOR BEGINNING SOUNDS (10 MIN.)

Mixed-Up Monster

Note: This exercise allows students to practice listening for the beginning sound in a word. You will need to provide a puppet for this exercise.

- Point to different objects in your classroom and have students identify them.

Note: Instead of using classroom objects, you can also do this exercise with the Blending Picture Cards.

- Introduce the class to the puppet, the Mixed-Up Monster. Tell students he is a friendly monster. Sometimes he needs help pronouncing words correctly.

Blending Picture Cards



Support

Look for other opportunities during the school day to segment words students can then blend (e.g., when calling on Ben, ask for /b/ ... /e/ ... /n/; when it is time for gym, say it is time for /j/ ... /i/ ... /m/).



Foundational Skills

Foundational Literacy Skills

For additional practice, provide pictures of the classroom objects used during the lesson so students, individually or in pairs, can practice at different parts of the day.

ELPS 4.F

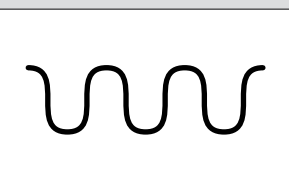

Support

If students have trouble drawing wavy lines, you may draw stars on the paper to indicate where they should start each wavy line and dots to indicate where they should stop.

- Have the Mixed-Up Monster point to one of the objects and incorrectly identify it by mixing up the first sound (e.g., “That’s a feskl!” for *desk*).
- Ask students whether or not the Mixed-Up Monster pronounced the name of the object correctly. Have them correct the Mixed-Up Monster.

Note: Remember to use the sound, not the letter name.

- Have the monster pronounce the names of other objects correctly and incorrectly. As you discuss the objects, talk about the initial sounds and the mistakes the monster makes (e.g., “The monster said /f/ instead of /d/”).

Lesson 4: Prewriting

Prerequisite Writing Skills



Primary Focus

Students will hold a writing utensil with a tripod (or pincer) grip and draw wavy lines. **Prerequisite Skill**



Students will use spatial words, such as *top*, *bottom*, *left*, *right*, and *middle*, while practicing handwriting. **TEKS K.3.C**



Students will demonstrate understanding of directionality by recognizing the beginning and end of a row. **TEKS K.2.D.ii**



DRAW WAVY LINES ON A VERTICAL SURFACE (10 MIN.)

- Tape multiple pieces of chart paper to the wall at a height students can reach.
- Review the position words *top*, *bottom*, *left*, *right*, and *middle* with students, pointing out the top, bottom, left side, right side, and middle of one of the pieces of chart paper.
- Give each student a crayon.
- Draw a wavy line on the board/chart paper. Explain to students a wavy line is made by alternating between cups and humps without picking up the crayon.
- Invite students to trace wavy lines on their desks or in the air with their fingers.
- Have students draw wavy lines on the chart paper.
- Circulate the room, correcting grips and assisting students as they draw wavy lines.



TEKS K.3.C Identify and use words that name actions; directions; positions; sequences; categories such as colors, shapes, and textures; and locations; **TEKS K.2.D.ii** Demonstrate print awareness by holding a book right side up, turning pages correctly, and knowing that reading moves from top to bottom and left to right with return sweep.

WAVY LINE PRACTICE (15 MIN.)

- Have students settle into the proper writing posture.

➤ Digital Component 4.1

- Distribute and display Activity Page 4.1.
- Explain that the activity page shows animals and their homes.
- Tell students you are going to draw a line from each animal to its home. They should do the same on their activity pages.
- Show students how to trace the dotted lines. As you draw, explain how you are connecting each animal to its home by drawing a wavy line, starting at the star.
- Provide guided practice by continuing to demonstrate until students are able to work independently.
- Tell students that once they have finished the front of the activity page, they should then complete the back of the activity page.
- Students may color the pictures and/or draw a picture containing at least one wavy line, if time permits.



Activity Page 4.1: Wavy Line Practice

Collect Activity Page 4.1 to review and monitor students' ability to draw a wavy line.

Activity Page 4.1



LEFT-TO-RIGHT DIRECTIONALITY (10 MIN.)

TEKS K.3.C

Beginning/End Recognition

Note: This activity reinforces the terms *beginning* and *end*, which are crucial for tracking from left to right.

➤ Digital Component 4.2

- Distribute and display Activity Page 4.2.
- Explain that there are three items in each row. The item at the beginning of each row needs to be colored green, and the item at the end of each row needs to be colored red.
- Point to the first item in the first row, and tell students it is at the beginning of the row.

Activity Page 4.2



TEKS K.3.C Identify and use words that name actions; directions; positions; sequences; categories such as colors, shapes, and textures; and locations.

- Have students color the item green and repeat *beginning*.
- Point to the last item in the first row, and tell students it is at the end of the row.
- Have students color the item red and repeat *end*.
- Provide guided practice by continuing to demonstrate until students are ready to work independently.
- Circulate the room, correcting grips and assisting students.

End Lesson

Take-Home Material

TRACE SHAPES

- Have students give Activity Page 4.3 to a family member.

Activity Page 4.3



Lesson 4: Prerequisite Foundational Skills Remediation

Additional Support

MORE HELP WITH BLENDING SYLLABLES

Compound Word Pictures

- Make one copy of **Activity Pages TR 1.1 and TR 4.1** for each student.
- Follow the procedure outlined in Lesson 1.
- Possible compound words include:

- | | |
|---------------|-------------|
| 1. lady•bug | 3. cow•boy |
| 2. jelly•fish | 4. rain•bow |

MORE HELP WITH ORAL BLENDING

Find My Word

- Make one copy of **Activity Page TR 4.2** for each student.
- Review the names of the depicted items with students (*head, nose, mouth, ear, chin, knee, foot, leg, and thumb.*) Ask if students can identify the category for the page. (*body parts*)
- Pronounce the names of the body parts by saying the phonemes with a pause in between (e.g., /h/ [pause] /e/ [pause] /d/).
- Follow the procedure outlined in Lesson 3.
- **Option:** Manipulatives can be used to cover pictures as they are identified.
- **Variation:** Students can independently practice segmenting phonemes in the names of the objects shown on the page. It is recommended that you ask students to identify phonemes for the objects from left to right and top to bottom to reinforce their understanding of directionality for tracking.

5

PREREQUISITE SKILLS

Blending and Prewriting

PRIMARY FOCUS OF LESSON

Prerequisite Foundational Skills

Students will blend sounds to form words by using large motor gestures and/or

- ✦ visual supports. **TEKS K.2.A.viii**
- ✦ Students will manipulate syllables within multisyllabic words. **TEKS K.2.A.ix**
- Students will recognize and isolate the initial sounds in classmates' names.
- ✦ **TEKS K.2.A.x**

Prerequisite Writing Skills

Students will hold a writing utensil with a tripod (or pincer) grip and draw spirals.

- ✦ **Prerequisite Skill**
- ✦ Students will recognize and trace their own names. **Prerequisite Skill**
- Students will use spatial words, such as *top*, *bottom*, *left*, *right*, and *middle*, while
- ✦ practicing handwriting. **TEKS K.3.C**

FORMATIVE ASSESSMENT

Observation

Oral Blending Observation Record

- ✦ **TEKS K.2.A.viii**

Activity Page 5.1

Spiral Practice

- ✦ **Prerequisite Skill**

- ✦ **TEKS K.2.A** Demonstrate phonological awareness by: (viii) blending spoken phonemes to form one-syllable words; (ix) manipulating syllables within a multisyllabic word; (x) segmenting spoken one-syllable words into individual phonemes; **TEKS K.3.C** Identify and use words that name actions; directions; positions; sequences; categories such as colors, shapes, and textures; and locations.

LESSON AT A GLANCE

	Grouping	Time	Materials
Prerequisite Foundational Skills			
Warm-Up: Sound Blending (Phonological Awareness)	Whole Group	5 min.	
Practice Blending: Picture Card Blending (Phonological Awareness)	Whole Group	10 min.	<input type="checkbox"/> Blending Picture Cards for <i>shell</i> , <i>mice</i> , <i>fan</i> , and <i>wave</i>
Listening for Beginning Sounds: If Your Name Starts With . . . (Phonological Awareness)	Whole Group	10 min.	
Prerequisite Writing Skills			
Draw Spirals on a Vertical Surface	Whole Group/ Independent	10 min.	<input type="checkbox"/> crayons <input type="checkbox"/> chart paper
Spiral Practice	Whole Group/ Independent	15 min.	<input type="checkbox"/> Activity Page 5.1 <input type="checkbox"/> Activity Page 5.1 (Digital Components)
Name Tracing	Whole Group/ Independent	10 min.	<input type="checkbox"/> crayons or dry-erase marker <input type="checkbox"/> tracing paper or sheet protector <input type="checkbox"/> name cards
Take-Home Material			
Trace Shapes			<input type="checkbox"/> Activity Page 5.2

ADVANCE PREPARATION

Prerequisite Foundational Skills

- Gather the Blending Picture Cards for *shell*, *mice*, *fan*, and *wave*.
- Make a list of students' names organized by the first sound of each name (e.g., /k/: Ken, Chris, Caleb; /m/: Mike, Meg, Mitch) for the Listening for Beginning Sounds activity.

Prerequisite Writing Skills

- Provide crayons for students to use and tape multiple pieces of chart paper to the wall at a height that students can reach for the Draw Spirals on a Vertical Surface activity.

➤ Digital Component 5.1

- Create an enlarged version of Activity Page 5.1 to display for Spiral Practice, or use the digital version (Digital Component 5.1).
- Write each student's name on a card, capitalizing the first letter and writing the remaining letters in lowercase. Affix the name cards on the students' desks to be used for the Name Tracing activity.
- Provide each student with a sheet of tracing paper or plastic sheet protector. If you use the sheet protector, grease pencils or dry-erase markers will work best.

Universal Access

- Bring in pictures of the following words: *mat*, *wish*, *neat*, *fight*, *sit*, *zip*, *sun*, and *meet* for the Warm-Up activity.
- Prepare papers with stars at the starting point and dots for the ending point to help students draw lines.

Lesson 5: Blending

Prerequisite Foundational Skills



Primary Focus

Students will blend sounds to form words by using large motor gestures and/or

visual supports. **TEKS K.2.A.viii**

Students will manipulate syllables within multisyllabic words. **TEKS K.2.A.ix**

Students will recognize and isolate the initial sounds in classmates' names.

TEKS K.2.A.x

WARM-UP (5 MIN.)

Sound Blending

- Remind students the word *mat* has three sounds. Say the sounds in a segmented fashion: /m/ ... /a/ ... /t/.
- Stand in front of the class so students can mirror your actions.
- Say the sound /m/ as you touch your left shoulder with your right hand.
- Say the sound /a/ as you touch your left elbow with your right hand.
- Say the sound /t/ as you touch your left wrist with your right hand.
- Say the word *mat* as you slide your right hand from your left shoulder down to your left wrist.

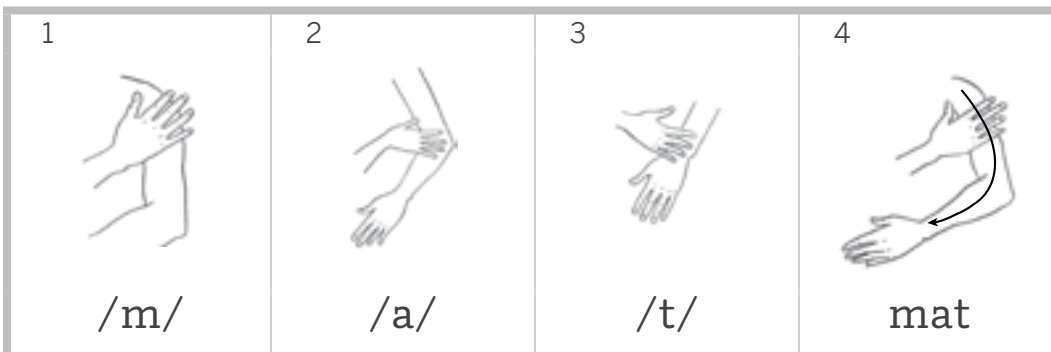

- Practice this with students.
- Complete the list of remaining words.

TEKS K.2.A Demonstrate phonological awareness by: (viii) blending spoken phonemes to form one-syllable words; (ix) manipulating syllables within a multisyllabic word; (x) segmenting spoken one-syllable words into individual phonemes.



**ENGLISH
LANGUAGE
LEARNERS**

Foundational Skills

Foundational Literacy Skills

When introducing the stimulus words, show pictures of the following words: *mat*, *wish*, *neat*, *fight*, *sit*, *zip*, *sun*, and *meet*.

ELPS 4.F

- | | |
|---------------------------------|--------------------------------|
| 1. /m/ ... /a/ ... /t/ > mat | 5. /s/ ... /i/ ... /t/ > sit |
| 2. /w/ ... /i/ ... /sh/ > wish | 6. /z/ ... /i/ ... /p/ > zip |
| 3. /n/ ... /ee/ ... /t/ > neat | 7. /s/ ... /u/ ... /n/ > sun |
| 4. /f/ ... /ie/ ... /t/ > fight | 8. /m/ ... /ee/ ... /t/ > meet |

PRACTICE BLENDING (10 MIN.)

Picture Card Blending

- Using the Blending Picture Cards you prepared in advance, show the first picture to students and say, "This is a shell."
- Tell the class the word *shell* contains three sounds.
- Say /sh/ as you touch your shoulder.
- Say /e/ as you touch your elbow.
- Say /l/ as you touch your wrist.
- Have students do the same.
- Place the picture of the mice next to the picture of the shell. Repeat the procedures outlined above with the word *mice*.
- Displaying both pictures, ask students to identify the picture of the /sh/ ... /e/ ... /l/. (Say the word in a segmented fashion, with a one-second pause between the sounds.)
- Ask students to identify the picture of the /m/ ... /ie/ ... /s/.
- Remove the pictures of the shell and the mice and repeat the same procedures with the next two pictures (*fan*, *wave*).
- Display all four pictures and ask students to find one of them, saying the word in a segmented fashion. Repeat until all four pictures have been identified.

Blending Picture Cards



Support

Look for other opportunities during the school day to segment words students can then blend, (e.g., when calling on Ben, ask for /b/ ... /e/ ... /n/; when it is time for gym, say it is time for /j/ ... /i/ ... /m/).

Challenge

Add more cards if students appear ready.



Observation: Oral Blending Observation Record

As you listen to students blend the sounds, make notes regarding their individual blending ability in the Oral Blending Observation Record.

LISTENING FOR BEGINNING SOUNDS (10 MIN.)

If Your Name Starts With . . .

- As a class, review the first sound in each of the students' names.
- Sing the following verses to the tune of "If You're Happy and You Know It."

If your name starts with (sound), clap your hands.

If your name starts with (sound), clap your hands.

If your name starts with (sound), then you surely want to show it.

If your name starts with (sound), clap your hands.

- Be sure to say sounds, not letter names.
- Continue until each student has had a chance to respond or until the game is no longer useful.

Challenge

Changing "clap your hands" to a different action will hold students' attention longer (e.g., stand up, wink your eye, touch your nose, touch your toes, or stomp your feet).

Lesson 5: Prewriting

Prerequisite Writing Skills



Primary Focus

Students will hold a writing utensil with a tripod (or pincer) grip and draw

✦ spirals. **Prerequisite Skill**

✦ Students will recognize and trace their own names. **Prerequisite Skill**

Students will use spatial words, such as *top*, *bottom*, *left*, *right*, and *middle*, while

✦ practicing handwriting. **TEKS K.3.C**

DRAW SPIRALS ON A VERTICAL SURFACE (10 MIN.)

- Review the position words *top*, *bottom*, *left*, *right*, and *middle* with students, pointing out the top, bottom, left side, right side, and middle of one of the pieces of chart paper.
- Draw a spiral on the board/chart paper starting from the inside of the spiral. Explain that a spiral starts out like a circle but then curls around outside, getting larger as it goes.
- Invite students to trace spirals on their desks or in the air with their fingers.
- Have students draw spirals on the chart paper.
- Circulate, correcting grips and assisting students as they draw spirals.

SPIRAL PRACTICE (15 MIN.)

➤ Digital Component 5.1

- Distribute and display Activity Page 5.1.
- Have students settle into the proper writing posture.
- Explain that the activity page shows some snails, and each snail is missing its shell.

✦ **TEKS K.3.C** Identify and use words that name actions; directions; positions; sequences; categories such as colors, shapes, and textures; and locations.

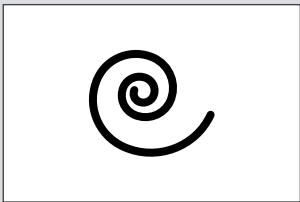

Activity Page 5.1



- Tell students you are going to give each snail a shell, and that they should do the same on their activity pages.
- Show students how to give one of the snails a shell by tracing the dotted spiral. As you draw, explain that you are giving the snail a shell by drawing a spiral, starting at the star.
- Provide guided practice by continuing to demonstrate until students are ready to work independently.
- Tell students that once they have finished the front of the activity page, they should then complete the back of the page.
- Students may color the pictures and/or draw a picture containing at least one spiral, if time permits.



Activity Page 5.1: Spiral Practice

Collect Activity Page 5.1 to review and monitor students' ability to draw a spiral.

NAME TRACING (10 MIN.)

Note: This exercise will help students begin to recognize and write their names.

- Provide each student with a sheet of tracing paper or plastic sheet protector. If you use the sheet protector, grease pencils or dry-erase markers will work best.
- Have each student trace his or her name several times using the affixed name card.

Note: You may use various methods to teach students to write their names, including, but not limited to, sand writing, air writing, finger tracing, and clay modeling.

Take-Home Material

TRACING SHAPES

Activity Page 5.2



- Have students give Activity Page 5.2 to a family member.

Lesson 5: Prerequisite Foundational Skills Remediation

Additional Support

MORE HELP WITH BLENDING SYLLABLES

✦ Silly Monster **TEKS K.2.A.ix**

- Make one copy of **Activity Page TR 5.1** for each student.
- Name the objects Silly Monster sees by saying the syllables with a pause in between (e.g., po [pause] ny).
- Have students echo you by blending the syllables orally.
- Once students are comfortable, have them blend the words using a silly monster voice.
- Possible words include:

1. mop•ping	5. buck•et	9. mom•my	13. spil•ling
2. a•pron	6. glass•es	10. sneak•ers	14. slip•ping
3. mon•ey	7. drop•ping	11. push•ing	15. walk•ing
4. pay•ing	8. ba•by	12. sit•ting	16. stand•ing

MORE HELP WITH ORAL BLENDING

Find My Word

- Make one copy of **Activity Page TR 5.2** for each student.
- Follow the procedure for Find My Word in Lesson 3.

✦ **TEKS K.2.A.ix** Demonstrate phonological awareness by manipulating syllables within a multisyllabic word.

PREREQUISITE SKILLS

Blending and Prewriting

PRIMARY FOCUS OF LESSON

Prerequisite Foundational Skills

Students will blend sounds to form words by using large motor gestures and/or visual supports. **TEKS K.2.A.viii**

Students will recognize and isolate the initial sounds in classmates' names.

TEKS K.2.A.x

Prerequisite Writing Skills

Students will hold a writing utensil with a tripod (or pincer) grip and draw + and x. **Prerequisite Skill**

Students will recognize and trace their own names. **Prerequisite Skill**

Students will use spatial words, such as *top*, *bottom*, *left*, *right*, and *middle*, while practicing handwriting. **TEKS K.3.C**

FORMATIVE ASSESSMENT

Observation

Oral Blending Observation Record

TEKS K.2.A.viii

Activity Page 6.1

+ and × Practice

Prerequisite Skill

TEKS K.2.A Demonstrate phonological awareness by: (viii) blending spoken phonemes to form one-syllable words; (x) segmenting spoken one-syllable words into individual phonemes; **TEKS K.3.C** Identify and use words that name actions; directions; positions; sequences; categories such as colors, shapes, and textures; and locations.

LESSON AT A GLANCE

	Grouping	Time	Materials
Prerequisite Foundational Skills			
Warm-Up: Sound Blending (Phonological Awareness)	Whole Group	5 min.	
Practice Blending: Picture Card Blending (Phonological Awareness)	Whole Group	10 min.	<input type="checkbox"/> Blending Picture Cards
Listening for Beginning Sounds: Guess Who? (Phonological Awareness)	Whole Group	10 min.	
Prerequisite Writing Skills			
Draw + and × on a Vertical Surface	Whole Group/ Independent	10 min.	<input type="checkbox"/> crayons <input type="checkbox"/> chart paper
+ and × Practice	Whole Group/ Independent	15 min.	<input type="checkbox"/> Activity Page 6.1 <input type="checkbox"/> Activity Page 6.1 (Digital Components)
Name Tracing	Whole Group/ Independent	10 min.	<input type="checkbox"/> crayons or dry-erase marker <input type="checkbox"/> tracing paper or sheet protector <input type="checkbox"/> name cards
Take-Home Material			
+ and × Practice			<input type="checkbox"/> Activity Page 6.2

ADVANCE PREPARATION

Prerequisite Foundational Skills

- Gather eight to ten of the Blending Picture Cards you have used in previous lessons.

Prerequisite Writing Skills

- Provide crayons for students to use and tape multiple pieces of chart paper to the wall at a height that students can reach for the Draw + and × on a Vertical Surface activity.

➤ Digital Component 6.1

- Create an enlarged version of Activity Page 6.1 to display for + and × Practice, or use the digital version (Digital Component 6.1).
- Provide each student with a sheet of tracing paper or plastic sheet protector. If you use the sheet protector, grease pencils or dry-erase markers will work best.

Universal Access

- Bring in pictures of the following words: *mat*, *wish*, *neat*, *fight*, *sit*, *zip*, *sun*, and *meet* for the Warm-Up activity.
- Prepare papers with stars at the starting point and dots for the ending point to help students draw lines.

Lesson 6: Blending

Prerequisite Foundational Skills



Primary Focus





Students will blend sounds to form words by using large motor gestures and/or visual supports. **TEKS K.2.A.viii**

Students will recognize and isolate the initial sounds in classmates' names. **TEKS K.2.A.x**

WARM-UP (5 MIN.)

Sound Blending

- Follow the steps outlined in Lesson 5.

1	2	3	4
			
/m/	/a/	/t/	mat

- | | |
|---------------------------------|--------------------------------|
| 1. /m/ ... /a/ ... /t/ > mat | 5. /s/ ... /i/ ... /t/ > sit |
| 2. /w/ ... /i/ ... /sh/ > wish | 6. /z/ ... /i/ ... /p/ > zip |
| 3. /n/ ... /ee/ ... /t/ > neat | 7. /s/ ... /u/ ... /n/ > sun |
| 4. /f/ ... /ie/ ... /t/ > fight | 8. /m/ ... /ee/ ... /t/ > meet |

ENGLISH
LANGUAGE
LEARNERS



Foundational Skills

Foundational Literacy Skills

When introducing the stimulus words, show pictures of the following: *mat*, *wish*, *neat*, *fight*, *sit*, *zip*, *sun*, and *meet*.

ELPS 4.F

TEKS K.2.A Demonstrate phonological awareness by: (viii) blending spoken phonemes to form one-syllable words; (x) segmenting spoken one-syllable words into individual phonemes.

PRACTICE BLENDING (10 MIN.)

Picture Card Blending

- Display all of the Blending Picture Cards you prepared in advance, and review the names of the pictures with students.
- Say one of the names of the pictures in a segmented fashion and have a student select the correct Picture Card.
- Have the student and/or the entire class segment and blend the word. Make sure students use the arm motions as they segment and blend the word.
- Blend the remaining cards.

LISTENING FOR BEGINNING SOUNDS (10 MIN.)

Guess Who?

- Tell students you are thinking of a person in the classroom. You want students to guess who it is but first you will give them a hint.
- Tell students the first sound of the person's name. Be sure to elongate the sound if it can be stretched out, or repeat the sound several times if it cannot.
- Have students identify the person.
- Repeat with eight or more names.



Observation: Oral Blending Observation Record

As you listen to students blend the sounds, make notes regarding their individual blending ability in the Oral Blending Observation Record.

Support

Reduce the number of Picture Cards as needed.

Blending Picture Cards



Challenge

Once students are familiar with this game, let them take turns thinking of a person.

Lesson 6: Prewriting

Prerequisite Writing Skills



Primary Focus

Students will hold a writing utensil with a tripod (or pincer) grip and draw a +

✦ and an x. **Prerequisite Skill**

✦ Students will recognize and trace their own names. **Prerequisite Skill**

Students will use spatial words, such as *top*, *bottom*, *left*, *right*, and *middle*, while

✦ practicing handwriting. **TEKS K.3.C**

DRAW + AND × ON A VERTICAL SURFACE (10 MIN.)

Note: Drawing + and × multiple times will prepare students to write 't,' 'x,' and other letters.

- Review the position words *top*, *bottom*, *left*, *right*, and *middle* with students, pointing out the top, bottom, left side, right side, and middle of one of the pieces of chart paper.
- Be sure to use the position words while you demonstrate the strokes.
- Draw a vertical line on the board/chart paper and invite students to do the same on chart paper. Tell students to begin at the top and draw the line down.
- Tell students you are going to make a new design, called a plus sign, by adding a horizontal line to the vertical line. Demonstrate and point out how to estimate the middle of the vertical line, so you can draw the horizontal line at that level, starting to the left of the vertical line and ending on the right.
- Have students draw + on the chart paper. Tell students to start on the left and draw across to the right.
- Circulate the room, correcting grips and assisting students. Make sure students are creating a + with vertical and horizontal lines that “stand up straight” and create right angles where the lines intersect.

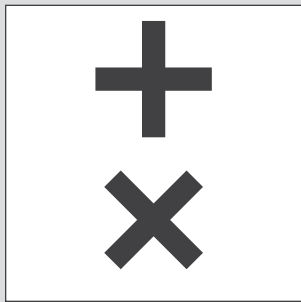

Support

If students have trouble drawing an x, you may draw stars on the paper to indicate where they should start each diagonal line in each x and dots to indicate where they should stop each diagonal line in each x.

✦ **TEKS K.3.C** Identify and use words that name actions; directions; positions; sequences; categories such as colors, shapes, and textures; and locations.

- Now tell students you are going to make another new design called an \times . It also has two lines that cross in the middle like the plus sign, but it looks different because diagonal lines are used to create it. Demonstrate drawing an \times , calling attention to the way the diagonal lines cross at the middle of each line.

Note: The \times will likely be more difficult for students to copy initially as they may experience difficulty in estimating and drawing the angle of each diagonal line so they intersect in the middle.

- Have students draw \times on the chart paper.
- Circulate the room, correcting grips and assisting students.

+ AND \times PRACTICE (15 MIN.)

- Have students settle into the proper writing posture.

> Digital Component 6.1

- Distribute and display Activity Page 6.1.
- Tell students the activity page shows + and \times .
- Tell students you are going to trace each an + and an \times , and they should do the same on their activity page.
- Show students how to trace a +, starting each of the + symbol's vertical and horizontal lines at a star.
- Provide guided practice by continuing to demonstrate until students are ready to work independently. Then repeat the demonstration and practice of \times .
- Tell students that once they have finished the front of the activity page, they should then complete the back of the activity.
- Students may draw a picture containing at least one + or \times , if time permits.

Activity Page 6.1



Activity Page 6.1: + and \times Practice

Collect Activity Page 6.1 to review and monitor students' ability to draw + and \times multiple times.

NAME TRACING (10 MIN.)

- Provide each student with a sheet of tracing paper.
- Have each student trace his or her name several times using the affixed name card.

~~~~~End Lesson~~~~~

# Take-Home Material

---

**+ AND x PRACTICE**

- Have students give Activity Page 6.2 to a family member.

Activity Page 6.2

---



Lesson 6: Prerequisite Foundational Skills Remediation

# Additional Support

## MORE HELP WITH ORAL BLENDING

### Clap and Pat Sounds

**Note:** This exercise allows students to “feel” sounds by clapping and patting them.

- Say *cup*.
- Say the word again in a segmented fashion, clapping once for each sound, (e.g., /k/ clap ... /u/ clap ... /p/ clap).
- Say the blended word, *cup*, as you pat your lap with both hands.
- Repeat with the remainder of the words and have students echo the words and motions.

- |                                |                           |
|--------------------------------|---------------------------|
| 1. cup > /k/ /u/ /p/           | 5. pet > /p/ /e/ /t/      |
| 2. chips > /ch/ /i/ /p/ /s/    | 6. right > /r/ /ie/ /t/   |
| 3. fun > /f/ /u/ /n/           | 7. left > /l/ /e/ /f/ /t/ |
| 4. plant > /p/ /l/ /a/ /n/ /t/ | 8. fish > /f/ /i/ /sh/    |

### Find My Word

- Make one copy of **Activity Page TR 6.1** for each student.
- Follow the procedure for Find My Word in Lesson 3.

## 7

## PREREQUISITE SKILLS

## Blending and Prewriting

## PRIMARY FOCUS OF LESSON

**Prerequisite Foundational Skills**

Students will blend sounds to form words by using large motor gestures and/or

- ✦ visual supports. **TEKS K.2.A.viii**

Students will isolate the initial sounds of common objects by identifying pictures.

- ✦ **TEKS K.2.A.x**

**Prerequisite Writing Skills**

Students will hold a writing utensil with a tripod (or pincer) grip and draw loops.

- ✦ **Prerequisite Skill**

- ✦ Students will recognize and trace their own names. **Prerequisite Skill**

Students will use spatial words, such as *top*, *bottom*, *left*, *right*, and *middle*, while

- ✦ practicing handwriting. **TEKS K.3.C**

## FORMATIVE ASSESSMENT

Observation

Oral Blending Observation Record

- ✦ **TEKS K.2.A.viii**

Activity Page 7.1

Loop Practice

- ✦ **Prerequisite Skill**

- ✦ **TEKS K.2.A** Demonstrate phonological awareness by: (viii) blending spoken phonemes to form one-syllable words; (x) segmenting spoken one-syllable words into individual phonemes; **TEKS K.3.C** Identify and use words that name actions; directions; positions; sequences; categories such as colors, shapes, and textures; and locations.

## LESSON AT A GLANCE

|                                                                                               | Grouping                    | Time    | Materials                                                                                                                                                |
|-----------------------------------------------------------------------------------------------|-----------------------------|---------|----------------------------------------------------------------------------------------------------------------------------------------------------------|
| <b>Prerequisite Foundational Skills</b>                                                       |                             |         |                                                                                                                                                          |
| Warm-Up: Sound Blending<br>(Phonological Awareness)                                           | Whole Group                 | 5 min.  |                                                                                                                                                          |
| Practice Blending:<br>Picture Card Blending<br>(Phonological Awareness)                       | Whole Group                 | 10 min. | <input type="checkbox"/> Blending Picture Cards                                                                                                          |
| Listening for Beginning Sounds:<br>Find Things by Beginning Sound<br>(Phonological Awareness) | Whole Group                 | 10 min. | <input type="checkbox"/> Blending Picture Cards for<br><i>mouth, moon, moth, mice, fish,</i><br><i>five, fan and foot</i>                                |
| <b>Prerequisite Writing Skills</b>                                                            |                             |         |                                                                                                                                                          |
| Draw Loops on a Vertical Surface                                                              | Whole Group/<br>Independent | 10 min. | <input type="checkbox"/> crayons<br><input type="checkbox"/> chart paper                                                                                 |
| Loop Practice                                                                                 | Whole Group/<br>Independent | 15 min. | <input type="checkbox"/> Activity Page 7.1<br><input type="checkbox"/> Activity Page 7.1<br>(Digital Components)                                         |
| Name Tracing                                                                                  | Whole Group/<br>Independent | 10 min. | <input type="checkbox"/> crayons or dry-erase marker<br><input type="checkbox"/> tracing paper or sheet protector<br><input type="checkbox"/> name cards |
| <b>Take-Home Material</b>                                                                     |                             |         |                                                                                                                                                          |
| Trace Shapes                                                                                  |                             |         | <input type="checkbox"/> Activity Page 7.2                                                                                                               |



## ADVANCE PREPARATION

### Prerequisite Foundational Skills

- Gather eight to ten of the Blending Picture Cards you have used in previous lessons for use in the Practice Blending activity.
- Gather the Blending Picture Cards for *mouth*, *moon*, *moth*, *mice*, *fish*, *five*, *fan*, and *foot* for use in the Listening for Beginning Sounds activity.

### Prerequisite Writing Skills

- Provide crayons for students to use and tape multiple pieces of chart paper to the wall at a height that students can reach for the Drawing Loops on a Vertical Surface activity.

### ➤ Digital Component 7.1

- Create an enlarged version of Activity Page 7.1 to display for Loop Practice, or use the digital version (Digital Component 7.1).
- Provide each student with a sheet of tracing paper or plastic sheet protector. If you use the sheet protector, grease pencils or dry-erase markers will work best.

### Universal Access

- Find objects or additional pictures of objects starting with either /m/ or /f/.
- Prepare papers with stars at the starting point and dots at the ending point to help students draw lines.

## Lesson 7: Blending

# Prerequisite Foundational Skills



## Primary Focus

Students will blend sounds to form words by using large motor gestures and/or visual supports. **TEKS K.2.A.viii**





Students will isolate the initial sounds of common objects by identifying pictures.

**TEKS K.2.A.x**

## WARM-UP (5 MIN.)

### Sound Blending

- Follow the steps outlined in Lesson 5.

|                                                                                     |                                                                                     |                                                                                     |                                                                                      |
|-------------------------------------------------------------------------------------|-------------------------------------------------------------------------------------|-------------------------------------------------------------------------------------|--------------------------------------------------------------------------------------|
| 1                                                                                   | 2                                                                                   | 3                                                                                   | 4                                                                                    |
|  |  |  |  |
| /k/                                                                                 | /u/                                                                                 | /p/                                                                                 | cup                                                                                  |

- |                                  |                                 |
|----------------------------------|---------------------------------|
| 1. /k/ ... /u/ ... /p/ > cup     | 5. /s/ ... /ae/ ... /m/ > same  |
| 2. /f/ ... /ee/ ... /t/ > feet   | 6. /n/ ... /ie/ ... /t/ > night |
| 3. /sh/ ... /ee/ ... /p/ > sheep | 7. /k/ ... /a/ ... /t/ > cat    |
| 4. /m/ ... /e/ ... /n/ > men     | 8. /t/ ... /o/ ... /p/ > top    |

**TEKS K.2.A** Demonstrate phonological awareness by: (viii) blending spoken phonemes to form one-syllable words; (x) segmenting spoken one-syllable words into individual phonemes.

## Blending Picture Cards



### Support

Reduce the number of Picture Cards, if needed.

ENGLISH  
LANGUAGE  
LEARNERS



### Foundational Skills

#### Foundational Literacy Skills

Go over the names and pronunciations of the pictures before

**ELPS 4.F**

## PRACTICE BLENDING (10 MIN.)

### Picture Card Blending

- Display the Blending Picture Cards you prepared in advance, and review the names of the pictures with students.
- Say one of the names of the pictures in a segmented fashion and have a student select the correct Picture Card.
- Elicit student responses from individuals as well as the entire group. First have the student, and then the whole class, segment and blend the word. Make sure students use the arm motions as they segment and blend the word.
- Blend the remaining cards.



### Observation: Oral Blending Observation Record

As you listen to students blend the sounds, make notes regarding their individual blending ability in the Oral Blending Observation Record.

## LISTENING FOR BEGINNING SOUNDS (10 MIN.)

### Find Things by Beginning Sound

**Note:** In this exercise students practice listening to beginning sounds in words.

- Using the Blending Picture Cards you prepared in advance. mix up the pictures and place them face up on the floor.
- Review the names of the depicted items with students.
- Ask a student to find a picture of something beginning with either the /m/ sound or the /f/ sound.
- Have the student name the picture.
- Repeat until all pictures have been identified.

**/m/**

1. mouth
2. moon
3. moth
4. mice

**/f/**

1. fish
2. five
3. fan
4. foot

## Challenge

Add objects or additional pictures of objects starting with either of the target sounds.

### Lesson 7: Prewriting

# Prerequisite Writing Skills



## Primary Focus

Students will hold a writing utensil with a tripod (or pincer) grip and draw loops.

### ✦ Prerequisite Skill

✦ Students will recognize and trace their own names. **Prerequisite Skill**

Students will use spatial words, such as *top*, *bottom*, *left*, *right*, and *middle*, while

✦ practicing handwriting. **TEKS K.3.C**

## DRAW LOOPS ON A VERTICAL SURFACE (10 MIN.)

- Review the position words *top*, *bottom*, *left*, *right*, and *middle* with students, pointing out the top, bottom, left side, right side, and middle of one of the pieces of chart paper.
- Draw a loop on the board/chart paper. Tell students a loop is made by drawing a line that goes up, around, and down, crossing itself at the bottom.
- Invite students to trace loops on their desks or in the air with their fingers.
- Have students draw loops on the chart paper.
- Circulate, correcting grips and assisting students as they draw loops.



## Support

If students have trouble drawing loops, you may draw stars on the paper to indicate where they should start each loop and dots to indicate where they should stop.

✦ **TEKS K.3.C** Identify and use words that name actions; directions; positions; sequences; categories such as colors, shapes, and textures; and locations.

## Activity Page 7.1



### LOOP PRACTICE (15 MIN.)

- Have students settle into the proper writing posture.

#### ➤ Digital Component 7.1

- Distribute and display Activity Page 7.1.
- Explain that the activity page shows some bees, and that each bee needs to get to its hive.
- Tell students you are going to add a path for each bee. They should do the same on their activity page.
- Show students how to add a path for each bee by tracing the dotted line. As you draw, explain that you are adding a path for the bee by drawing a series of loops, starting at the star.
- Provide guided practice by continuing to demonstrate until students are ready to work independently.
- Tell students that once they have finished the front of the activity page, they should then complete the back of the page.
- If students finish early, they may color the pictures and/or draw a picture containing at least one loop.



#### Activity Page 7.1: Loop Practice

Collect Activity Page 7.1 to review and monitor students' ability to draw loops.

### Challenge

Have each student glue pictures of items beginning with the same sound as their name on the tracing paper, or have each student draw pictures of items beginning with the same sound as their name on the tracing paper.

### NAME TRACING (10 MIN.)

- Have each student trace their name using the affixed name card.
- Instruct each student to write the first letter of their name below the tracing and then trace the rest of their name.
- Have students repeat this process until they have filled up the rest of the page.

# Take-Home Material

## TRACE SHAPES

- Have students give Activity Page 7.2 to a family member.

Activity Page 7.2



## Lesson 7: Prerequisite Foundational Skills Remediation

# Additional Support

## MORE HELP WITH ORAL BLENDING

### Clap and Pat Sounds

**Note:** This exercise allows students to “feel” sounds as they blend them.

- Follow the procedure for Clap and Pat Sounds in Lesson 6.

- |                           |                              |
|---------------------------|------------------------------|
| 1. cow > /k/ /ou/         | 6. sheep > /sh/ /ee/ /p/     |
| 2. frog > /f/ /r/ /o/ /g/ | 7. bird > /b/ /e/ /r/ /d/    |
| 3. dog > /d/ /o/ /g/      | 8. lamb > /l/ /a/ /m/        |
| 4. duck > /d/ /u/ /k/     | 9. cat > /k/ /a/ /t/         |
| 5. bear > /b/ /ae/ /r/    | 10. chimp > /ch/ /i/ /m/ /p/ |

## MORE HELP WITH WRITING STROKES

### Writing Strokes

- Make one copy of **Activity Page TR 7.1** for each student.
- Have students trace the dotted lines to duplicate targeted strokes.

## 8

## PREREQUISITE SKILLS

## Blending and Prewriting

## PRIMARY FOCUS OF LESSON

**Prerequisite Foundational Skills**

- Students will blend sounds to form words by using large motor gestures and/or visual supports. **TEKS K.2.A.viii**
- Students will isolate the initial sounds of common objects by identifying pictures. **TEKS.K.2.A.x**

**Prerequisite Writing Skills**

- Students will hold a writing utensil with a tripod (or pincer) grip and draw canes. **Prerequisite Skill**
- Students will recognize and trace their own names. **Prerequisite Skill**
- Students will use spatial words that name positions, such as *top*, *bottom*, *left*, *right*, and *middle*, while practicing handwriting. **TEKS K.3.C**

## FORMATIVE ASSESSMENT

Observation

Oral Blending Observation Record

✦ **TEKS K.2.A.viii**

Activity Page 8.1

Cane Practice

✦ **Prerequisite Skill**

- ✦ **TEKS K.2.A** Demonstrate phonological awareness by: (viii) blending spoken phonemes to form one-syllable words; (x) segmenting spoken one-syllable words into individual phonemes; **TEKS K.3.C** Identify and use words that name actions; directions; positions; sequences; categories such as colors, shapes, and textures; and locations.

## LESSON AT A GLANCE

|                                                                                               | Grouping                    | Time    | Materials                                                                                                                                                                     |
|-----------------------------------------------------------------------------------------------|-----------------------------|---------|-------------------------------------------------------------------------------------------------------------------------------------------------------------------------------|
| <b>Prerequisite Foundational Skills</b>                                                       |                             |         |                                                                                                                                                                               |
| Warm-Up: Sound Blending<br>(Phonological Awareness)                                           | Whole Group                 | 5 min.  |                                                                                                                                                                               |
| Practice Blending:<br>Mystery Pictures<br>(Phonological Awareness)                            | Whole Group                 | 10 min. | <input type="checkbox"/> Blending Picture Cards                                                                                                                               |
| Listening for Beginning Sounds:<br>Find Things by Beginning Sound<br>(Phonological Awareness) | Whole Group                 | 10 min. | <input type="checkbox"/> Blending Picture Cards for <i>shell</i> ,<br><i>sheep</i> , <i>ship</i> , <i>shed</i> , <i>knee</i> , <i>nose</i> ,<br><i>knife</i> , and <i>nut</i> |
| <b>Prerequisite Writing Skills</b>                                                            |                             |         |                                                                                                                                                                               |
| Drawing Canes on<br>a Vertical Surface                                                        | Whole Group/<br>Independent | 10 min. | <input type="checkbox"/> crayons<br><input type="checkbox"/> chart paper                                                                                                      |
| Cane Practice                                                                                 | Whole Group/<br>Independent | 15 min. | <input type="checkbox"/> Activity Page 8.1<br><input type="checkbox"/> Activity Page 8.1<br>(Digital Components)                                                              |
| Name Tracing                                                                                  | Whole Group/<br>Independent | 10 min. | <input type="checkbox"/> crayons or dry-erase marker<br><input type="checkbox"/> tracing paper or sheet protector<br><input type="checkbox"/> name cards                      |
| <b>Take-Home Material</b>                                                                     |                             |         |                                                                                                                                                                               |
| Cane Practice                                                                                 |                             |         | <input type="checkbox"/> Activity Page 8.2                                                                                                                                    |



## ADVANCE PREPARATION

### Prerequisite Foundational Skills

- Gather eight to ten of the Blending Picture Cards you have used in previous lessons for Practice Blending.
- Gather the Blending Picture Cards for *shell, sheep, ship, shed, knee, nose, knife,* and *nut* for Listening for Beginning Sounds.

### Prerequisite Writing Skills

- Provide crayons for students to use and tape multiple pieces of chart paper to the wall at a height that students can reach for Drawing Canes on a Vertical Surface.

### ➤ Digital Component 8.1

- Create an enlarged version of Activity Page 8.1 to display for Cane Practice, or use the digital version (Digital Component 8.1).
- Provide each student with a sheet of tracing paper or plastic sheet protector. If you use the sheet protector, grease pencils or dry-erase markers will work best.

### Universal Access

- Gather Picture Cards for *mouth, moon, moth, mice, fish, five, fan,* and *foot* for “Sound Blending.”
- Gather objects or additional pictures that begin with the /sh/ and /n/ sounds.
- Prepare papers with stars at the starting point and dots for the ending point to help students draw lines.
- Gather pictures that begin with the sounds of students’ first names.

## Lesson 8: Blending

# Prerequisite Foundational Skills



## Primary Focus

Students will blend sounds to form words by using large motor gestures and/or

visual supports. **TEKS K.2.A.viii**





Students will isolate the initial sounds of common objects by identifying

pictures. **TEKS K.2.A.x**

## WARM-UP (5 MIN.)

### Sound Blending

- Follow the steps outlined in Lesson 5.

|                                                                                     |                                                                                     |                                                                                     |                                                                                      |
|-------------------------------------------------------------------------------------|-------------------------------------------------------------------------------------|-------------------------------------------------------------------------------------|--------------------------------------------------------------------------------------|
| 1                                                                                   | 2                                                                                   | 3                                                                                   | 4                                                                                    |
|  |  |  |  |
| /m/                                                                                 | /ou/                                                                                | /th/                                                                                | mouth                                                                                |



ENGLISH  
LANGUAGE  
LEARNERS

## Foundational Skills

### Foundational Literacy Skills

When saying the stimulus words, show pictures of the following: *mouth*, *moon*, *moth*, *mice*, *fish*, *five*, *fan*, and *foot*.

**ELPS 4.F**

### /m/:

- /m/ ... /ou/ ... /th/ > mouth
- /m/ ... /oo/ ... /n/ > moon
- /m/ ... /o/ ... /th/ > moth
- /m/ ... /ie/ ... /s/ > mice

### /f/:

- /f/ ... /i/ ... /sh/ > fish
- /f/ ... /ie/ ... /v/ > five
- /f/ ... /a/ ... /n/ > fan
- /f/ ... /oo/ ... /t/ > foot

**TEKS K.2.A** Demonstrate phonological awareness by: (viii) blending spoken phonemes to form one-syllable words; (x) segmenting spoken one-syllable words into individual phonemes.

## PRACTICE BLENDING (10 MIN.)

### Blending Picture Cards



### Support

Illustrate the blending process needed to identify the picture, using the arm gestures if needed.

### Support

Look for other opportunities during the school day to segment words students can then blend. When calling on Ben, ask for /b/ ... /e/ ... /n/. When it is time for gym, say it is time for /j/ ... /i/ ... /m/.

### Mystery Pictures

**Note:** This exercise removes some of the visual scaffolding students have had in previous blending activities. In this exercise the pictures on the cards are not offered as clues to help with the blending but rather as rewards, presented when blending is successful. This exercise strengthens students' blending skills without the use of visual clues.

- Hold the Blending Picture Cards you prepared in advance so students cannot see the pictures.
- Tell students you will say the sounds in a word and you want them to blend the sounds to figure out what is on the card.
- Say the target word in a segmented fashion (e.g., /m/ ... /ou/ ... /th/).
- When a student answers correctly, reveal the card.
- Repeat with additional Blending Picture Cards.

## LISTENING FOR BEGINNING SOUNDS (10 MIN.)

### Find Things by Beginning Sound

**Note:** In this exercise students practice listening to beginning sounds in words.

- Using the Blending Picture Cards you prepared in advance, mix up the pictures and place them face up on the floor.
- Review the names of the depicted items with students.
- Ask a student to find a picture of something beginning with either the /sh/ sound or the /n/ sound.

### /sh/:

1. shell
2. sheep
3. ship
4. shed

### /n/:

1. knee
2. nose
3. knife
4. nut

- Have the student name the picture.
- Repeat until all of the pictures have been identified.



### Observation: Oral Blending Observation Record

As you listen to students blend the sounds, make notes regarding their individual blending ability in the Oral Blending Observation Record.

### Challenge

Add objects or additional pictures of objects starting with either of the target sounds.

## Lesson 8: Prewriting

# Prerequisite Writing Skills



### Primary Focus

✦ Students will hold a writing utensil with a tripod (or pincer) grip and draw canes. **Prerequisite Skill**

✦ Students will recognize and trace their own names. **Prerequisite Skill**

✦ Students will use spatial words that name positions, such as *top*, *bottom*, *left*, *right*, and *middle*, while practicing handwriting. **TEKS K.3.C**

✦ **DRAW CANES ON A VERTICAL SURFACE (10 MIN.)** **TEKS K.3.C**

**Note:** The cane shape is similar to the stroke used in the letter 'f'.

- Review the position words *top*, *bottom*, *left*, *right*, and *middle* with students, pointing out the top, bottom, left side, right side, and middle of one of the pieces of chart paper.

✦ **TEKS K.3.C** Identify and use words that name actions; directions; positions; sequences; categories such as colors, shapes, and textures; and locations.



### Support

If students have trouble drawing canes, you may draw stars on the paper to indicate where they should start each cane and dots to indicate where they should stop each cane.

- Draw a cane on the board/chart paper. Tell students a cane is made by drawing a small hump and continuing with a vertical line down. Point out that a cane looks a lot like a candy cane or a walking cane.
- Invite students to trace canes on their desks or in the air with their fingers.
- Have students draw canes on the chart paper.
- Circulate, correcting grips and assisting students as they draw canes.

### CANE PRACTICE (15 MIN.)

- Have students settle into the proper writing posture.

#### ➤ Digital Component 8.1

- Distribute and display Activity Page 8.1.
- Tell students the activity page shows a box of candy canes, but some of the candy canes are missing.
- Tell students you are going to add the missing candy canes. They should do the same on their activity pages.
- Show students how to add candy canes to the box by tracing the dotted lines. As you draw, tell students you are adding candy canes to the box by drawing canes, starting at the stars.
- Provide guided practice by continuing to demonstrate until students are ready to work independently.
- Once students have finished the front of the activity page, they should then complete the back of the activity page.
- Students may color the pictures and/or draw a picture containing at least one cane if time permits.

#### Activity Page 8.1



#### Activity Page 8.1: Cane Practice

Collect Activity Page 8.1 to review and monitor students' ability to draw canes.

## NAME TRACING (10 MIN.)

- Have each student trace their name using the affixed name card.
- Instruct each student to write the first two letters of their name below the tracing and then trace the rest of their name.
- Have students repeat this process until they have filled up the rest of the page.

End Lesson

# Take-Home Material

## CANE PRACTICE

- Have students give Activity Page 8.2 to a family member.

### Lesson 8: Prerequisite Foundational Skills Remediation

# Additional Support

## MORE HELP WITH LISTENING FOR BEGINNING SOUNDS

### Give Me a Word

- Gather a collection of any **variety of blocks** (e.g., unit blocks or locking cubes).
- Tell students you will provide a sound and would like for them to say a word that starts with that sound (e.g., “Give me a word that starts with /s/.”).
  - If students struggle to think of a word, prompt them to look around the room for objects that start with the target sound.
- As students provide words that start with the target phoneme, give them a block. With each block students get a turn to place it, building a collective structure as the game continues.
- **Variation:** Challenge students by restricting the game to specific categories such as names of animals or foods.

## Challenge

Have each student glue pictures of items beginning with the same sound as their name to the tracing paper. Alternatively, have each student draw pictures of items beginning with the same sound as their name on the tracing paper.

## Activity Page 8.2



---

## MORE HELP WITH WRITING STROKES

### Decorate the Socks

- Make one copy of **Activity Page TR 8.1** for each student.
- Model any single targeted writing stroke or combination of writing strokes on the board/chart paper for students.
- Have students practice using the writing strokes to decorate the socks on the activity page.

## PREREQUISITE SKILLS

# Blending and Prewriting

## PRIMARY FOCUS OF LESSON

**Prerequisite Foundational Skills**

Students will blend sounds to form words by using large motor gestures and will

- ✦ blend sounds to form words that represent hidden pictures. **TEKS K.2.A.viii**

Students will add a phoneme to the end of each one-syllable word spoken and will

- ✦ blend to create a new word. **TEKS K.2.A.viii**

**Prerequisite Writing Skills**

Students will hold a writing utensil with a tripod (or pincer) grip and draw hooks.

- ✦ **Prerequisite Skill**

- ✦ Students will recognize and trace their own names. **Prerequisite Skill**

Students will use spatial words, such as *top*, *bottom*, *left*, *right*, and *middle*, while

- ✦ practicing handwriting. **TEKS K.3.C**

## FORMATIVE ASSESSMENT

Observation

Oral Blending Observation Record

- ✦ **TEKS K.2.A.viii**

Activity Page 9.1

Hook Practice

- ✦ **Prerequisite Skill**

- ✦ **TEKS K.2.A.viii** Demonstrate phonological awareness by blending spoken phonemes to form one-syllable words;
- ✦ **TEKS K.3.C** Identify and use words that name actions; directions; positions; sequences; categories such as colors, shapes, and textures; and locations.



## LESSON AT A GLANCE

|                                                                                       | Grouping                    | Time    | Materials                                                                                                                                                |
|---------------------------------------------------------------------------------------|-----------------------------|---------|----------------------------------------------------------------------------------------------------------------------------------------------------------|
| <b>Prerequisite Foundational Skills</b>                                               |                             |         |                                                                                                                                                          |
| Warm-Up: Sound Blending<br>(Phonological Awareness)                                   | Whole Group                 | 5 min.  |                                                                                                                                                          |
| Practice Blending:<br>- Mystery Pictures<br>- Add a Sound<br>(Phonological Awareness) | Whole Group                 | 20 min. | <input type="checkbox"/> Blending Picture Cards                                                                                                          |
| <b>Prerequisite Writing Skills</b>                                                    |                             |         |                                                                                                                                                          |
| Draw Hooks on a Vertical Surface                                                      | Whole Group/<br>Independent | 10 min. | <input type="checkbox"/> crayons<br><input type="checkbox"/> chart paper                                                                                 |
| Hook Practice                                                                         | Whole Group/<br>Independent | 15 min. | <input type="checkbox"/> Activity Page 9.1<br><input type="checkbox"/> Activity Page 9.1<br>(Digital Components)                                         |
| Name Tracing                                                                          | Whole Group/<br>Independent | 10 min. | <input type="checkbox"/> crayons or dry-erase marker<br><input type="checkbox"/> tracing paper or sheet protector<br><input type="checkbox"/> name cards |
| <b>Take-Home Material</b>                                                             |                             |         |                                                                                                                                                          |
| Hook Practice                                                                         |                             |         | <input type="checkbox"/> Activity Page 9.2                                                                                                               |

## ADVANCE PREPARATION

### Prerequisite Foundational Skills

- Gather several of the Blending Picture Cards you have used in previous lessons.

### Prerequisite Writing Skills

- Provide crayons for students to use and tape multiple pieces of chart paper to the wall at a height that students can reach for the Drawing Hooks on a Vertical Surface activity.

### ➤ Digital Component 9.1

- Create an enlarged version of Activity Page 9.1 to display for Hook Practice, or use the digital version (Digital Component 9.1).
- Provide each student with a sheet of tracing paper or plastic sheet protector. If you use the sheet protector, grease pencils or dry-erase markers will work best.

### Universal Access

- Bring in pictures to represent words used in the Adding a Sound activity, including *life, lime, line, lies, light, safe, same, save, sail, and sane*.
- Prepare papers with stars at the starting point and dots for the ending point to help students draw lines.
- Gather pictures that begin with the sounds of students' first names and provide glue.

## Lesson 9: Blending

# Prerequisite Foundational Skills

**Primary Focus**

Students will blend sounds to form words by using large motor gestures and will

- blend sounds to form words that represent hidden pictures. **TEKS K.2.A.viii**

Students will add a phoneme to the end of each one-syllable word spoken and will

- blend to create a new word. **TEKS K.2.A.viii**

**WARM-UP (5 MIN.)****Sound Blending**

- Follow the steps outlined in Lesson 5.

|     |     |     |      |
|-----|-----|-----|------|
| 1   | 2   | 3   | 4    |
|     |     |     |      |
| /k/ | /i/ | /s/ | kiss |

- |                                  |                                |
|----------------------------------|--------------------------------|
| 1. /k/ ... /i/ ... /s/ > kiss    | 5. /k/ ... /oe/ ... /t/ > coat |
| 2. /s/ ... /i/ ... /p/ > sip     | 6. /n/ ... /u/ ... /t/ > nut   |
| 3. /sh/ ... /ae/ ... /p/ > shape | 7. /z/ ... /oo/ ... /m/ > zoom |
| 4. /t/ ... /o/ ... /m/ > Tom     | 8. /l/ ... /ie/ ... /k/ > like |

- TEKS K.2.A.viii** Demonstrate phonological awareness by blending spoken phonemes to form one-syllable words.

## PRACTICE BLENDING (20 MIN.)

### Mystery Pictures

- Hold the Blending Picture Cards you prepared in advance so students cannot see the pictures.
- Tell students you will say the sounds in a word and you want them to blend the sounds to identify the picture on the card.
- Say the target word in a segmented fashion (e.g., /m/ ... /ou/ ... /th/).
- When a student answers correctly, reveal the card.
- Repeat with additional Blending Picture Cards.
- **Variation:** If students are able to blend successfully and identify pictures they have seen previously, you may begin to introduce cards they have not seen before.



### Observation: Oral Blending Observation Record

As you listen to students blend the sounds, make notes regarding their individual blending ability in the Oral Blending Observation Record.

### Add a Sound

**Note:** In this exercise students will learn to add a sound to the end of a word to make a new word. This will strengthen their blending skills.

- Explain that a sound can be added to a word to make a new word.
- Say *lie*. Have students repeat the word.
- Ask students to name the word you would make by adding the /f/ sound to the end of *lie*. (*life*)

## Blending Picture Cards



## Support

Illustrate the blending process needed to identify the picture, using the arm gestures if needed.



ENGLISH  
LANGUAGE  
LEARNERS

## Foundational Skills

### Foundational Literacy Skills

When saying the stimulus words, show pictures of the following words: *life, lime, line, lies, light, safe, same, save, sail, and sane*.

**ELPS 4.F**

## Challenge

Once students have said the new word, invite them to discuss its meaning or use it in a sentence.

- If students are unable to answer, say the word in a segmented fashion: *lie* . . . /f/.
- Repeat with the remaining words.

- |                            |                            |
|----------------------------|----------------------------|
| 1. lie > life (/f/ added)  | 6. say > safe (/f/ added)  |
| 2. lie > lime (/m/ added)  | 7. say > same (/m/ added)  |
| 3. lie > line (/n/ added)  | 8. say > save (/v/ added)  |
| 4. lie > lies (/z/ added)  | 9. say > sail (/l/ added)  |
| 5. lie > light (/t/ added) | 10. say > sane (/n/ added) |

### Lesson 9: Prewriting

# Prerequisite Writing Skills



#### Primary Focus

Students will hold a writing utensil with a tripod (or pincer) grip and draw

✦ hooks. **Prerequisite Skill**

✦ Students will recognize and trace their own names. **Prerequisite Skill**

Students will use spatial words, such as *top*, *bottom*, *left*, *right*, and *middle*, while

✦ practicing handwriting. **TEKS K.3.C**

#### DRAW HOOKS ON A VERTICAL SURFACE (10 MIN.)

**Note:** Drawing hooks will prepare students to write letters such as 'g,' 'j,' and 'J.'

- Review the position words *top*, *bottom*, *left*, *right*, and *middle* with students, pointing out the top, bottom, left side, right side, and middle of one of the pieces of chart paper.
- Draw a hook on the board/chart paper. Tell students a hook is made by drawing a vertical line down and a small cup—it looks a lot like a fishhook.

J

#### Support

If students have trouble drawing hooks, you may draw stars on the paper to indicate where they should start each hook and dots to indicate where they should stop.

✦ **TEKS K.3.C** Identify and use words that name actions; directions; positions; sequences; categories such as colors, shapes, and textures; and locations.

- Invite students to trace hooks on their desks or in the air with their fingers.
- Have students draw hooks on the chart paper.
- Circulate the room, correcting grips and assisting students as they draw hooks.

## HOOK PRACTICE (15 MIN.)

- Have students settle into the proper writing posture.

### ➤ Digital Component 9.1

- Distribute and display Activity Page 9.1.
- Explain that the activity page shows some fishing lines, but each fishing line is missing its fishing hook.
- Tell students you are going to add a fishing hook to each fishing line. They should do the same on their activity pages.
- Show students how to add a fishing hook to one of the fishing lines by tracing the dotted line. As you draw, explain that you are adding a fishing hook to the fishing line by drawing a hook, starting at the star.
- Provide guided practice by continuing to demonstrate until students are ready to work independently.
- Once students have finished the front of the activity page, they should then complete the back of the activity page.
- Students may color the pictures and/or draw a picture containing at least one hook, if time permits.

## Activity Page 9.1



### Activity Page 9.1: Hook Practice

Collect Activity Page 9.1 to review and monitor students' ability to draw loops.

## Challenge

Have each student glue pictures of items beginning with the same sound as their name to the tracing paper. Alternatively, have each student draw pictures of items beginning with the same sound as their name on the tracing paper.

## Activity Page 9.2



## NAME TRACING (10 MIN.)

- Have each student trace their name using the affixed name card.
- Instruct each student to write the first three letters of their name below the tracing and then trace the rest of their name.
- Have students repeat this process until they have filled up the rest of the page.

End Lesson

# Take-Home Material

## HOOK PRACTICE

- Have students give Activity Page 9.2 to a family member.

---

## Lesson 9: Prerequisite Foundational Skills Remediation

# Additional Support

### MORE HELP WITH LISTENING FOR BEGINNING SOUNDS

#### Give Me a Sound

- Gather a collection of any **variety of blocks** (e.g., unit blocks or locking cubes).
- Tell students you will provide a word and would like for them to say the sound at the beginning of the word (e.g., “Give me the sound at the beginning of *sun*.”)
  - If students struggle to identify the beginning sound, repeat the word with the beginning sound drawn out: “sssssun.”)
- As students provide beginning sounds, give them a block. With each block students get a turn to place it, building a collective structure as the game continues.

### MORE HELP WITH WRITING STROKES

#### Writing Strokes

- Make one copy of **Activity Page TR 9.1** for each student.
- Have students trace the dotted lines to duplicate targeted strokes.



## 10

## UNIT ASSESSMENT

# Student Performance Assessment

## PRIMARY FOCUS OF LESSON

**Prerequisite Foundational Skills**

Students will isolate and pronounce the initial, medial vowel, and final sounds (phonemes) in three-phoneme (consonant-vowel-consonant, or CVC) words.

✦ **TEKS K.2.A.x**

Students will add initial or final phonemes to spoken one-syllable words and will

✦ blend to create new words. **TEKS K.2.A.viii**

**Prerequisite Writing Skills**

✦ Students will recognize and trace their own names. **Prerequisite Skill**

Students will use spatial words, such as *below*, while practicing

✦ handwriting. **Prerequisite Skill; TEKS K.3.C**

Students will blend spoken phonemes, onsets, and rimes to form one-syllable

✦ words. **TEKS K.2.A.vii; TEKS K.2.A.viii**

## FORMATIVE ASSESSMENT

Observation

Oral Blending Observation Record

✦ **TEKS K.2.A.viii**

Activity Pages 10.1, 10.2

Student Performance Assessment Part 1  
(Writing Strokes)

✦ **Prerequisite Skill**

Activity Page 10.3

Student Performance Assessment Part 2  
(Blending)

✦ **Prerequisite Skill**

✦ **TEKS K.2.A** Demonstrate phonological awareness by: (x) segmenting spoken one-syllable words into individual phonemes; (viii) blending spoken phonemes to form one-syllable words; (vii) blending spoken onsets and rimes to form simple words; **TEKS K.3.C** Identify and use words that name actions; directions; positions; sequences; categories such as colors, shapes, and textures; and locations..

## LESSON AT A GLANCE

|                                                                                         | Grouping                    | Time    | Materials                                                                                                                                                |
|-----------------------------------------------------------------------------------------|-----------------------------|---------|----------------------------------------------------------------------------------------------------------------------------------------------------------|
| <b>Prerequisite Foundational Skills</b>                                                 |                             |         |                                                                                                                                                          |
| Warm-Up: Sound Blending<br>(Phonological Awareness)                                     | Whole Group                 | 5 min.  |                                                                                                                                                          |
| Practice Blending:<br>- I Spy<br>- Add a Sound<br>(Phonological Awareness)              | Whole Group                 | 20 min. |                                                                                                                                                          |
| <b>Prerequisite Writing Skills</b>                                                      |                             |         |                                                                                                                                                          |
| Name Tracing                                                                            | Whole Group/<br>Independent | 10 min. | <input type="checkbox"/> crayons or dry-erase marker<br><input type="checkbox"/> tracing paper or sheet protector<br><input type="checkbox"/> name cards |
| Student Performance<br>Assessment:<br>- Part 1 (Writing Strokes)<br>- Part 2 (Blending) | Independent/<br>Whole Group | 25 min. | <input type="checkbox"/> Activity Pages 10.1–10.3<br><input type="checkbox"/> crayons                                                                    |
| <b>Take-Home Material</b>                                                               |                             |         |                                                                                                                                                          |
| Beginning/End Recognition                                                               |                             |         | <input type="checkbox"/> Activity Page 10.4                                                                                                              |

## ADVANCE PREPARATION

### Note to Teacher

This is the last lesson in Unit 2. During this lesson, you will assess students to determine their readiness for Unit 3.

The Unit 2 Student Performance Assessment has two parts. Part 1 tests students' ability to draw strokes and shapes taught in the first two units. Part 2 tests students' ability to blend sounds to form words.

For evaluating students' performance, see the Record Sheet for Unit 2 Student Performance Assessment, the Writing Strokes Scoring Guide, and the Writing Strokes: Class Summary Sheet located in Teacher Resources.

### Prerequisite Foundational Skills

- Note and prepare a mental list of classroom items containing three sounds.

### Prerequisite Writing Skills

- Provide each student with a sheet of tracing paper or plastic sheet protector. If you use the sheet protector, grease pencils or dry-erase markers will work best.

### Universal Access

- Bring in pictures to represent the words used in the Add a Sound activity, including *rain, raise, race, rake, rail, meat, feet, seat, neat, and sheet*.
- Note and prepare a mental list of colors, animals, or numbers containing three phonemes.
- Gather pictures that begin with the sounds of students' first names and provide glue.

## Lesson 10: Sound Blending

# Prerequisite Foundational Skills



## Primary Focus

Students will isolate and pronounce the initial, medial vowel, and final sounds (phonemes) in three-phoneme (consonant-vowel-consonant, or CVC)

✦ words. **TEKS K.2.A.x**





Students will add initial or final phonemes to spoken one-syllable words and will

✦ blend to create new words. **TEKS K.2.A.viii**

## WARM-UP (5 MIN.)

### Sound Blending

- Follow the steps outlined in Lesson 5.

|                                                                                     |                                                                                     |                                                                                     |                                                                                      |
|-------------------------------------------------------------------------------------|-------------------------------------------------------------------------------------|-------------------------------------------------------------------------------------|--------------------------------------------------------------------------------------|
| 1                                                                                   | 2                                                                                   | 3                                                                                   | 4                                                                                    |
|  |  |  |  |
| /k/                                                                                 | /i/                                                                                 | /s/                                                                                 | kiss                                                                                 |

- |                                  |                                |
|----------------------------------|--------------------------------|
| 1. /k/ ... /i/ ... /s/ > kiss    | 5. /k/ ... /oe/ ... /t/ > coat |
| 2. /s/ ... /i/ ... /p/ > sip     | 6. /n/ ... /u/ ... /t/ > nut   |
| 3. /sh/ ... /ae/ ... /p/ > shape | 7. /z/ ... /oo/ ... /m/ > zoom |
| 4. /t/ ... /o/ ... /m/ > Tom     | 8. /l/ ... /ie/ ... /k/ > like |

✦ **TEKS K.2.A** Demonstrate phonological awareness by (x) segmenting spoken one-syllable words into individual phonemes; (viii) blending spoken phonemes to form one-syllable words.

## PRACTICE BLENDING (20 MIN.)

### Challenge

Instead of choosing classroom objects, tell students you are thinking of colors, animals, or numbers. This gives students less support because there are no visual clues.

### I Spy

**Note:** This exercise will strengthen students' blending skills.

- Look around the room and mentally note items with names containing three sounds (e.g., a book, a rug, a light, a pen, a box, etc.).
- Say to the class, "I spy with my little eye a /b/ . . . /oo/ . . . /k/."
- Have students blend the word, using the arm motions, and point to the object in the room.
- Repeat until students have had sufficient blending practice.



### Observation: Oral Blending Observation Record

As you listen to students blend the sounds, make notes regarding their individual blending ability in the Oral Blending Observation Record.

### Support

If students are unsure, say the word in a segmented fashion:  
*ray* . . . /n/.

ENGLISH  
LANGUAGE  
LEARNERS



### Foundational Skills

#### Foundational Literacy Skills

When saying the stimulus words, show pictures of the following: *rain, raise, race, rake, rail, meat, feet, seat, neat, and sheet.*

ELPS 4.F

### Add a Sound

- Remind students a sound can be added to a word to make a new word.
- Say *ray*. Have students repeat the word.
- Ask students to name the word you would make by adding the /n/ sound to the end of *ray*. (*rain*)
- Repeat with the remaining words. Explain that items 6–10 involve adding a sound to the beginning of a word as opposed to the end.

- |                            |                              |
|----------------------------|------------------------------|
| 1. ray > rain (/n/ added)  | 6. eat > meat (/m/ added)    |
| 2. ray > raise (/z/ added) | 7. eat > feet (/f/ added)    |
| 3. ray > race (/s/ added)  | 8. eat > seat (/s/ added)    |
| 4. ray > rake (/k/ added)  | 9. eat > neat (/n/ added)    |
| 5. ray > rail (/l/ added)  | 10. eat > sheet (/sh/ added) |

- **Extension:** Once students have said the new word, invite them to discuss its meaning or to use it in a sentence.

Lesson 10: Student Performance Assessment

# Prerequisite Writing Skills



## Primary Focus

- ✦ Students will recognize and trace their own names. **Prerequisite Skill**

Students will use spatial words, such as *below*, while practicing handwriting.

- ✦ **Prerequisite Skill; TEKS K.3.C**

Students will blend spoken phonemes, onsets, and rimes to form one-syllable

- ✦ words. **TEKS K.2.A.vii; TEKS K.2.A.viii**

## NAME TRACING (10 MIN.)

- Have each student trace their name using the affixed name card.
- Instruct each student to write the first four letters of their name below the tracing and trace the rest of their name.
- Have students repeat this process.

## STUDENT PERFORMANCE ASSESSMENT (25 MIN.)

### Part 1 (Writing Strokes)

- Distribute Activity Pages 10.1 and 10.2.
- Ask students to print their names on the activity pages. Provide assistance for those who need it.
- Provide each student with a small piece of crayon.
- Instruct students to copy each shape on the activity pages.
- Use the assessment to guide remediation and reteaching. Keep copies of the assessment in your assessment portfolio.

- ✦ **Part 2 (Blending) TEKS K.2.A.vii; TEKS K.2.A.viii**

- Distribute Activity Page 10.3.
- Ask students to print their names on the activity page, and provide assistance for those who need it.

- ✦ **TEKS K.3.C** Identify and use words that name actions; directions; positions; sequences; categories such as colors, shapes, and textures; and locations; **TEKS K.2.A** Demonstrate phonological awareness by: (vii) blending spoken onsets and rimes to form simple words; (viii) blending spoken phonemes to form one-syllable words.

Activity Pages  
10.1–10.3



- Tell students you are going to say ten groups of sounds. They should blend each group of sounds in their heads to make a word and circle the matching picture on the activity page.
- Tell students to look at the first row of pictures.
- Instruct students to circle the picture of the /n/ ... /ee/.
- Complete the remaining rows.

- |                                 |                                 |
|---------------------------------|---------------------------------|
| 1. /n/ ... /ee/ (knee)          | 6. /h/ ... /ou/ ... /s/ (house) |
| 2. /m/ ... /oo/ ... /n/ (moon)  | 7. /p/ ... /i/ ... /g/ (pig)    |
| 3. /f/ ... /i/ ... /sh/ (fish)  | 8. /m/ ... /ou/ ... /s/ (mouse) |
| 4. /n/ ... /ie/ ... /f/ (knife) | 9. /k/ ... /a/ ... /t/ (cat)    |
| 5. /sh/ ... /oo/ (shoe)         | 10. /k/ ... /ae/ ... /k/ (cake) |

**Note:** Students have practiced blending the first four items listed for Part 2 of the assessment during Picture Card Blending, but they have not practiced blending the last six items. The last six items are particularly important because they test students' ability to generalize what they have learned.

## SCORING AND ANALYSIS

### Part 1 (Writing Strokes)

Refer to the Writing Strokes Assessment Scoring Guide. Mark the following points for each rating in the Writing Strokes Assessment Class Summary Sheet located in Teacher Resources:

Not Yet Ready (NYR) 0

Progressing (P) 0.5

Ready (R) 1

Mark students' total points in the Record Sheet for Unit 2 Student Performance Assessment located in Teacher Resources. Analyze each student's score as follows:

12–16 total points      excellent

8–11 points              good

7 or fewer points        weak

Make note of the particular writing strokes continuing to pose challenges for students, and provide additional practice in forming those specific writing strokes.

For students whose performance falls in the weak range, provide additional practice suggested in the Additional Support activities and the Pausing Point section entitled More Help with Drawing and Tracing. You may also want to provide additional fine motor skill reinforcement by offering the following activities: kneading modeling clay to make shapes, using tweezers to pick up bits of crumpled paper, transferring water from one container to another using an eyedropper, cutting and pasting, hole punching, lacing hole-punched cards, stringing beads, or playing with pegs and a pegboard.

## Part 2 (Blending)

Mark students' scores in the Record Sheet for Unit 2 Student Performance Assessment located in Teacher Resources. Analyze each student's score as follows:

|                   |           |
|-------------------|-----------|
| 8–10 points       | excellent |
| 6–7 points        | good      |
| 5 or fewer points | weak      |

Make note of any error patterns you notice for particular students. For example, are students confused by words that end the same (e.g., choosing *bee* for *knee* or *spoon* for *moon*)? This might indicate the student is not paying attention to the beginning sound. Or, is the opposite true with students disregarding the ending sound (e.g., choosing *nine* for *knife* or *ship* for *shoe*)? Provide practice for students whose performance falls in the weak range using Additional Support activities and any of the following Pausing Point sections: More Help with Blending Syllables, More Help with Oral Blending, or More Help with Listening for Beginning Sounds.

End Lesson

# Take-Home Material

## BEGINNING/END RECOGNITION

- Have students give Activity Page 10.4 to a family member.

Activity Page 10.4





---

## Lesson 10: Prerequisite Foundational Skills Remediation

# Additional Support

### MORE HELP WITH ORAL BLENDING

#### Simon Says

- Ask students to stand.
- Say a practice word, *hop*, blended into three phonemes: “Simon Says, /h/ /o/ /p/.”
- Ask students to blend the phonemes and demonstrate the action. (Encourage students to use blending motions they have learned to help them blend the sounds.)
- If a word is said (broken into phonemes) without “Simon Says” in front of it and students perform the action, they are “out” and sit down.
- Continue play until one student is left standing.
- Use the following words:

- |                            |                                  |
|----------------------------|----------------------------------|
| 1. wave > /w/ /ae/ /v/     | 7. march > /m/ /ar/ /ch/         |
| 2. sit > /s/ /i/ /t/       | 8. skip > /s/ /k/ /i/ /p/        |
| 3. shake > /sh/ /ae/ /k/   | 9. nod > /n/ /o/ /d/             |
| 4. read > /r/ /ee/ /d/     | 10. fall > /f/ /o/ /l/           |
| 5. tread > /t/ /r/ /e/ /d/ | 11. run (in place) > /r/ /u/ /n/ |
| 6. lean > /l/ /ee/ /n/     | 12. hug > /h/ /u/ /g/            |

### MORE HELP WRITING OWN NAME

#### Trace and Draw

- Make one copy of (**Activity Page TR 10.1**) for each student. Prepare the activity pages by writing one student’s name at the bottom of each page.
- Have students trace their names with a pencil or crayon and draw a self-portrait in the frame.

# Pausing Point

This is the end of Unit 2. You should pause here and spend additional time reviewing the material taught in Unit 2. Students may do any combination of the exercises listed below, in any order. The exercises are listed by unit objectives. You may find that different students need extra practice with different objectives. It can be helpful to have students focus on specific exercises in small groups.

## PAUSING POINT TOPIC GUIDE

### More Help with Blending Syllables

|                        |                                   |
|------------------------|-----------------------------------|
| Syllable Blending      | Page 101                          |
| Tap and Chase          | Page 101                          |
| Compound Word Pictures | Additional Support<br>Lessons 1–4 |
| Silly Monster          | Additional Support<br>Lesson 5    |

### More Help with Oral Blending

|                        |                                             |
|------------------------|---------------------------------------------|
| Sound Blending         | Page 102                                    |
| Picture Card Blending  | Page 102                                    |
| I Spy                  | Page 103                                    |
| Mystery Pictures       | Page 103                                    |
| Mystery Bag            | Page 103                                    |
| Have You Ever?         | Page 104                                    |
| Cut Up Pictures        | Page 104                                    |
| Touch It!              | Page 105                                    |
| Clap and Pat Sounds    | Additional Support<br>Lessons 6,7; Page 105 |
| I'm Going on a Trip    | Page 105                                    |
| Relay Blending         | Page 105                                    |
| Nursery Rhyme Blending | Page 106                                    |
| Name Blending          | Page 106                                    |
| Find My Word           | Additional Support<br>Lessons 3–6           |
| Simon Says             | Additional Support<br>Lesson 10             |

### **More Help with Listening for Beginning Sounds**

|                                |                                |
|--------------------------------|--------------------------------|
| Mixed-Up Monster               | Page 107                       |
| If Your Name Starts With . . . | Page 107                       |
| Guess Who?                     | Page 108                       |
| Find Things by Beginning Sound | Page 108                       |
| Give Me a Word                 | Additional Support<br>Lesson 8 |
| Give Me a Sound                | Additional Support<br>Lesson 9 |

### **Track from Left to Right and Top to Bottom**

|              |          |
|--------------|----------|
| Trace Lines  | Page 108 |
| Color Strips | Page 108 |

### **More Help with Drawing and Tracing**

|                                   |                                   |
|-----------------------------------|-----------------------------------|
| Trace and Copy                    | Page 109                          |
| Draw on a Vertical Surface        | Page 109                          |
| Draw on a Horizontal Surface      | Page 109                          |
| Decorate with the Writing Strokes | Page 109                          |
| Tray Tracing                      | Page 109                          |
| Writing Strokes                   | Additional Support<br>Lessons 7,9 |
| Decorate the Socks                | Additional Support<br>Lesson 8    |

### **Differentiate Shapes**

|                         |          |
|-------------------------|----------|
| Differentiate Shapes I  | Page 10  |
| Differentiate Shapes II | Page 110 |

### **Recognize the Beginning, Middle and End of a Row**

|                                  |          |
|----------------------------------|----------|
| Beginning/Middle/End Recognition | Page 110 |
|----------------------------------|----------|

### **More Help Writing Own Name**

|                |                                 |
|----------------|---------------------------------|
| Edible Names   | Page 110                        |
| Inedible Names | Page 110                        |
| Trace and Draw | Additional Support<br>Lesson 10 |

## MORE HELP WITH BLENDING SYLLABLES

### Syllable Blending

- Use the procedure from Lesson 1 using the words in the box.

- |                                   |                               |
|-----------------------------------|-------------------------------|
| 1. arm . . . pit > armpit         | 6. cow . . . boy > cowboy     |
| 2. base . . . ball > baseball     | 7. home . . . sick > homesick |
| 3. dough . . . nut > doughnut     | 8. mail . . . man > mailman   |
| 4. earth . . . quake > earthquake | 9. row . . . boat > rowboat   |
| 5. bed . . . time > bedtime       | 10. fire . . . fly > firefly  |

### Tap and Chase

- Have students sit in a circle. Tell students they are going to play a game similar to “Duck, Duck, Goose.”
- Tell students you are going to select a student to be “it.” You will tell that student a word (e.g., *sunshine*). Instead of saying “duck, duck, duck, duck,” the student who is “it” should say the two parts of the word separately (e.g., “sun, shine, sun, shine”) as they walk around the circle and tap their classmates’ heads. Instead of saying “goose,” the student who is “it” should say the word blended (e.g., “sunshine”). The rest of the rules are the same as those for “Duck, Duck, Goose.” Demonstrate for students if necessary.

- |                |                 |
|----------------|-----------------|
| 1. sun•shine   | 7. back•pack    |
| 2. doll•house  | 8. meat•ball    |
| 3. door•bell   | 9. moon•light   |
| 4. bed•time    | 10. pan•cake    |
| 5. play•ground | 11. sail•boat   |
| 6. sand•box    | 12. wheel•chair |

## MORE HELP WITH ORAL BLENDING

### Sound Blending

- Use the procedure from Lesson 3 using the words in the box.

- |                        |                        |
|------------------------|------------------------|
| 1. /i/ ... /f/ > if    | 6. /m/ ... /ie/ > my   |
| 2. /m/ ... /ae/ > may  | 7. /t/ ... /oe/ > toe  |
| 3. /sh/ ... /ie/ > shy | 8. /l/ ... /ie/ > lie  |
| 4. /i/ ... /z/ > is    | 9. /h/ ... /ee/ > he   |
| 5. /s/ ... /ee/ > see  | 10. /t/ ... /oo/ > two |

### Picture Card Blending

- Gather the following Blending Picture Cards: *sun*, *mouth*, *nose*, and *knife*.
- Show the first picture and say, "This is the sun."
- Tell the class the word *sun* contains three sounds.
- Say /s/ as you touch your shoulder.
- Say /u/ as you touch your elbow.
- Say /n/ as you touch your wrist.
- Say *sun* as you sweep your hand down your arm, and have students do the same.
- Place the picture of the mouth next to the picture of the sun. Repeat the procedures outlined above with the word *mouth*.
- Displaying both pictures, ask the class if they can find the picture of the /m/ ... /ou/ ... /th/. (Say the word in a segmented fashion, with a one-second pause between the sounds.)
- Ask students to find the picture of the /s/ ... /u/ ... /n/.
- Remove the pictures of the sun and the mouth and repeat the above procedures with the next two pictures (*nose* and *knife*).
- Display all four pictures and ask the class to find one of them, while you say the word in a segmented fashion. Repeat until all four pictures have been identified.

### Blending Picture Cards



## I Spy

- Look around the room and mentally note items with names containing three sounds (e.g., a book, a rug, a light, a pen, a box).
- Say to the class, “I spy with my little eye a /b/ . . . /oo/ . . . /k/.”
- Have students blend the word, using the arm motions, and point to the object in the room.
- Repeat until students have had sufficient blending practice.

## Mystery Pictures

- Gather previously taught Blending Picture Cards.
- Hold the Blending Picture Cards so students cannot see the pictures.
- Tell students you will say the sounds in a word and you want them to blend the sounds to identify the picture on the card.
- Say the target word in a segmented fashion (e.g., “/m/ . . . /ou/ . . . /th/”).
- When a student answers correctly, reveal the card.
- Repeat with additional Blending Picture Cards.
- **Variation:** If students are able to blend successfully and identify pictures they have seen previously, you may begin to introduce cards they have not seen before.

## Mystery Bag

**Note:** You may add riddles to this game. For example, say, “I’m holding something you can write with. It sounds like /p/ . . . /e/ . . . /n/.” Be careful not to overemphasize the riddles. The point of this exercise is to allow students to practice blending.

- Gather a number of objects and review their names with students before placing them in a bag. Make sure the name of each object has no more than three sounds.
- Explain that you want students to guess what you have in your bag.
- Reach into the bag and grab one of the objects, but do not pull the object out of the bag.
- Say the name of the object in a segmented fashion (e.g., “/p/ . . . /e/ . . . /n/”), and ask students to blend the word.
- Reveal the object once students have said the blended word.
- Repeat with the remaining objects.

## Have You Ever?

- Teach students the following verse to the tune of “Have You Ever Seen a Lassie?”

*Have you ever seen a /k/ ... /a/ ... /t/, /k/ ... /a/ ... /t/,  
/k/ ... /a/ ... /t/?*

*Have you ever seen a /k/ ... /a/ ... /t/?*

*What did you see?*

- Have the class answer the last line with the blended word. (*cat*)
- Repeat using three-sound words (e.g., *dog, fish, moth, rose*).
- **Variation:** Sing the following verses to the tune of “The Wheels on the Bus.”

*The sounds in the word go /d/ ... /o/ ... /g/, /d/ ... /o/ ... /g/, /d/  
... /o/ ... /g/,*

*The sounds in the word go /d/ ... /o/ ... /g/. Can you guess that  
word?*

## Cut Up Pictures

**Note:** This exercise allows students to physically manipulate something associated with the sounds in a word by moving pieces of a picture of the word.

- Gather pictures of objects having names containing only three sounds.
- Cut each picture into three pieces—the first piece represents the first sound in the name of the object, the second piece represents the second sound, and the third piece represents the third sound.
- Place the three pieces in order on an easel or the board, leaving space between them.
- Say the name of the picture in a segmented fashion, pointing to each piece as you say the sound it represents.
- Have students repeat the segmented word.
- Move the pieces together as you say the blended word.
- Have students repeat the blended word.
- Repeat with several pictures.

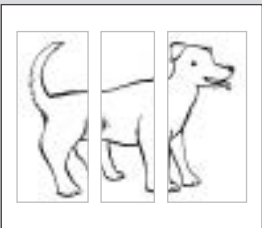

## Touch It!

**Note:** This exercise allows students to “feel” sounds by having them touch different parts of their bodies for each sound in a word.

- Say a three-sound word in a segmented fashion.
- Have students say the first sound as they touch their shoulders, the second sound as they touch their waists, and the third sound as they touch their toes (e.g., /r/ [touch shoulders], /u/ [touch waist], /g/ [touch toes]).
- Then have students stand up and thrust their arms in the air as they say the blended word (e.g., “RUG!”).
- Repeat with several words.

## Clap and Pat Sounds

**Note:** This exercise allows students to “feel” sounds by clapping them.

- Say a three-sound word in a segmented fashion, clapping once for each sound (e.g., “/b/ [clap] . . . /i/ [clap] . . . /n/ [clap]”).
- Say the blended word as you pat your lap: *bin*.
- Have students practice this with a number of words.

## I’m Going on a Trip

- Explain that you are going on a trip and you want students to guess the objects you are taking.
- Say the name of a three-sound object in a segmented fashion, touching your shoulder, elbow, and wrist for the individual sounds (e.g., “/sh/ . . . /oo/ . . . /z/”).
- Have students repeat the segmented sounds and then say the blended word. (shoes)
- Repeat with additional objects.
- **Note:** Be careful not to make this a riddle game. The point of this exercise is to allow students to practice blending.

## Relay Blending

- Divide the class into two teams and have each team form a line.
- Say a segmented word (e.g., “/s/ . . . /a/ . . . /t/”), and ask the first student in each line to blend it.
- The student who is first to blend the word correctly gets a point for his or her team. Both students should then move to the back of their respective line.



- If neither student can blend the word correctly, have both students move to the back of their respective line and let the next students in line take a turn.

### Nursery Rhyme Blending

**Note:** Look for other opportunities during the school day to segment words students can blend. When calling on Ben, ask for /b/ . . . /e/ . . . /n/. When it is time for gym, say it is time for /j/ . . . /i/ . . . /m/, etc.

- Select a nursery rhyme with which students are familiar and note the words having two or three sounds.
- Tell students you are going to recite a nursery rhyme, but you will say some of the words in a segmented fashion.
- Recite the nursery rhyme for the class. When you get to a two- or three-sound word, say it in a segmented fashion.
- Pause and ask students to repeat the segmented sounds. Then have students blend the word.

### Name Blending

**Note:** This program treats /er/ (as in *her*), /ar/ (as in *car*), and /or/ (as in *for*) as single vowel sounds rather than vowel + consonant combinations. This is because adjacent sounds slightly alter each other—a process referred to as co-articulation. Occasionally co-articulation occurs to such a degree that a new phoneme is created. This is the case with /er/, /ar/, and /or/. Thus, you should segment a name such as *Mark* like this: /m/ /ar/ /k/.

In this exercise students will practice blending the segmented names of their classmates. Segmenting student names, as opposed to random words, drastically reduces the number of possible responses for students. Additionally, hearing the sounds in their names is easier for most students than hearing the sounds in random words.

Practice segmenting the students' names in advance. With practice it will become automatic and will not require additional preparation.

- Pick a student's name that contains only two or three sounds (e.g., *Sue* [/s/ /oo/] or *Ben* [/b/ /e/ /n/]).
- Say the name in a segmented fashion and ask students to raise their hands if they know what name you said.
- Once you have finished segmenting the two- and three-sound names, proceed to the longer ones.

## MORE HELP WITH LISTENING FOR BEGINNING SOUNDS

### Mixed-Up Monster

**Note:** This exercise allows students to practice listening for the beginning sound in a word. You will need to provide a puppet for this exercise.

Instead of using classroom objects, you could do this exercise with the Blending Picture Cards.

- Point to different objects in your classroom and have students identify them.
- Introduce the class to the puppet, the Mixed-Up Monster. Tell students he is a friendly monster. Sometimes he needs help pronouncing words correctly.
- Have the Mixed-Up Monster point to one of the objects and incorrectly identify it by mixing up the first sound (e.g., “That’s a fesk!” for *desk*).
- Ask students whether or not the Mixed-Up Monster pronounced the name of the object correctly. Have them correct the Mixed-Up Monster.
- Have the monster pronounce the names of other objects correctly and incorrectly. As you discuss the objects, talk about the initial sounds and the mistakes the monster makes (e.g., “The monster said /f/ instead of /d/”).

### If Your Name Starts With . . .

- As a class, review the first sound in each of the students’ names.
- Sing the following verses to the tune of “If You’re Happy and You Know It.”

*If your name starts with (sound), clap your hands.*

*If your name starts with (sound), clap your hands.*

*If your name starts with (sound), then you surely want to show it.*

*If your name starts with (sound), clap your hands.*

- Be sure to say sounds, not letter names.
- Continue until each student has had a chance to respond or until the game is no longer useful.
- **Variation:** Change “clap your hands” to a different action will hold students’ attention longer (e.g., stand up tall, wink your eye, touch your nose, touch your toes, or stomp your feet).

## Guess Who?

- Tell students you are thinking of a person in the classroom. You want students to guess who it is but first you will give them a hint.
- Tell students the first sound of the person's name. Be sure to elongate the sound if it can be stretched out, or repeat the sound several times if it cannot.
- Have students identify the person.
- Repeat with eight to ten more names.

## Find Things by Beginning Sound

- See Lesson 7 for /m/ and /f/ and Lesson 8 for /sh/ and /n/, or do this exercise with pictures for other target sounds.

## TRACK FROM LEFT TO RIGHT AND TOP TO BOTTOM

### Trace Lines

- Draw a straight line, a zigzag, and a wavy line horizontally on a sheet of paper.
- Photocopy the sheet.
- Give each student a photocopy of the sheet and a small piece of crayon.
- Tell students to trace each line from left to right. (If necessary, model this on the board/chart paper.)

**Note:** You can place a green “start star” on the left of each sheet and a red “stop dot” on the right to help students with left-to-right directionality.

Laminate the sheets to allow students to practice the exercise repeatedly with dry-erase markers.

### Color Strips

- Give each student a strip of paper that has a row of colored dots on it. The dot on the far left should be green and the dot on the far right should be red. The middle dots should be other colors. All students strips should be the same color sequence.
- Tell students you are going to say the names of the colors on the strip from left to right. Students should touch each color as you say its name.
- Say the color names from left to right.
- Repeat multiple times.

## MORE HELP WITH DRAWING AND TRACING

### Trace and Copy

- Distribute Activity Pages PP.1, PP.2, PP.3, PP.4, or PP.5.
- Have students first trace and then copy the strokes.

**Note:** Laminating the sheets will allow students to practice the exercise repeatedly with dry-erase markers.

### Draw on a Vertical Surface

- Have students draw cups (see Lesson 1), humps (see Lesson 2), zigzags (see Lesson 3), wavy lines (see Lesson 4), spirals (see Lesson 5), + (see Lesson 6), × (see Lesson 6), loops (see Lesson 7), canes (see Lesson 8), or hooks (see Lesson 9) on pieces of chart paper taped to the wall.

### Draw on a Horizontal Surface

- Have students sit at their desks and draw cups (see Lesson 1), humps (see Lesson 2), zigzags (see Lesson 3), wavy lines (see Lesson 4), spirals (see Lesson 5), + (see Lesson 6), × (see Lesson 6), loops (see Lesson 7), canes (see Lesson 8), or hooks (see Lesson 9) on sheets of paper.

### Decorate with the Writing Strokes

- Using Activity Pages PP.6, PP.7, PP.8 and/or PP.9, tell students to use different color crayons to make their choice of any combination of the writing strokes to decorate the interior of the large shapes on the activity pages. Provide a display of the all the writing strokes students have learned thus far to remind them of their many choices. You may want to demonstrate making small controlled writing strokes to fill the space. Students may also find it enjoyable to create simple patterns of different color writing strokes.

### Tray Tracing

- Give each student a shallow tray containing sand or rice.
- Have students trace any of the Unit 2 shapes in the sand or rice.

## DIFFERENTIATE SHAPES

### Differentiate Shapes I

- Distribute Activity Page PP.10.
- For each row, have students circle the shape that is the same as the shape on the left and cross out the two shapes that are different.

Activity Pages  
PP.1–PP.9



Activity Page PP.10





## Differentiate Shapes II

- Distribute Activity Page PP.11.
- For each row, have students circle the shape that is the same as the shape on the left and cross out the shape that is different.

## RECOGNIZE THE BEGINNING, MIDDLE, AND END OF A ROW

### Beginning/Middle/End Recognition

- Distribute Activity Page PP.12.
- Tell students to look at the first row.
- Have students color the item at the *beginning* of the row green.
- Have students color the item in the *middle* of the row yellow.
- Have students color the item at the *end* of the row red.
- Complete the remaining rows. Make sure to emphasize the terms *beginning*, *middle*, and *end*.



## MORE HELP WRITING OWN NAME

### Edible Names

- Give each student a paper plate or a paper towel and an assortment of round and linear cereal, crackers, and/or pretzels.
- Ask students to “write” their names using the snacks.

**Note:** Be sure to follow your school’s policy regarding food distribution and allergies.

### Inedible Names

- If you are concerned about using food then, have students write their names using different materials (e.g., paint, shaving cream, pipe cleaners, modeling clay, chalk). To make this a bit more challenging, have students write their names with their eyes closed.

# Teacher Resources

|              |          |
|--------------|----------|
| Kindergarten | Skills 2 |
|--------------|----------|

**Teacher Guide**

# Teacher Resources

Oral Blending Observation Record—Unit 2

Sample Oral Blending Observation Record

Writing Strokes Assessment Scoring Guide

Writing Strokes Assessment Class Summary Sheet

Record Sheet for Unit 2 Student Performance Assessment

Additional Support Activity Pages

Activity Book Answer Key

Appendices

Texas Essential Knowledge and Skills Correlation Chart

English Language Proficiency Standards Correlation Chart

## ORAL BLENDING OBSERVATION RECORD—UNIT 2

- ✓ - Correctly Blended (write the word blended)
  - ✗ - Incorrectly Blended (write the word given/the sounds blended)
- Subtotal = number of correct responses/total responses per student

| Student | Lesson | Lesson | Lesson | Lesson | Lesson | Subtotal |
|---------|--------|--------|--------|--------|--------|----------|
|         |        |        |        |        |        | /        |
|         |        |        |        |        |        | /        |
|         |        |        |        |        |        | /        |
|         |        |        |        |        |        | /        |
|         |        |        |        |        |        | /        |
|         |        |        |        |        |        | /        |
|         |        |        |        |        |        | /        |
|         |        |        |        |        |        | /        |
|         |        |        |        |        |        | /        |
|         |        |        |        |        |        | /        |
|         |        |        |        |        |        | /        |
|         |        |        |        |        |        | /        |
|         |        |        |        |        |        | /        |
|         |        |        |        |        |        | /        |
|         |        |        |        |        |        | /        |
|         |        |        |        |        |        | /        |
|         |        |        |        |        |        | /        |
|         |        |        |        |        |        | /        |



## SAMPLE ORAL BLENDING OBSERVATION RECORD

- ✓ - Correctly Blended (write the word blended)
  - ✗ - Incorrectly Blended (write the word given/the sounds blended)
- Subtotal = number of correct responses/total responses per student

| Student    | Lesson 2      | Lesson 3      | Lesson 4    | Lesson 5    | Subtotal |
|------------|---------------|---------------|-------------|-------------|----------|
| B. Allen   | ✓             |               |             |             | 1 /1     |
| S. Bishop  | ✗ (shoe/chew) |               |             |             | 0 /1     |
| L. Bronson |               | ✓             |             | ✓           | 2 /2     |
| J. Chen    |               |               | ✓           |             | 1 /1     |
| T. Ellis   |               |               |             | ✗ (mat/mad) | 0 /1     |
| B. Finn    |               |               |             | ✓           | 1 /1     |
| J. Joyce   |               |               | ✓           |             | 1 /1     |
| R. Little  |               | ✗ (mess/mez)  |             |             | 0 /1     |
| K. Miller  |               |               |             |             | 0 /0     |
| M. Moore   |               |               | ✓           |             | 1 /1     |
| P. Nuñez   | ✓             |               |             | ✓           | 2 /2     |
| G. O'Neill |               | ✗ (sign/sigh) | ✗ (fun/sun) |             | 0 /2     |
| K. Powell  |               |               |             |             | 0 /0     |
| T. Smith   |               | ✓             |             |             | 1 /1     |
| W. Stein   | ✗ (off/of)    |               |             |             | 0 /1     |
|            |               |               |             |             | /        |









## SAMPLE ORAL BLENDED OBSERVATION RECORD

- ✓ - Correctly Blended (write the word blended)
  - ✗ - Incorrectly Blended (write the word given/the sounds blended)
- Subtotal = number of correct responses/total responses per student

| Student    | Lesson 6       | Lesson 7      | Lesson 8      | Lesson 9 | Subtotal |
|------------|----------------|---------------|---------------|----------|----------|
| B. Allen   | ✓              |               |               |          | 1 /1     |
| S. Bishop  |                |               |               | ✓        | 1 /1     |
| L. Bronson |                |               |               |          | 0 /0     |
| J. Chen    |                | ✗ (feet/feed) |               |          | 0 /1     |
| T. Ellis   | ✓              |               |               |          | 1 /1     |
| B. Finn    |                |               | ✓             |          | 1 /1     |
| J. Joyce   | ✗ (wish/witch) |               |               |          | 0 /1     |
| R. Little  |                | ✗ (cat/cad)   | ✓             |          | 1 /2     |
| K. Miller  |                |               | ✗ (five/fife) | ✓        | 1 /2     |
| M. Moore   |                | ✓             |               |          | 1 /1     |
| P. Nuñez   |                |               |               |          | 0 /0     |
| G. O'Neill |                | ✓             |               |          | 1 /1     |
| K. Powell  | ✓              |               | ✓             |          | 2 /2     |
| T. Smith   |                |               |               | ✓        | 1 /1     |
| W. Stein   |                |               |               | ✓        | 1 /1     |
|            |                |               |               |          | /        |

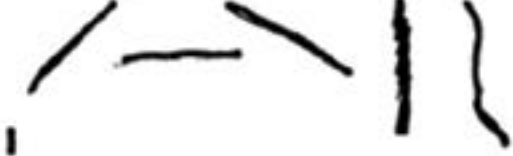
## WRITING STROKES ASSESSMENT SCORING GUIDE

Rate each student's attempt to copy each writing stroke as Not Yet Ready (NYR), Progressing (P), or Ready (R).

|                                                                                     |                                                                                                                                                                                                                                                                                                 |
|-------------------------------------------------------------------------------------|-------------------------------------------------------------------------------------------------------------------------------------------------------------------------------------------------------------------------------------------------------------------------------------------------|
|    | <p>Not Yet Ready (NYR): No attempt or mark on paper whatsoever.</p> <hr/> <p>Progressing (P):</p>  <hr/> <p>Ready (R):</p>  |
|  | <p>NYR: No attempt or mark on paper whatsoever.</p> <hr/> <p>P:</p>  <hr/> <p>R:</p>                                   |
|  | <p>NYR: No attempt or mark on paper whatsoever.</p> <hr/> <p>P:</p>  <hr/> <p>R:</p>                                  |

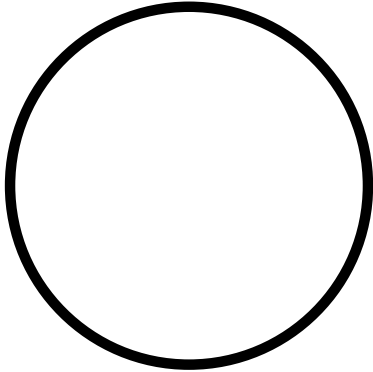

NYR:



P:

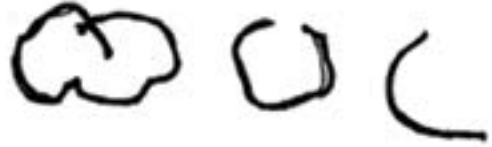

R:

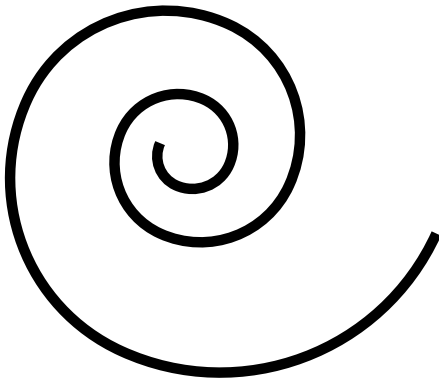
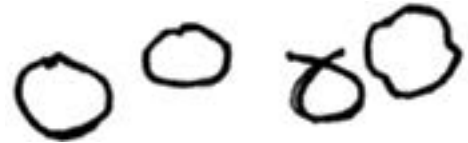

NYR:



P:

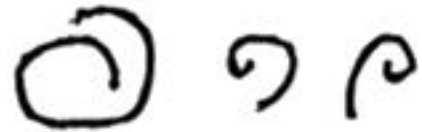

R:

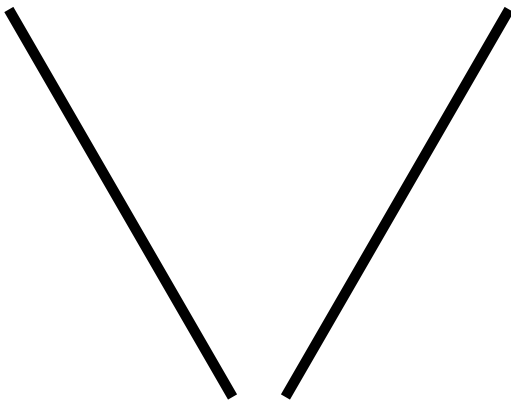

NYR:



P:



R:

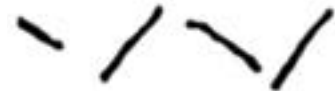

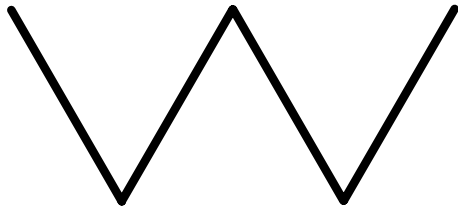

NYR:



P:



R:

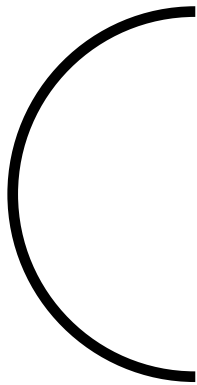

NYR:



P:



R:

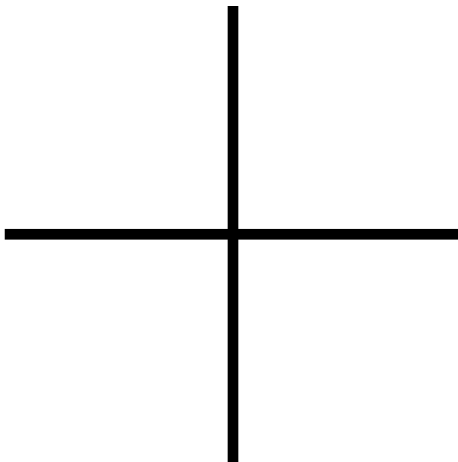

NYR:

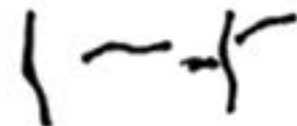

P:



R:

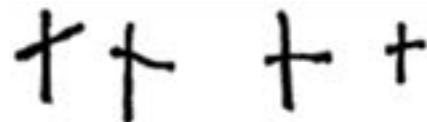

|                                                                                     |                                                                                                                                                                                                                                                                                                            |
|-------------------------------------------------------------------------------------|------------------------------------------------------------------------------------------------------------------------------------------------------------------------------------------------------------------------------------------------------------------------------------------------------------|
|    | <p>NYR:</p>  <hr/> <p>P:</p>  <hr/> <p>R:</p>      |
|   | <p>NYR:</p>  <hr/> <p>P:</p>  <hr/> <p>R:</p>   |
|  | <p>NYR:</p>  <hr/> <p>P:</p>  <hr/> <p>R:</p>  |

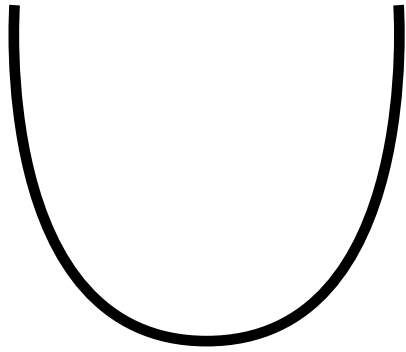

NYR:



P:



R:



NYR:



P:



R:

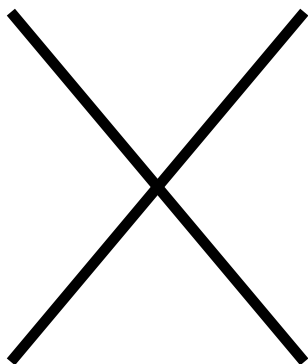

NYR:

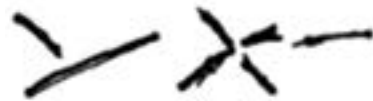

P:



R:

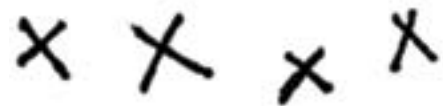

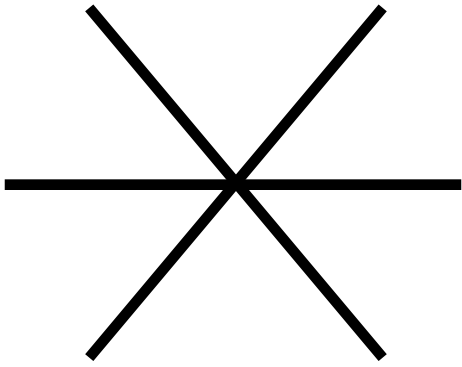

NYR:



P:



R:





**WRITING STROKES ASSESSMENT CLASS SUMMARY SHEET**

|                 |  |  |  |  |  |  |  |  |  |  |  |  |  |  |
|-----------------|--|--|--|--|--|--|--|--|--|--|--|--|--|--|
| <b>Name</b>     |  |  |  |  |  |  |  |  |  |  |  |  |  |  |
| horizontal line |  |  |  |  |  |  |  |  |  |  |  |  |  |  |
| vertical line   |  |  |  |  |  |  |  |  |  |  |  |  |  |  |
| circle          |  |  |  |  |  |  |  |  |  |  |  |  |  |  |
| spiral          |  |  |  |  |  |  |  |  |  |  |  |  |  |  |
| diagonal lines  |  |  |  |  |  |  |  |  |  |  |  |  |  |  |
| zigzag          |  |  |  |  |  |  |  |  |  |  |  |  |  |  |
| moon            |  |  |  |  |  |  |  |  |  |  |  |  |  |  |
| plus sign       |  |  |  |  |  |  |  |  |  |  |  |  |  |  |
| cane            |  |  |  |  |  |  |  |  |  |  |  |  |  |  |
| hook            |  |  |  |  |  |  |  |  |  |  |  |  |  |  |
| hump            |  |  |  |  |  |  |  |  |  |  |  |  |  |  |
| cup             |  |  |  |  |  |  |  |  |  |  |  |  |  |  |
| wavy line       |  |  |  |  |  |  |  |  |  |  |  |  |  |  |
| X               |  |  |  |  |  |  |  |  |  |  |  |  |  |  |
| loop            |  |  |  |  |  |  |  |  |  |  |  |  |  |  |
| Total           |  |  |  |  |  |  |  |  |  |  |  |  |  |  |

**RECORD SHEET FOR UNIT 2 STUDENT PERFORMANCE ASSESSMENT**

| <b>Student</b> | <b>Part One</b> | <b>Part Two</b> | <b>Notes</b> |
|----------------|-----------------|-----------------|--------------|
|                |                 |                 |              |
|                |                 |                 |              |
|                |                 |                 |              |
|                |                 |                 |              |
|                |                 |                 |              |
|                |                 |                 |              |
|                |                 |                 |              |
|                |                 |                 |              |
|                |                 |                 |              |
|                |                 |                 |              |
|                |                 |                 |              |
|                |                 |                 |              |
|                |                 |                 |              |
|                |                 |                 |              |
|                |                 |                 |              |
|                |                 |                 |              |
|                |                 |                 |              |
|                |                 |                 |              |
|                |                 |                 |              |



# Additional Support Activity Pages

|              |          |
|--------------|----------|
| Kindergarten | Skills 2 |
|--------------|----------|

**Teacher Guide**

NAME: \_\_\_\_\_

DATE: \_\_\_\_\_

# TR 1.1

Directions: Have students use this activity page in the Compound Word Pictures activity.

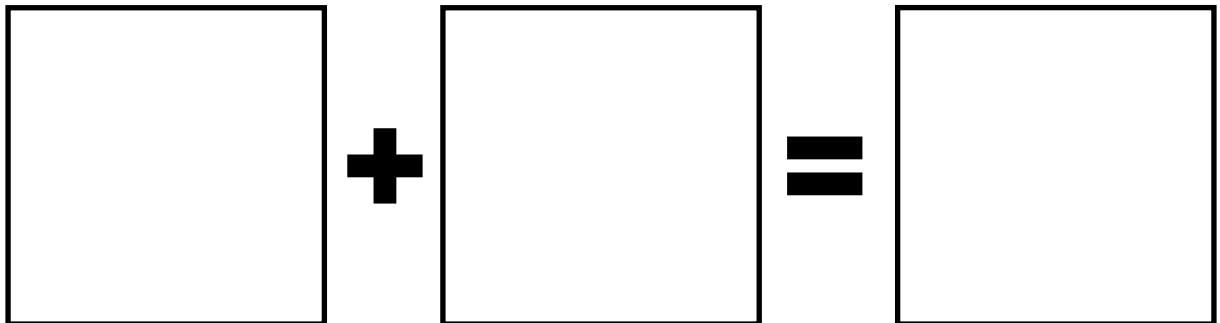
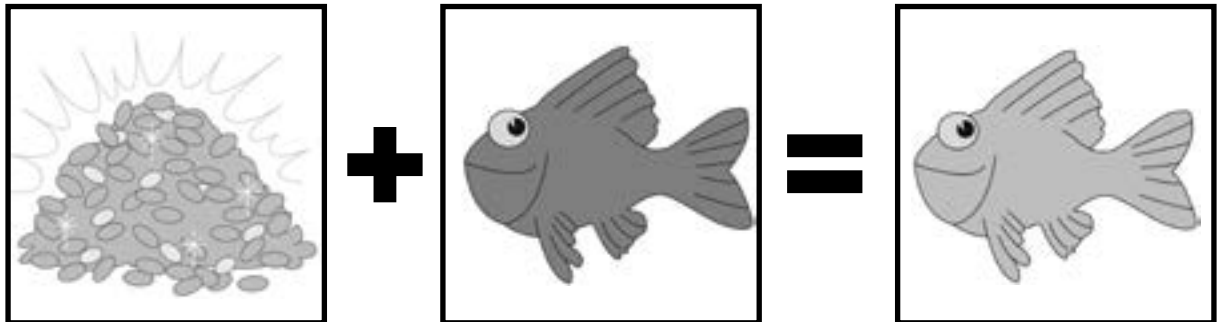









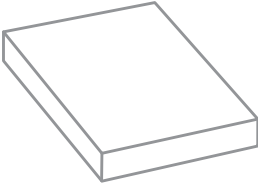



NAME: \_\_\_\_\_

DATE: \_\_\_\_\_

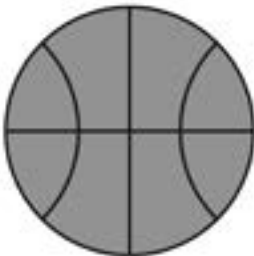
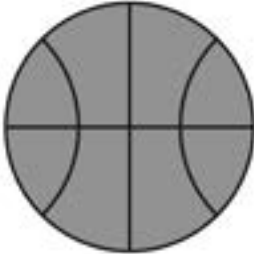
# TR 1.2

Directions: Have students cut out the images and use them for creating compound words in the Compound Word Pictures activity.









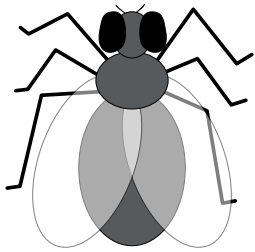

|                                                                                     |                                                                                      |                                                                                       |                                                                                     |
|-------------------------------------------------------------------------------------|--------------------------------------------------------------------------------------|---------------------------------------------------------------------------------------|-------------------------------------------------------------------------------------|
|    |    |    |  |
|   |   |   |                                                                                     |
|  |  |  |                                                                                     |
|  |  |  |                                                                                     |

NAME: \_\_\_\_\_

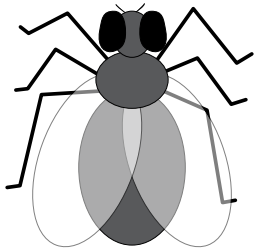
DATE: \_\_\_\_\_

# TR 2.1

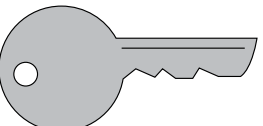
Directions: Have students cut out the images and use them for creating compound words in the Compound Word Pictures activity.

|                                                                                     |                                                                                     |                                                                                                                                                                         |
|-------------------------------------------------------------------------------------|-------------------------------------------------------------------------------------|-------------------------------------------------------------------------------------------------------------------------------------------------------------------------|
|    |    |   |
|    |   |                                                                                     |
|  |  |                                                                                    |
|  |  |                                                                                    |

NAME: \_\_\_\_\_

DATE: \_\_\_\_\_

# TR 3.1

Directions: Have students cut out the images and use them for creating compound words in the Compound Word Pictures activity.

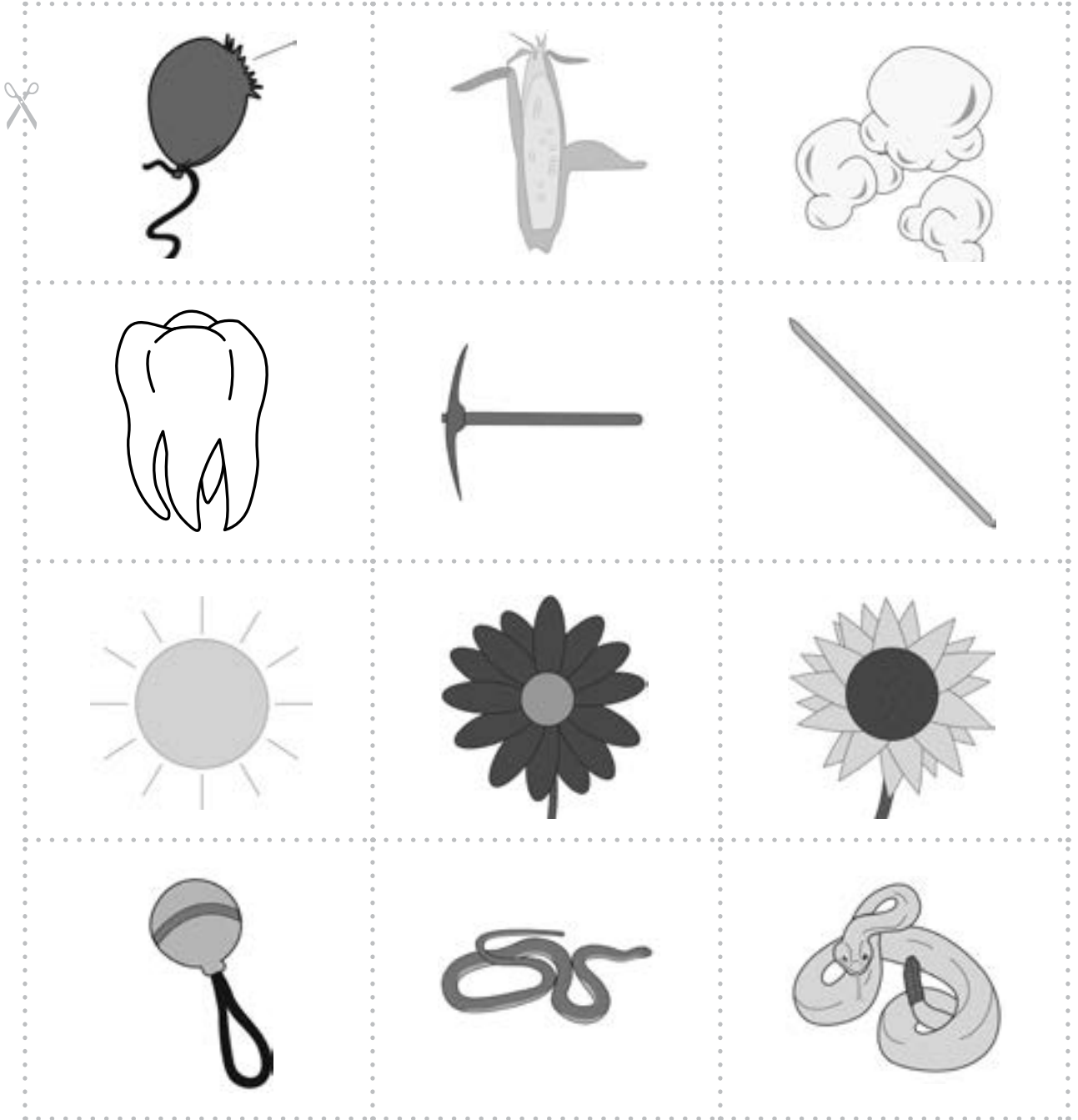



NAME: \_\_\_\_\_

DATE: \_\_\_\_\_

# TR 3.2

Directions: Pronounce the names of objects on the page in segmented fashion (pause between phonemes).  
Students blend the sounds and point to the corresponding image. Images represent: cow, dog, duck, horse,  
bee, pig, cat, sheep, bird.



NAME: \_\_\_\_\_

DATE: \_\_\_\_\_

# TR 4.1

Directions: Have students cut out the images and use them for creating compound words in the Compound Word Pictures activity.

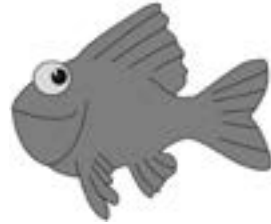

NAME: \_\_\_\_\_

DATE: \_\_\_\_\_

# TR 4.2

Directions: Pronounce the names of objects on the page in segmented fashion (pause between phonemes).  
Students blend the sounds and point to the corresponding image. Images represent: head, nose, mouth, ear,  
chin, knee, foot, leg, thumb.

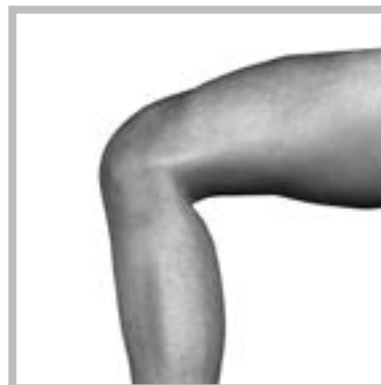

NAME: \_\_\_\_\_

DATE: \_\_\_\_\_

# TR 5.1

*Directions: Pronounce, with a pause between syllables, the objects Silly Monster sees. Students blend the syllables and point to the object. Or, students practice segmenting by saying the names of objects you point to broken into syllables.*



NAME: \_\_\_\_\_

DATE: \_\_\_\_\_

# TR 5.2

Directions: Pronounce the names of objects on the page in segmented fashion (pause between phonemes).  
Students blend the sounds and point to the corresponding image. Images represent: sun, moon, star, rain,  
snow, kite, bird, bee, air.

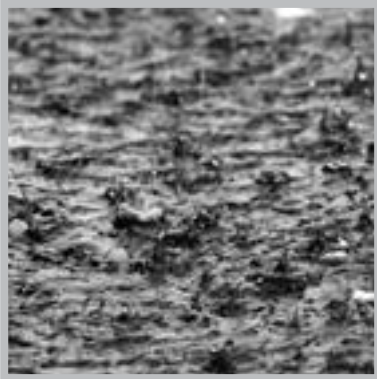

NAME: \_\_\_\_\_

DATE: \_\_\_\_\_

# TR 6.1

*Directions: Pronounce the names of objects on the page in segmented fashion (pause between phonemes). Students blend the sounds and point to the corresponding image. Images represent: car, bus, van, cab, jeep, boat, jet, bike, sled.*











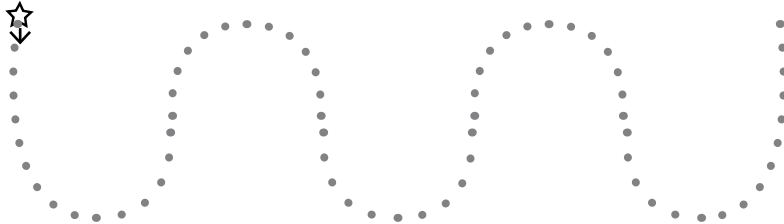

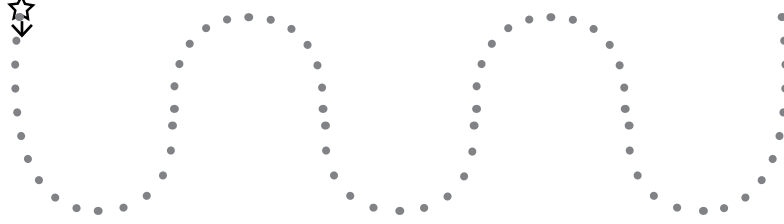
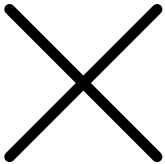

NAME: \_\_\_\_\_

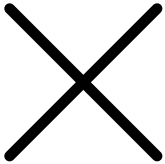
DATE: \_\_\_\_\_

# TR 7.1

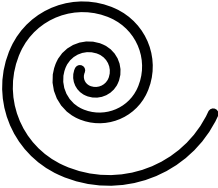
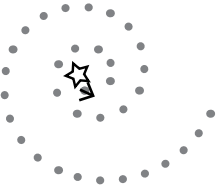
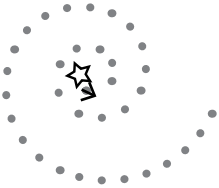
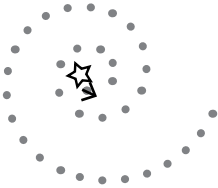
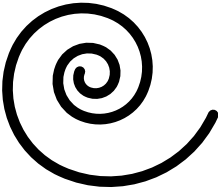
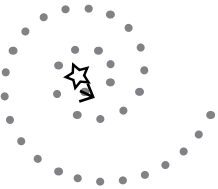
Directions: Students trace the dotted lines, starting at the star, and complete remaining strokes for mixed writing strokes practice.

|                                                                                     |                                                                                                                                                                                                                                                                |
|-------------------------------------------------------------------------------------|----------------------------------------------------------------------------------------------------------------------------------------------------------------------------------------------------------------------------------------------------------------|
|    |                                                                                                                                                                              |
|    |                                                                                                                                                                              |
|   |       |
|  |    |
|  |    |
|  |                                                                                         |

NAME: \_\_\_\_\_

DATE: \_\_\_\_\_

# TR 8.1

*Directions: Students first trace the dotted hooks and complete hooks for the remaining socks. Any writing strokes can be used to fill in designs on the socks.*

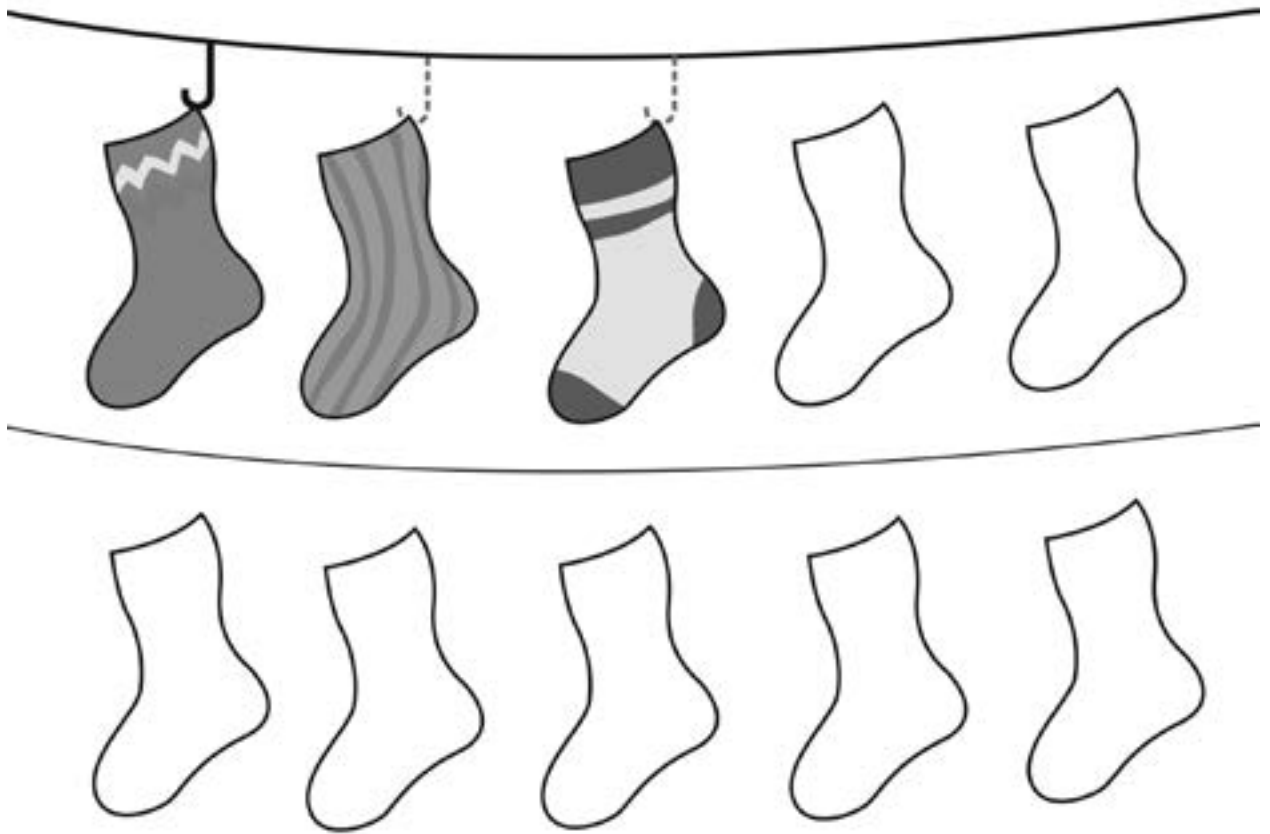



NAME: \_\_\_\_\_

DATE: \_\_\_\_\_

# TR 9.1

Directions: Students trace the dotted lines, starting at the star, and complete remaining strokes for mixed writing strokes practice.

|  |  |  |  |
|--|--|--|--|
|  |  |  |  |
|  |  |  |  |
|  |  |  |  |
|  |  |  |  |
|  |  |  |  |
|  |  |  |  |

NAME: \_\_\_\_\_

DATE: \_\_\_\_\_

# TR 10.1

*Directions: Write the student's name in the box for recognition and/or tracing practice. Have students fill the frame with a photo or self-portrait.*

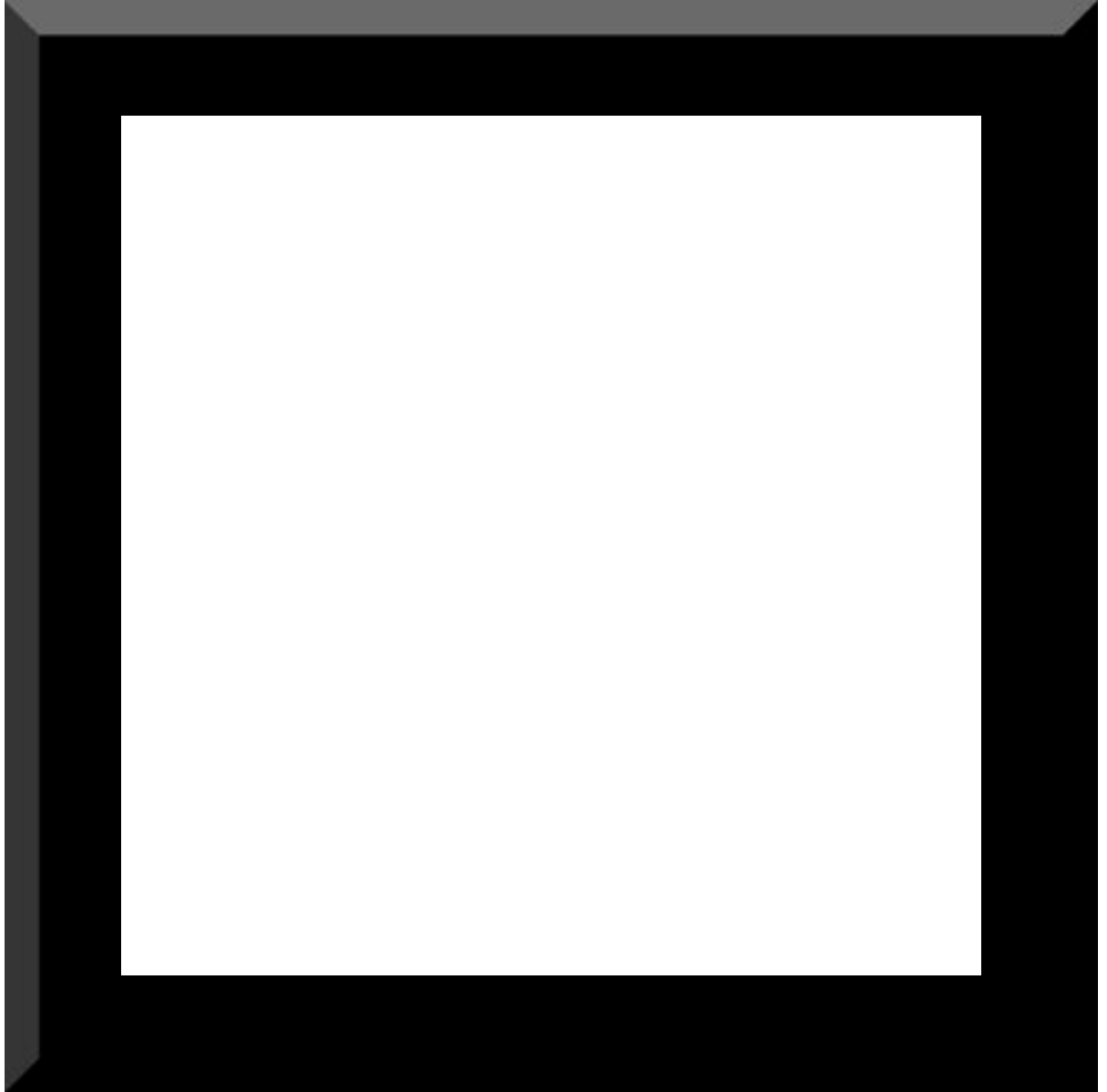

\_\_\_\_\_

-----

# ACTIVITY BOOK ANSWER KEY

NAME: \_\_\_\_\_ DATE: \_\_\_\_\_ 3.2 Activity Page

Directions: For each row, have students circle the shape that is the same as the shape on the left and cross out the shape that is different.

|  |  |  |
|--|--|--|
|  |  |  |
|  |  |  |
|  |  |  |
|  |  |  |
|  |  |  |
|  |  |  |

Skills 2 13

NAME: \_\_\_\_\_ DATE: \_\_\_\_\_ 10.3 Assessment

|   |              |              |
|---|--------------|--------------|
| V | <del>W</del> | V            |
| C | <del>C</del> | <del>C</del> |
| S | <del>Z</del> | S            |
| T | <del>I</del> | T            |
| W | <del>M</del> | W            |
| F | <del>E</del> | F            |

Skills 2 14

NAME: \_\_\_\_\_ DATE: \_\_\_\_\_ 4.2 Activity Page

Directions: For each row, ask students to color the item that is at the beginning green and the item that is at the end red.

|           |  |         |
|-----------|--|---------|
| green<br> |  | red<br> |
| green<br> |  | red<br> |
| green<br> |  | red<br> |
| green<br> |  | red<br> |
| green<br> |  | red<br> |

Skills 2 19



NAME: \_\_\_\_\_ DATE: \_\_\_\_\_ 10.3 Assessment



Directions: Orally segment each word and have students circle each picture.



- 
- 
- 
- 

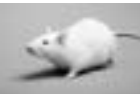

Skills 2 47



Part 2: Blending Score: \_\_\_\_\_



5.   

6.   

7.   

8.   

9.   















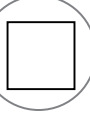



10.   

48 Skills 2

NAME: \_\_\_\_\_ PP.10 Activity Page

DATE: \_\_\_\_\_

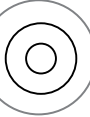
Directions: For each row, have students circle the shape that is the same as the shape on the left and cross out the shapes that are different.







|                                                                                     |                                                                                                |                                                                                                 |                                                                                                 |
|-------------------------------------------------------------------------------------|------------------------------------------------------------------------------------------------|-------------------------------------------------------------------------------------------------|-------------------------------------------------------------------------------------------------|
|   | <del></del> |              | <del></del>  |
|   |             | <del></del>  | <del></del>  |
|   | <del></del> |              | <del></del>  |
|   | <del></del> | <del></del>  |              |
|  |            | <del></del> | <del></del> |

61 Skills 2







NAME: \_\_\_\_\_ PP.11 Activity Page

DATE: \_\_\_\_\_

Directions: For each row, have students circle the shape that is the same as the shape on the left and cross out the shape that is different.

|   |                                                                                     |                                                                                     |
|---|-------------------------------------------------------------------------------------|-------------------------------------------------------------------------------------|
| t | <del>f</del>                                                                        |  |
| i | <del>j</del>                                                                        |  |
| w |  | <del>v</del>                                                                        |
| o | <del>a</del>                                                                        |  |
| d |  | <del>b</del>                                                                        |
| e |  | <del>c</del>                                                                        |















63 Skills 2

|   |                                                                                       |                                                                                       |
|---|---------------------------------------------------------------------------------------|---------------------------------------------------------------------------------------|
| n |  | <del>m</del>                                                                          |
| x | <del>t</del>                                                                          |  |
| u | <del>n</del>                                                                          |  |
| g |  | <del>a</del>                                                                          |
| h | <del>n</del>                                                                          |  |
| f | <del>t</del>                                                                          |  |

64 Skills 2

NAME: \_\_\_\_\_ PP.12 Activity Page  
DATE: \_\_\_\_\_

Directions: For each row, have students color the item that is at the beginning, green, the item that is at the middle yellow, and the item that is at the end red.

|                                                                                             |                                                                                              |                                                                                           |
|---------------------------------------------------------------------------------------------|----------------------------------------------------------------------------------------------|-------------------------------------------------------------------------------------------|
| green<br>  | yellow<br>  | red<br>  |
| green<br>  | yellow<br>  | red<br>  |
| green<br>  | yellow<br>  | red<br>  |
| green<br>  | yellow<br>  | red<br>  |
| green<br> | yellow<br> | red<br> |

Skills 2

65

# Appendix A: More on Sounds and Blending

## VOWEL SOUNDS AND CONSONANT SOUNDS

This program begins with sounds and then teaches the spellings that stand for those sounds. You will need to have a working knowledge of the sounds of English to teach the program effectively. Surprisingly, most speakers of English have only partial knowledge of the sounds of English. We use the sounds of the language every day, but most of us are not actually aware of them unless we have reason to be. When we speak and listen, we focus on meaning, not sounds. If English had a writing system that set down symbols for syllables, there would probably be no need to be aware of individual sounds. However, because our writing system is a way of setting down symbols that stand for individual sounds, it is important that both you and your students be aware of the individual sounds that make up English words.

Linguists refer to single sounds in words as *phonemes*. This is a term used occasionally in instructional materials. With students, however, you may prefer to use the word *sound*. In this program a 44-phoneme classification scheme is used.

English phonemes are divided into two categories, vowel sounds and consonant sounds. The /a/ sound in *at* is a vowel sound; the /t/ sound is a consonant sound. Vowel sounds are made with an open mouth and an unobstructed flow of air. They are the phonemes that tend to get the emphasis when we sing or stretch out a word. By contrast, consonant sounds are made by closing parts of the mouth together, which causes either a partial or a complete blockage of the airflow. Some consonant sounds can be stretched out, but many others are quick sounds that last only a split second and cannot be stretched out.

In the United States, we are in the habit of referring to the letters of the alphabet as “vowels” and “consonants.” Thus, people often say that the letter ‘a’ is a vowel and the letter ‘p’ is a consonant. Many of us were taught that the vowels of English are ‘a,’ ‘e,’ ‘i,’ ‘o,’ ‘u,’—and sometimes ‘y’ and ‘w.’ What we really should say is the letters ‘a,’ ‘e,’ ‘i,’ ‘o,’ ‘u,’—and sometimes ‘y’ and ‘w’—are used to stand for vowel sounds. This tendency to speak as if vowels and consonants were letters, as opposed to sounds, leads to confusion and misunderstanding.

In this program, the terms *vowel* and *consonant* refer to sounds rather than letters. To avoid ambiguity and make it clear, this program generally avoids the ambiguous nouns *vowel* and *consonant*, preferring the more specific noun phrases *vowel sound* and *consonant sound*.

## THE CONSONANT SOUNDS OF ENGLISH

Table 1 shows the consonant sounds of English, each with its basic code spelling and a sample word. The basic code spelling is the most common, or least ambiguous, spelling for a sound. It is also the first spelling for the sound taught in this program.

| <b>Phoneme</b> | <b>Basic Code Spelling(s)</b> | <b>Sample Word(s)</b> |
|----------------|-------------------------------|-----------------------|
| /b/            | 'b'                           | <b>bib</b>            |
| /ch/           | 'ch'                          | <b>chip</b>           |
| /d/            | 'd'                           | <b>dad</b>            |
| /f/            | 'f'                           | <b>fish</b>           |
| /g/            | 'g'                           | <b>gig</b>            |
| /h/            | 'h'                           | <b>hip</b>            |
| /j/            | 'j'                           | <b>jam</b>            |
| /k/            | 'c', 'k'                      | <b>cab, kit</b>       |
| /l/            | 'l'                           | <b>lip</b>            |
| /m/            | 'm'                           | <b>mom</b>            |
| /n/            | 'n'                           | <b>nun</b>            |
| /ng/           | 'ng'                          | <b>sing</b>           |
| /p/            | 'p'                           | <b>pop</b>            |
| /qu/           | 'qu'                          | <b>quit</b>           |
| /r/            | 'r'                           | <b>red</b>            |
| /s/            | 's'                           | <b>sis</b>            |
| /sh/           | 'sh'                          | <b>shush</b>          |
| /t/            | 't'                           | <b>tot</b>            |
| /th/           | 'th'                          | <b>thin</b>           |
| / <u>th</u> /  | 'th'                          | <b>them</b>           |
| /v/            | 'v'                           | <b>vet</b>            |
| /w/            | 'w'                           | <b>win</b>            |
| /x/            | 'x'                           | <b>box</b>            |
| /y/            | 'y'                           | <b>yes</b>            |
| /z/            | 'z'                           | <b>zip</b>            |
| /zh/           | (none)                        | <b>treasure</b>       |

As you study this table, notice the sounds are written inside slashes. This notation makes it possible to distinguish sounds from spellings, which are written inside single quotation marks. These styles are used throughout the instructional materials: /m/ refers to the sound “mmm”; ‘m’ refers to the most common way to spell that sound.

All of these consonant sounds are taught in Kindergarten, with the exception of /zh/ as in *treasure*, which is very rare and spelled inconsistently. It should be pointed out that two of the sounds listed in Table 1 are actually **sound combinations** rather than single sounds:

- /x/ is really /k/ + /s/
- /qu/ is really /k/ + /w/

However, these are taught in the program as if they were single sounds. The first, /x/, is so taught because it is usually written with the letter ‘x,’ and the second, /qu/, because it is almost always written with the letters ‘qu.’ Because these sound combinations are usually written with indivisible spellings, they are taught as if they are indivisible sounds.

### Parts of the Mouth

Diagram 1 shows the parts of the mouth involved in producing the consonant sounds of English.

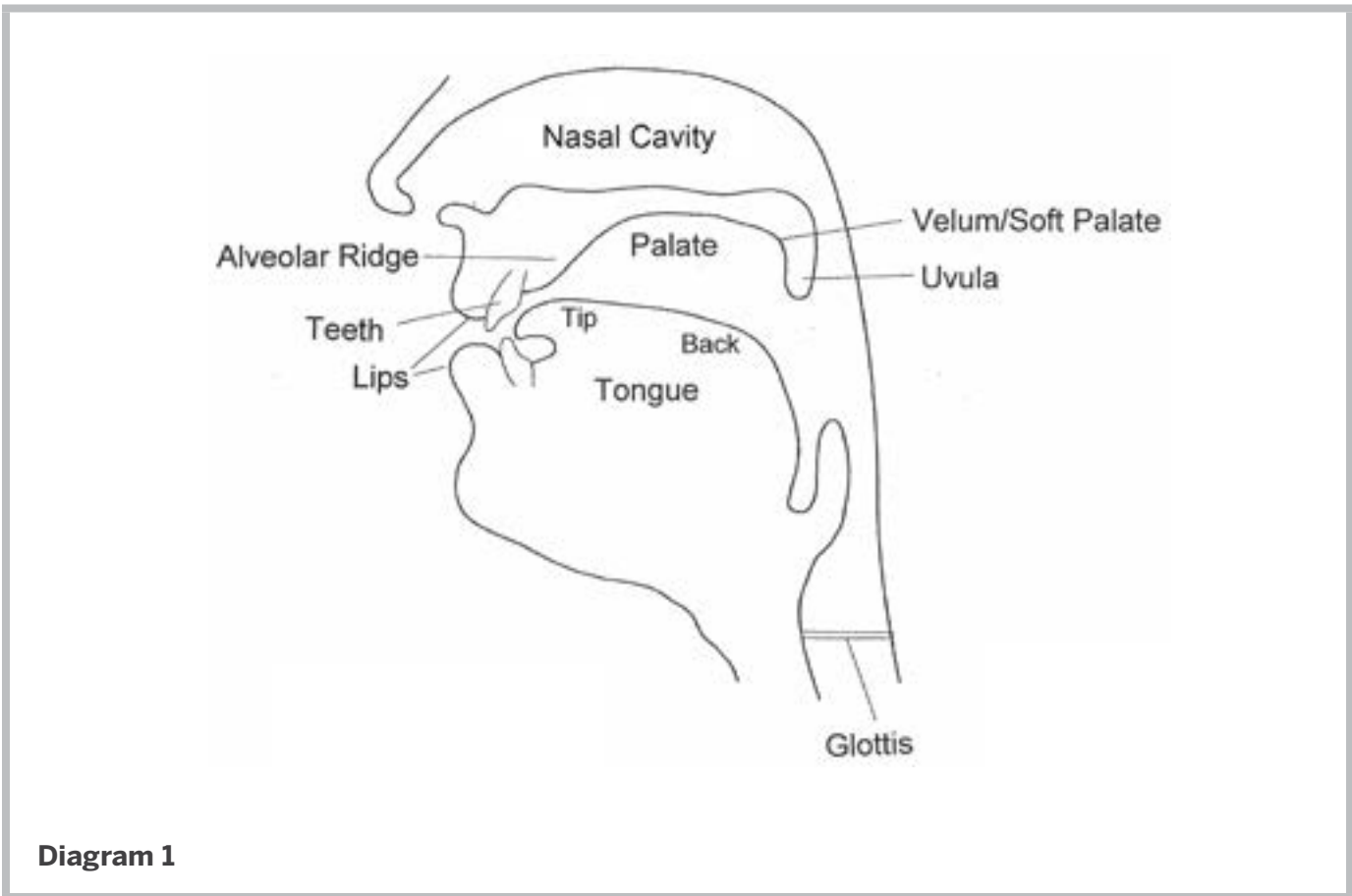

**Diagram 1**



Most of the parts of the mouth in this diagram will be familiar. A few may not be:

- The alveolar ridge is the part of the roof of the mouth right behind the front teeth. When you run your tongue from the upper front teeth back, you can feel it as a bump.
- The palate is the hard central part of the roof of the mouth.
- The velum, or soft palate, is the rear roof of the mouth. It is softer than the hard palate. You can feel the difference between the hard and soft palate when you run your tongue along the roof of the mouth backwards as far as you can.
- The uvula is the dangly set of muscles that hang from the velum.
- The glottis is the space between the vocal cords inside the voice box.

These terms are frequently used in the paragraphs that follow to describe the point of articulation for the sounds of the English language.

### **Voiced and Unvoiced Sounds**

Some of the consonant sounds listed in Table 1 are related to one another because they are made with the same parts of the mouth, or with the mouth in the same position. For example, /z/ and /s/ are both made by placing the tongue just behind the upper teeth, on the alveolar ridge. The only difference is that /z/ is buzzier sounding because the vocal chords vibrate when you make this sound. Linguists say that /z/ is *voiced* and /s/ is *unvoiced*, or *voiceless*. Table 2 shows the consonant sounds of English. It also provides information about which parts of the mouth are involved in making each consonant sound, which consonants are voiced, and which are unvoiced.

**Table 2**

| <b>Voiced sound</b> | <b>Unvoiced sound</b> | <b>Place of articulation</b>    | <b>Manner of articulation</b> | <b>Air through nose?</b> |
|---------------------|-----------------------|---------------------------------|-------------------------------|--------------------------|
| <b>/b/</b>          | <b>/p/</b>            | both lips                       | plosive                       | no                       |
| <b>/d/</b>          | <b>/t/</b>            | alveolar ridge                  | plosive                       | no                       |
| <b>/g/</b>          | <b>/k/</b>            | velum/soft palate               | plosive                       | no                       |
| <b>/j/</b>          | <b>/ch/</b>           | alveolar ridge/palate           | affricate                     | no                       |
| <b>/zh/</b>         | <b>/sh/</b>           | alveolar ridge/palate           | fricative                     | no                       |
| <b>/z/</b>          | <b>/s/</b>            | alveolar ridge                  | fricative                     | no                       |
| <b>/v/</b>          | <b>/f/</b>            | lower lip and upper teeth       | fricative                     | no                       |
| <b>/th/</b>         | <b>/th/</b>           | tongue between teeth            | fricative                     | no                       |
|                     | <b>/h/</b>            | glottis                         | fricative                     | no                       |
| <b>/w/</b>          |                       | both lips and velum/soft palate | fricative                     | no                       |
| <b>/m/</b>          |                       | both lips                       | continuous (nasal)            | yes                      |
| <b>/n/</b>          |                       | alveolar ridge                  | continuous (nasal)            | yes                      |
| <b>/ng/</b>         |                       | velum/soft palate               | continuous (nasal)            | yes                      |
| <b>/l/</b>          |                       | alveolar ridge                  | continuous (non-nasal)        | no                       |
| <b>/r/</b>          |                       | alveolar ridge/palate           | continuous (non-nasal)        | no                       |
| <b>/y/</b>          |                       | palate                          | continuous (non-nasal)        | no                       |

It is important for you to be able to hear the difference between the voiced and unvoiced sounds in the first eight rows of Table 2. To do so, you may find it helpful to alternately pronounce voiced and unvoiced sounds while pressing your fingertips against your ears and pressing your palms against your cheeks. This makes it easier to hear—and feel—the voicing.

The voicing is easiest to hear for the fricative pairs (/zh/ and /sh/, /z/ and /s/, /v/ and /f/, voiced /th/ and voiceless /th/) because these sounds can be stretched out and continued for several seconds. Once you can hear the difference between these pairs of sounds, try to hear the difference between the affricate pair, /j/ and /ch/, and the plosive pairs (/b/ and /p/, /d/ and /t/, /g/ and /k/). The voicing for the voiced plosive sounds /b/, /d/, /g/, and /j/ is harder to hear because these sounds are made with a little puff of air and cannot be stretched out. This means you have only a split second to hear the voicing.

The other information in Table 2 is less essential, but it may be useful to you in various ways. Some of the terms require explanation.

### **How the Consonant Sounds Are Made**

The sounds are grouped into four categories: plosives, affricates, fricatives, and continuous sounds.

The word *plosive* comes from the same root as *explosive*. Plosive sounds are made with a short burst of air, like a short explosion bursting out of the mouth. They do not last long and cannot be stretched out.

As Table 2 shows, there are three pairs of plosives, each of which is distinguished by the presence or absence of voicing.

- The sounds /b/ and /p/ are made with both lips. The lips are pressed together; air is held back behind the lips and then suddenly released.
- The sounds /d/ and /t/ are made by pressing the tip of the tongue against the alveolar ridge, which is the part of the mouth just behind your upper teeth (see Diagram 1). Again, air is held back behind the barrier this forms and then suddenly released.
- The sounds /g/ and /k/ are made by pressing the back of the tongue against the velum, or soft palate, which is farther back in the mouth, behind the alveolar ridge. Air is held back and suddenly released.

Because the plosives are difficult to pronounce in isolation, it is tempting to add a short vowel sound after the consonant sound. Thus there is a tendency to pronounce /b/ like this: /buh/. When you teach these sounds, make an effort to keep the sounds as clipped as possible. They should sound more like a burst of air and less like /buh/, /kuh/, /guh/, etc. Be aware that there is a kind of trade-off at work here: if you add a vowel sound after the plosive consonant, your pronunciation is less accurate but it will probably be easier for students to hear. On the other hand, if you eliminate the vowel sound and pronounce only the clipped consonant sound, your pronunciation becomes more accurate but will probably be harder for students to hear. There is no perfect solution, but it is good

to be aware of the problem. You might even find it useful to talk about the problem with students, explaining that it is hard to make a consonant sound without adding a little bit of a vowel sound.

The affricates form a middle group between the plosive sounds and the fricatives. These sounds begin like plosives, with a burst of air, but they end like fricatives, as air forced out creates friction.

- The sounds /j/ and /ch/ are made by pressing the rim of the tongue against the alveolar ridge/palate. Again, air is held back and then suddenly released with friction.

The word *fricative* comes from the same root as *friction*. When you make a fricative sound, you generate friction by forcing air out of a narrowed mouth. Unlike plosives, fricatives can be stretched out and pronounced continuously for several seconds.

As Table 2 shows, there are four pairs of fricatives, each of which is distinguished by the presence or absence of voicing and two additional fricatives.

- The sounds /zh/ and /sh/ are made by placing the rim of the tongue next to the alveolar ridge/palate and forcing air noisily through the space between. The first is voiced; the second is not.
- The sounds /z/ and /s/ are made by placing the tip of the tongue next to the alveolar ridge and forcing air noisily through the space between. The first is voiced; the second is not.
- The sounds /v/ and /f/ are made by placing the upper teeth on the lower lip and forcing air noisily through the space between. The first is voiced; the second is not.
- The sounds /th/ and /th/ are made by placing the tip of the tongue between the upper and lower teeth and forcing air noisily through the space between. The first is voiced; the second is not. A useful pair to help you hear the difference is *either/ether*.
- The sound /h/ is a fricative that is hard to feel. The vocal folds in the voice box are opened slightly and air is forced noisily through the space between the folds.
- The sound /w/ is another challenging fricative sound. The lips are rounded, while the back of the tongue is raised and the air is pushed through the space between the tongue and the velum, or soft palate.

Continuous sounds can be grouped into two categories, nasal and non-nasal. Nasal sounds are made by forcing air out through the nose. The velum, or soft palate, is lowered so air can flow through the nasal cavity. You can locate the velum by looking into your mouth in a mirror. The uvula can be seen hanging down in the back of your throat. It is an extension of the velum.

- The sound /m/ is made by pressing both lips together and forcing air out through the nose.
- The sound /n/ is made by pressing the tip of the tongue against the alveolar ridge and forcing air out through the nose.
- The sound /ng/ is made by pressing the back of the tongue against the velum, or soft palate, and forcing air out through the nose. (Note that this is a single sound and not a combination of /n/ + /g/.)

Nasals can be stretched out and said continuously in a way that the stop sounds cannot. However, because these nasal sounds require movement of air through the nose, they can be hard to pronounce if your nose is stuffy from a cold.

The last three consonant sounds are non-nasal sounds. For these non-nasals, the velum, or soft palate, is raised so air flows through the oral cavity instead of the nasal cavity.

- The sound /l/ is made with the tip of the tongue pressed against the alveolar ridge and air passing through the mouth cavity with minimal friction.
- The sound /r/ is made with the tip of the tongue pressed just behind the alveolar ridge and air passing through the mouth cavity with minimal friction.
- The sound /y/ is made with the tongue pressed against the palate and air passing through the mouth cavity with minimal friction.

**Please note:** It is not necessary that you understand all of the linguistic terms and information provided here. You can teach the program successfully if you can do the following:

- Hear, speak, isolate, and distinguish the consonant sounds.
- Distinguish voiced from unvoiced sounds.

It is recommended that you not attempt to teach terms like *fricative* and *plosive* to students. However, some of the information in Table 2 may be helpful to you, either as you prepare to teach the program or as a reference source later in the year. In general, the more you know about sounds and how they are made, the better you will be at teaching the program. A knowledge of English sounds and the various places of articulation can be useful in many ways. For example, if you understand that /d/ and /t/ are made with the same parts of the mouth and differ only in voicing, you may be able to understand why a student spells *dark* as *tark*. The student is confusing two very similar sounds. Likewise, you will be better able to explain why the letters 'ed' are often pronounced /t/, as in *ripped* and *fished*. Again, this has to do with similarities between /d/ and /t/, and with voicing. There are many interesting patterns in English spelling that can only be fully understood if you know a little linguistics.

## Spelling Alternatives for Consonant Sounds

Most of the consonant sounds in English can be spelled at least two different ways. A few can be spelled several different ways. Table 3 shows some spelling alternatives for consonant sounds.

**Table 3**

| Phoneme | Basic Code Spelling | Advanced Code Spellings      | Example Words                                                       |
|---------|---------------------|------------------------------|---------------------------------------------------------------------|
| /b/     | 'b'                 | 'bb'                         | <b>bat, ebb</b>                                                     |
| /ch/    | 'ch'                | 'tch,'t'                     | <b>chop, watch, future</b>                                          |
| /d/     | 'd'                 | 'dd,'ed'                     | mad <b>, rudder, played</b>                                         |
| /f/     | 'f'                 | 'ff,'ph,'gh'                 | <b>fox, stuff, phone, rough</b>                                     |
| /g/     | 'g'                 | 'gg,'gu,'gh,'gue'            | <b>get, egg, guess, ghost, vague</b>                                |
| /h/     | 'h'                 | 'wh'                         | <b>hat, who</b>                                                     |
| /j/     | 'j'                 | 'g,'dge,'dg,'ge,'d'          | <b>jump, giant, judge, judging, barge, education</b>                |
| /k/     | 'c,'k'              | 'ck,'cc,'ch'                 | <b>cat, kit, rock, raccoon, school</b>                              |
| /l/     | 'l'                 | 'll'                         | <b>lip, bell</b>                                                    |
| /m/     | 'm'                 | 'mm,'mn,'mb'                 | <b>mat, hammer, hymn, lamb</b>                                      |
| /n/     | 'n'                 | 'nn,'kn,'gn'                 | <b>net, runner, knot, gnat</b>                                      |
| /ng/    | 'ng'                | 'n'                          | <b>thing, think</b>                                                 |
| /p/     | 'p'                 | 'pp'                         | <b>pit, pepper</b>                                                  |
| /qu/    | 'qu'                |                              | <b>quit</b>                                                         |
| /r/     | 'r'                 | 'rr,'wr,'rh'                 | <b>red, squirrel, wrong, rhombus</b>                                |
| /s/     | 's'                 | 'ss,'c,'sc,'st,'ce,'se'      | <b>sit, dress, city, science, whistle, prince, rinse</b>            |
| /sh/    | 'sh'                | 'ss,'s,'ch,'ssi,'si,'ti,'ci' | <b>ship, assure, sure, chef, session, tension, Martian, Grecian</b> |
| /t/     | 't'                 | 'tt,'ed,'bt'                 | <b>top, mitt, walked, doubt</b>                                     |
| /th/    | 'th'                |                              | <b>thin</b>                                                         |
| /th/    | 'th'                | 'the'                        | <b>them, bathe</b>                                                  |
| /v/     | 'v'                 | 've'                         | <b>vet, valve</b>                                                   |
| /w/     | 'w'                 | 'wh'                         | <b>wet, when</b>                                                    |
| /x/     | 'x'                 |                              | <b>tax</b>                                                          |
| /y/     | 'y'                 |                              | <b>yes</b>                                                          |
| /z/     | 'z'                 | 'zz'                         | <b>zip, buzz</b>                                                    |
| /zh/    | (none)              | 'ge,'j,'s'                   | <b>garage, Jacques, treasure</b>                                    |

Notice consonant sounds can be written with single letters or with letter teams. When two letters work together to stand for a single sound, as in *thin* or *fish*, the two letters that stand for one sound are called a *digraph*. One of the complexities of reading English is that students must be able to take words made up of single-letter spellings (monographs) and double-letter spellings (digraphs) and rapidly distinguish the letters that stand for sounds individually from those working together as a letter team or digraph. For example, to successfully decode the word *graph*, students have to determine that the letters 'g,' 'r,' and 'a' each stand for one sound, while the last two letters, 'p' and 'h' work together as a letter team, to stand for a single sound, /f/. This requires a fairly complicated "chunking" operation.

Diagram 2 shows the relationships between consonant sounds (on the right) and consonant spellings (on the left).

# CONSONANTS

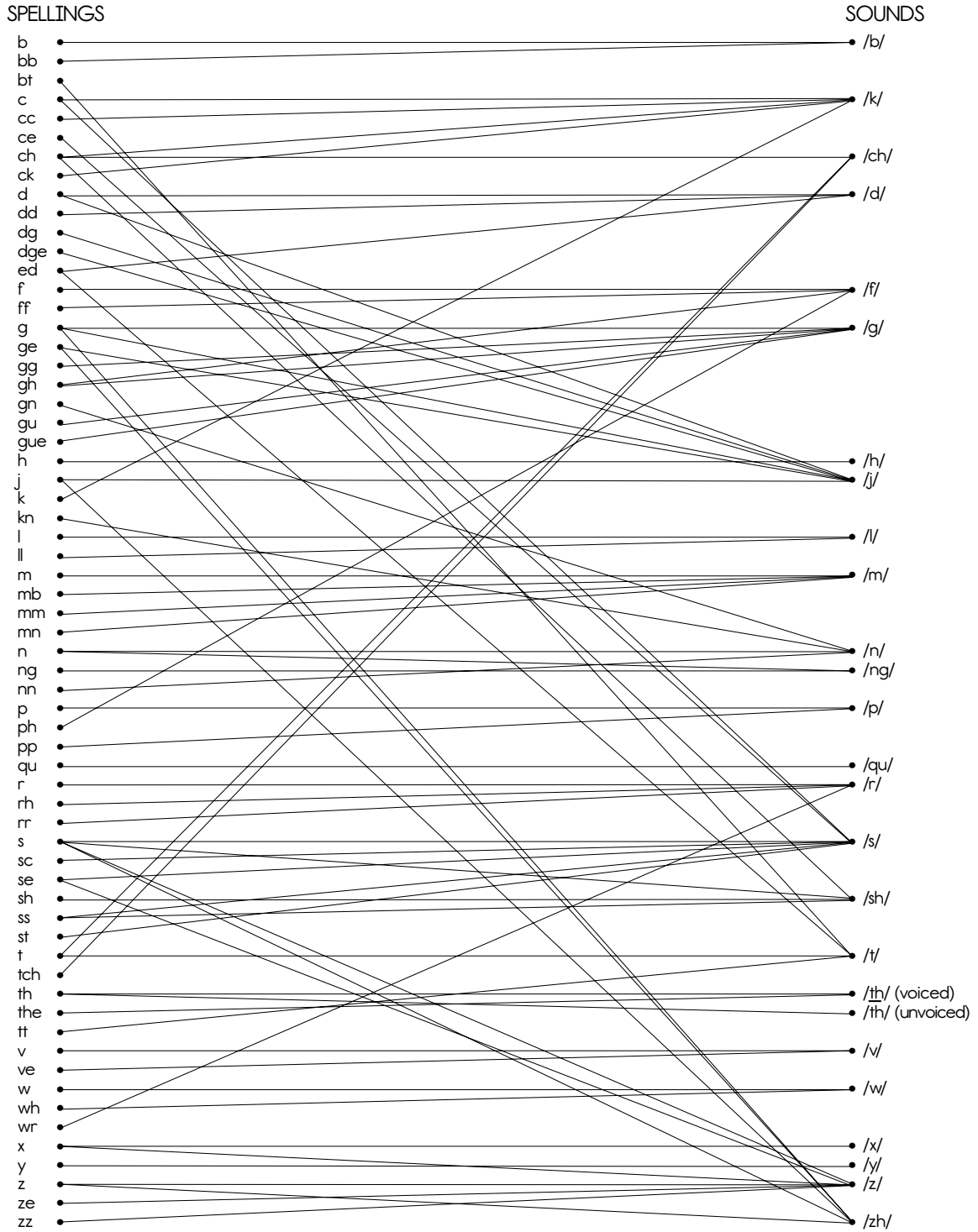

Diagram 2



You can see that the relationship between English consonant sounds and the spellings used to represent those sounds is not simple. If every consonant sound in the language were spelled only one way, all of the lines on Diagram 2 would run straight across; there would be no diagonal lines on the chart. As you can see, that is not the case.

You can see that the sound /j/ on the right side of the chart is connected to six different spellings on the left side of the chart. That is to say, the sound /j/ can be spelled six different ways: with 'j' as in *jump*, 'g' as in *gem*, 'ge' as in *large*, 'dge' as in *judge*, 'dg' as in *judging*, and 'd' as in *education*. This is an example of sound-to-spelling complexity. One sound can be spelled several different ways.

There are also spelling-to-sound complexities. Consider the spelling 'c.' It is connected with two sounds on the right side of the chart: the connecting lines show that 'c' can be sounded /k/ ("hard") as in *cat* or /s/ ("soft") as in *cent*.

No attempt is made to introduce all of this complexity in Kindergarten. Rather, the program shields Kindergarten students from most of this complexity so they can learn the most common letter-sound correspondences without interference from the less common ones. The Kindergarten lessons introduce the most common spelling for each consonant sound, except /zh/. They also introduce 'c,' 'k,' and 'ck' as spellings for /k/, 's' as a spelling for /z/, and the double-letter spellings (e.g., 'ff' for /f/, 'ss' for /s/, 'll' for /l/). Other spelling alternatives for consonant sounds are taught in Grade 1.

---

## THE VOWEL SOUNDS OF ENGLISH

Consonant sounds are made by obstructing the air flow out of the mouth in one way or another. Vowel sounds are made with an open mouth and an unobstructed flow of air.

Table 4 shows the vowel sounds of English, along with the basic code spelling for each sound and a sample word containing that spelling. The basic code spelling is the first spelling taught. It is usually the most common spelling for the sound, though in some cases it is the least ambiguous of several common spellings. (In other words, there may be other spellings just as common or even a little more common, but those spellings can be pronounced several different ways and are not the best choices for a basic code spelling.) The bolded basic code spellings listed in the chart are taught in Kindergarten; the other spellings are taught in subsequent grades.

Notice this chart is organized around the phonemes, not the letters of the alphabet. Whenever vowels or vowel sounds are discussed we are referring to this set of nineteen sounds—not the seven letters 'a,' 'e,' 'i,' 'o,' 'u,' and sometimes 'y' and 'w.' Those seven letters are the letters most commonly used, singly and in combinations, to represent the vowel sounds. They are not vowels themselves, in spite of what most of us have been taught.

**Table 4**

| <b>Phoneme</b> | <b>Basic Code Spelling</b> | <b>Sample Word</b> |
|----------------|----------------------------|--------------------|
| /a/            | 'a'                        | at                 |
| /ae/           | 'a_e'                      | ate                |
| /ar/           | 'ar'                       | car                |
| /aw/           | 'aw'                       | paw                |
| /e/            | 'e'                        | bet                |
| /ee/           | 'ee'                       | teen               |
| /er/           | 'er'                       | her                |
| /i/            | 'i'                        | big                |
| /ie/           | 'i_e'                      | time               |
| /o/            | 'o'                        | cot                |
| /oe/           | 'o_e'                      | note               |
| /oi/           | 'oi'                       | coin               |
| /oo/           | 'oo'                       | soon               |
| /oo/           | 'oo'                       | book               |
| /or/           | 'or'                       | for                |
| /ou/           | 'ou'                       | out                |
| /u/            | 'u'                        | bun                |
| /ue/           | 'u_e'                      | cute               |
| /ə/            | 'a'                        | about              |
| /ə/ + /l/      | 'al'                       | animal             |

Differences among the vowel sounds are determined mostly by the position of the tongue inside the mouth, the openness of the mouth (i.e., the position of the jaw), and the degree of rounding of the lips.

Linguists divide vowels into two groups: so-called simple vowels and diphthongs. The simple vowels involve a steady mouth position—a position that does not change during the articulation of the sound. The sounds /ee/, /i/, /a/, /e/, /u/, /o/, /aw/, /oo/ as in *book*, and /oo/ as in *soon* are simple vowels. When pronouncing a diphthong, the mouth moves from one articulatory position at the beginning of the sound to another at the end. The sounds /ae/, /ie/, /ue/, /oe/, /ou/, /oi/, /er/, /or/, and /ar/ are diphthongs. Students do not need to be aware of the distinction between simple vowels and diphthongs (in fact it is recommended that you not teach this), but it may be useful for you to be aware of it.

Every word in English must contain a vowel sound. Most words also contain consonant sounds, but the vowel is the required element.

Every syllable in English contains one (and only one) vowel sound. A syllable may contain no consonant sounds, or it may contain several. However, it always contains exactly one vowel sound. The number of vowel sounds in a word determines the number of syllables: a word with one vowel sound is a one-syllable word. A word with two vowel sounds is a two-syllable word, and so on.

All of the vowel sounds can be stretched out, at least a little. When we need to call Sandy to dinner, we yell her name and stretch out the vowel sounds: “Saaaaaandeeeee!” The vowel sounds are also the parts of the word that we emphasize when singing. You can sing “Happy Birthday” with just the vowels and it still sounds recognizable. Try it: “/a/ ... /ee/ ... /er/ ... /ae/ ... /oo/ ... /oo/.” On the other hand, if you sing the same song with only the consonant sounds, it does not sound like anything at all: “/h/ ... /p/ ... /b/ ... /th/ ... /d/ ... /t/ ...” This is why consonants are called consonants. The word *consonant* comes from the Latin verb *consonare*, meaning “to sound with.” Many consonant sounds have to be *sounded with* a vowel to be heard distinctly.

The sounds /er/, /ar/, and /or/ are treated as vowel diphthongs in this program because /r/ has certain vowel-like qualities that make it combine with the preceding vowel sound. This is one area where this program may differ from what you learned in school and what you have taught in previous years. The r-controlled vowel sounds are discussed in more detail when those sounds are taught.

The sound /aw/ is very close to the sound /o/, and in some regions of the United States /aw/ and /o/ have “fallen together” to such a degree that the two are more or less indistinguishable. In other parts of the country, however, these two sounds are still distinct. Try pronouncing *cot* and *caught*, *knotty* and *naughty*, and see if you can hear a difference. If you cannot hear a difference, these sounds may have fallen together in your region. Before you decide, you might try looking in a mirror: the /aw/ sound is made with the lips more tightly rounded and the /o/ sound with less rounded lips. The sound /aw/ is not taught in Kindergarten. The relationship between /o/ and /aw/ is discussed when the /aw/ sound is first taught, in Grade 1.

Note the sound /oo/ is not the same as the sound /ue/. Compare *food* and *feud*. From a strictly phonemic point of view, /ue/ must be seen as a combination of two sounds: /y/ + /oo/. However, it is taught in this program as if it were a single sound (a diphthong).

The vowel sounds /a/, /e/, /i/, /o/, and /u/ have traditionally been called the “short vowels,” while /ae/, /ee/, /ie/, /oe/, and /ue/ have been tagged as the “long vowels.” There is some controversy about whether these categories are defensible. Many linguists think the short/long distinction is dubious, and some reading experts think it may be confusing to students, since /ae/ does not necessarily last longer than /a/. You can say the “short” /a/ sound in a stretched-out fashion so it lasts several seconds. Imagine a mother yelling across a field to her son, whose name is Adam: “Aaaaaa–dum!” Is that first sound a “short” vowel sound or a “long” vowel sound?

On the other hand, “long” and “short” are widely used terms most teachers know, and there do not appear to be competing terms that can be easily substituted. Also, there are certain interesting relationships between the “short” and “long” vowels that are more difficult to describe if the terms “short” and “long” are not available. For example, in the pair *photo/photography*, the second vowel sound is /oe/ (also known as long ‘o’) in the base form and /o/ (a.k.a. “short” ‘o’) in the derivative form, but both are written ‘o.’ Likewise, in the pair *bath/bathe*, there is a relationship between /a/ (a.k.a. “short” ‘a’) and /ae/ (a.k.a. “long” ‘a’). The root word appears in two slightly different forms, one of which has long ‘a’ /ae/ while the other has the “short” ‘a’ /a/. Without the terms “long” and “short” it would be hard to talk about such systematic relationships. The terms are also useful when describing spelling patterns; for example, one can say that the spelling ‘ss’ is usually used after the short vowels. In these materials the terms “long vowels” and “short vowels” are used less than is usual, but they are used occasionally when there is a warrant for doing so, for example, when discussing spelling patterns and when it is necessary to contrast the two sets of sounds—/a/, /e/, /i/, /o/, /u/ vs. /ae/, /ee/, /ie/, /oe/, /ue/.

## Spelling Alternatives for Vowel Sounds

Most vowel sounds can be spelled in several different ways. Some of the most common ways are shown in Table 5.

| Phoneme   | Basic Code Spelling | Advanced Code Spellings                                    | Example Words                                                         |
|-----------|---------------------|------------------------------------------------------------|-----------------------------------------------------------------------|
| /a/       | 'a'                 |                                                            | cat                                                                   |
| /æ/       | 'a_e'               | 'a', 'ai', 'ay', 'ei', 'ey', 'eigh', 'ea', 'aigh'          | date, baby, rain, tray, vein, prey, eight, steak, straight            |
| /ar/      | 'ar'                |                                                            | arm                                                                   |
| /aw/      | 'aw'                | 'au', 'ough', 'augh', 'al'                                 | paw, pause, ought, naughty, wall                                      |
| /e/       | 'e'                 | 'ea', 'ai', 'ay', 'a', 'ie'                                | bed, head, said, says, many, friend                                   |
| /ee/      | 'ee'                | 'e', 'ea', 'y', 'e_e', 'ey', 'ie', 'i', 'ei'               | bee, me, meat, bunny, scene, key, chief, variation, receive           |
| /er/      | 'er'                | 'ir', 'ur', 'or', 'ar', 'ear', 'urr', 'our'                | her, fir, fur, work, dollar, earth, hurry, courage                    |
| /i/       | 'i'                 | 'y', 'ui', 'i_e'                                           | sit, gym, build, give                                                 |
| /ie/      | 'i_e'               | 'i', 'igh', 'ie', 'y', 'y_e', 'ye', 'uy'                   | fine, find, high, pie, my, style, bye, guy                            |
| /o/       | 'o'                 | 'a', 'wa'                                                  | hot, lava, water                                                      |
| /oe/      | 'o_e'               | 'o', 'oe', 'ow', 'oa'                                      | rope, no, toe, snow, boat                                             |
| /oi/      | 'oi'                | 'oy'                                                       | oil, boy                                                              |
| /oo/      | 'oo'                | 'o_e', 'u', 'u_e', 'ue', 'ew', 'o', 'ou', 'ui', 'eu', 'oe' | soon, approve, super, tune, blue, new, do, soup, fruit, neutral, shoe |
| /oo/      | 'oo'                | 'u', 'oul'                                                 | wood, put, could                                                      |
| /ou/      | 'ou'                | 'ow', 'ough'                                               | out, now, bough                                                       |
| /or/      | 'or'                | 'ore', 'our', 'oor', 'oar', 'ar'                           | for, bore, four, door, soar, award                                    |
| /u/       | 'u'                 | 'o', 'ou', 'o_e', 'e'                                      | but, among, touch, come, the                                          |
| /ue/      | 'u_e'               | 'u', 'ue', 'ew'                                            | cute, pupil, hue, few                                                 |
| /ə/       | 'a'                 | 'e'                                                        | about, debate                                                         |
| /ə/ + /l/ | 'al'                | 'le', 'el', 'ul', 'il'                                     | animal, apple, travel, awful, pencil                                  |

Notice that there are only two vowel sounds that are almost always spelled the same way: the sound /a/ as in *cat* and the sound /ar/ as in *arm*. All of the other vowels can be spelled at least two different ways, and several of them are spelled many different ways.

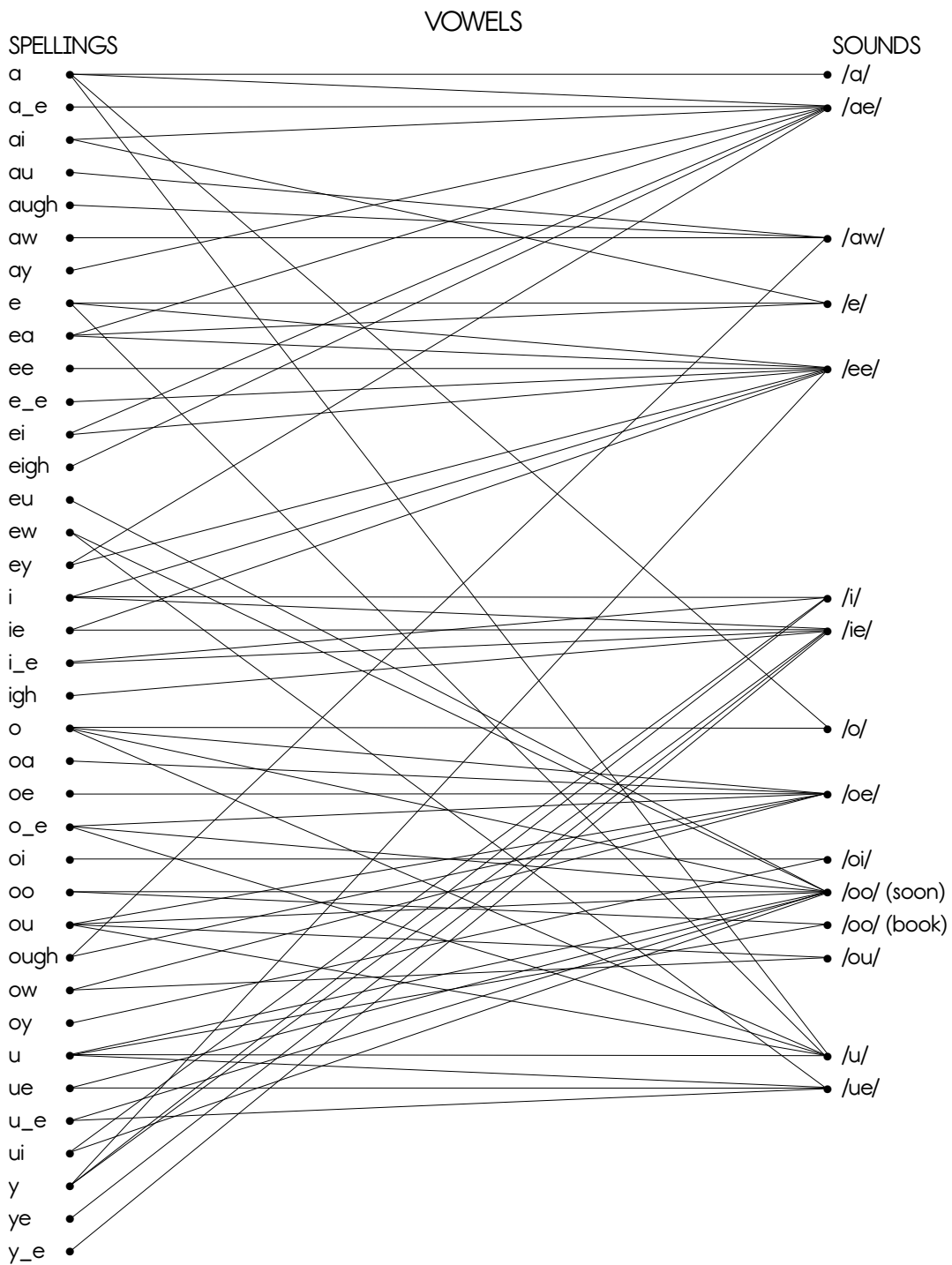

**Diagram 3**

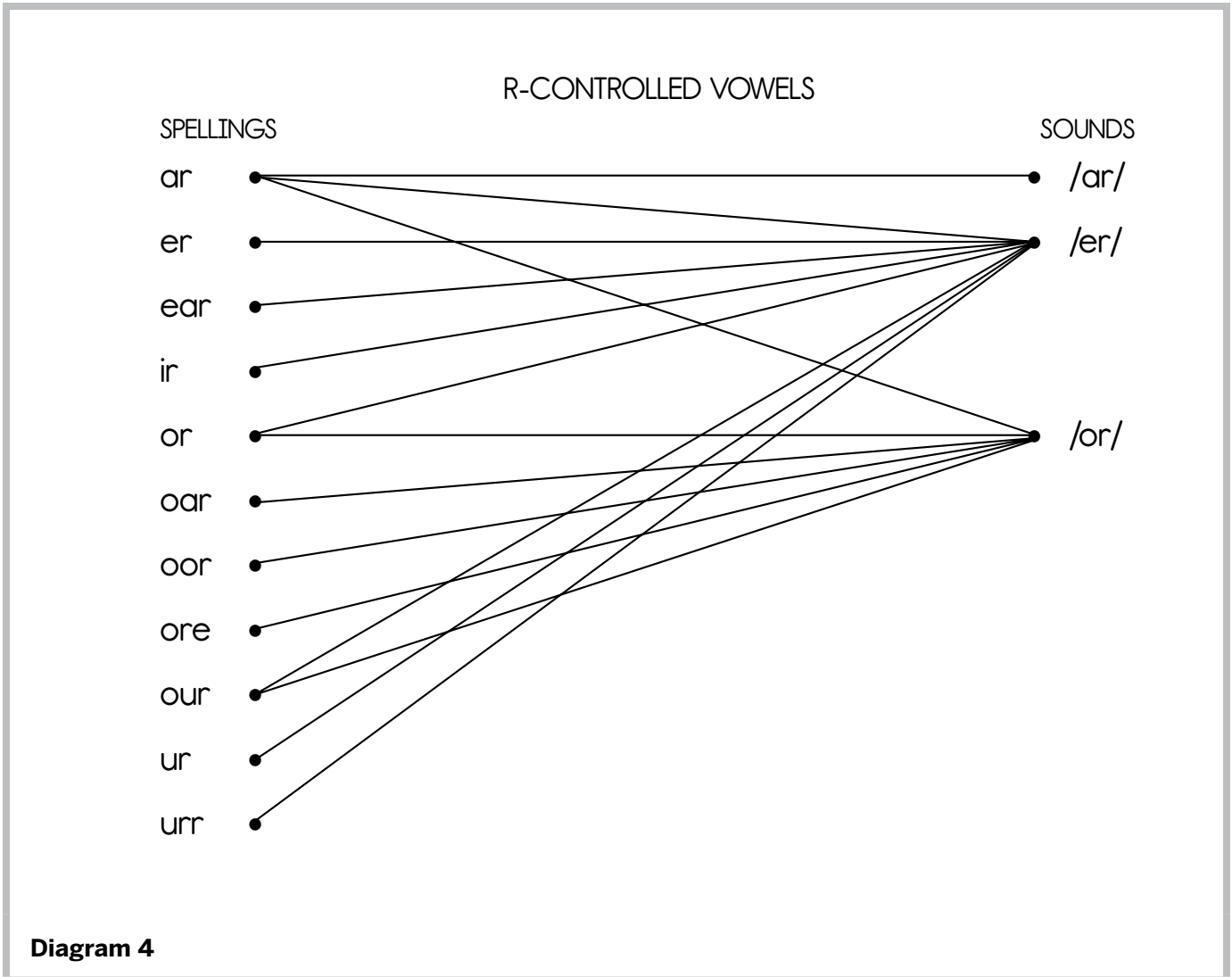

Diagram 3 shows the complex relationships between vowel sounds (on the right) and vowel spellings (on the left). In a simple spelling system, where every sound is written one way, the lines in the diagram would all run straight across, with no diagonals. What you see here, on the other hand, is that many of the sounds on the right can be written with several of the spellings on the left. For example, the sound /ae/ can be spelled 'a' as in *table*, 'a\_e' as in *gate*, 'ai' as in *wait*, 'ay' as in *say*, 'ea' as in *great*, 'ei' as in *vein*, and 'eigh' as in *weight*. What this means in practice is the sound /ae/ is hard to spell.

There are also problems moving from spelling to sound. Many of the spellings on the left can be pronounced several different ways. For example, the 'a' spelling can be pronounced /a/ as in *apple*, /ae/ as in *able*, /o/ as in *lava*, and /ə/ as in *about*. This means that 'a' is a tricky spelling that can be difficult to pronounce with confidence.

Vowel sounds and their spellings are the trickiest part of the English spelling code. There are a great many spellings students need to learn, and many of these spellings are “shared” by two or more sounds, which means they are sounded differently in different words. Thus, vowel sounds tend to be hard to spell, and vowel spellings can be hard to pronounce during oral reading.

The r-controlled vowels have been depicted in Diagram 4. Again, you can see some complicated relationships between sounds and spellings, and vice versa.

No attempt is made to introduce all of the vowel spellings shown in Table 5 in Kindergarten. On the contrary, great pains have been taken to avoid some of the less common and/or more ambiguous vowel spellings during the early phases of instruction. For the most part, the challenging task of mastering English vowel spellings is saved for Grades 1 and 2. A goal for Grade 1 is to teach students to recognize the most common vowel spellings while reading. A goal for Grade 2 and beyond is to teach students to begin to use the correct spellings when writing.

---

## BLENDING

As noted above, this program teaches blending (sometimes called *sounding out*) as the primary strategy for reading. It de-emphasizes, and in fact, discourages the teaching of other cueing strategies you may have been encouraged to teach along with phonics, including the use of context clues, spelling analogies, and pictures to guess how a word is pronounced. Context does have a role to play in reading, but it is a secondary role, and it should not be emphasized at the outset. The same is true of reading words by spelling analogy (e.g., reading *fable* by analogy with *table*). This is an important skill but it needs to come later, after blending and the basic letter-sound correspondences have been taught.

Blending is an essential skill for reading instruction. Where there is no blending, there is no real reading. There may be story retelling and whole-word recognition, but this is not really reading. A student who “reads” books from memory and “reads” words by remembering them as wholes has not grasped the essence of our writing system. Such a student is not really reading and cannot generalize his knowledge of specific words to allow him to read new words. He or she will be helpless when confronted with new words or new stories.

The Kindergarten curriculum has been set up to maximize the chances that students will learn to read by blending. The first two units of Kindergarten contain a very carefully scaffolded buildup to oral blending. Units 3–5 have been carefully constructed to focus on blending sounds that are written with single letters. During these early units, ambiguous spellings are avoided and letters are always sounded out one way. Digraphs are avoided so students can learn to blend without the additional difficulty of chunking words into single- and double-letter spellings. Letter names are avoided because the letter names can interfere with blending. Tricky Words are avoided because they contain some parts that cannot be pronounced correctly via blending. In short, everything has been arranged to maximize the chances that students will learn to blend and will have many opportunities to practice error-free blending. If that can be accomplished, the chances are very high that the student will go on to become a good reader.



## Two Ways to Teach Blending

There are two slightly different ways of teaching blending. One way is called final blending and one is called sequential blending.

When final blending is taught, the student says each sound in the word and then, when all of the sounds in the word have been spoken in isolation, the student blends the sounds together. A student blending the word *dog* using final blending would say the following:

1. /d/
2. /o/
3. /g/
4. blend: *dog*

Because blending is the last thing the student does, this procedure is called final blending.

Sequential blending is a little different because it requires the student to blend in chunks as he or she adds sounds, rather than waiting until he or she gets to the final sound. A student blending the word *dog* using sequential blending would say the following:

1. /d/
2. /o/
3. blend: *do* [dah]
4. /g/
5. blend again: *dog*

Some have argued that sequential blending is the superior method. They point out that if students are asked to blend four- and five-sound words, final blending begins to make greater demands on memory. It requires students to keep the earlier sounds in mind while they are thinking about the sound values of later letters in the word. For some students this may lead to a processing overload. They may forget the first sound by the time they get to the fourth or fifth one. By contrast, sequential blending asks students to blend each time a new sound is added, so the earlier sound values are constantly being freshened up with each episode of mid-word blending. This reduces the burden on memory.

Final blending is faster, less cumbersome in its procedures, more familiar to most teachers, and closer to the process students will later use when reading multisyllable words. Also, the differences between the two procedures are much less pronounced if initial instruction is confined to two- and three-sound words. When the student is blending only two sounds, final blending is no different than sequential blending, and when the student is blending three sounds the difference between the two is rather small, as can be seen in the two examples given here.

This program uses final blending as the basic procedure in the early units of Kindergarten. In the early units of Kindergarten students are asked to blend two or three sounds. It is not until later in the program—Units 6 and following—that students are asked to blend four and five sounds. By that point students should have had so much practice blending that the procedure is beginning to become automatic.

Most of the activities in the lessons can be tweaked so that they can be done with sequential blending, if you feel strongly about the issue. You should also be aware of sequential blending as an alternative mode of presentation that may be helpful for students who struggle with blending. If you have students who struggle with final blending, you might try to teach them to blend using sequential blending.

There are various gestures and motions that can be used to reinforce blending and make it visual and kinesthetic. Some of these gestures are introduced in the early units of Kindergarten. However, there are many variations, almost all of which can be added to the basic framework of the program without much difficulty. The particular movements are not very important; you can use any patterned, memorable set of movements that helps reinforce the idea of pushing discrete phonemes together to make a word.

## Finger Gestures for Blending

In the lessons, gestures for blending are taught that involve pointing to the shoulder, elbow, and wrist, and then sweeping along the arm while blending the sounds. Below, a different set of blending gestures is outlined that can be used to illustrate the same process. These gestures involve tapping fingers to represent individual sounds and then making a fist to represent the blending. In an earlier version of the curriculum we asked teachers to teach both sets of gestures, but some teachers felt that this was too many sets of gestures for the students to master. It was decided, therefore, to teach the arm gestures in the lessons. The arm gestures recommended in the lessons tap gross motor skills, whereas the finger gestures illustrated below tap fine motor skills. The arm motions may be easier for some children to master than the finger gestures. However, if you prefer the finger gestures, you should feel free to substitute them for the arm gestures.

- Tap thumb against pointer finger while saying first sound.
- Tap thumb against middle finger while saying second sound.
- Tap thumb against ring finger while saying third sound.
- Make a fist while blending the sounds.

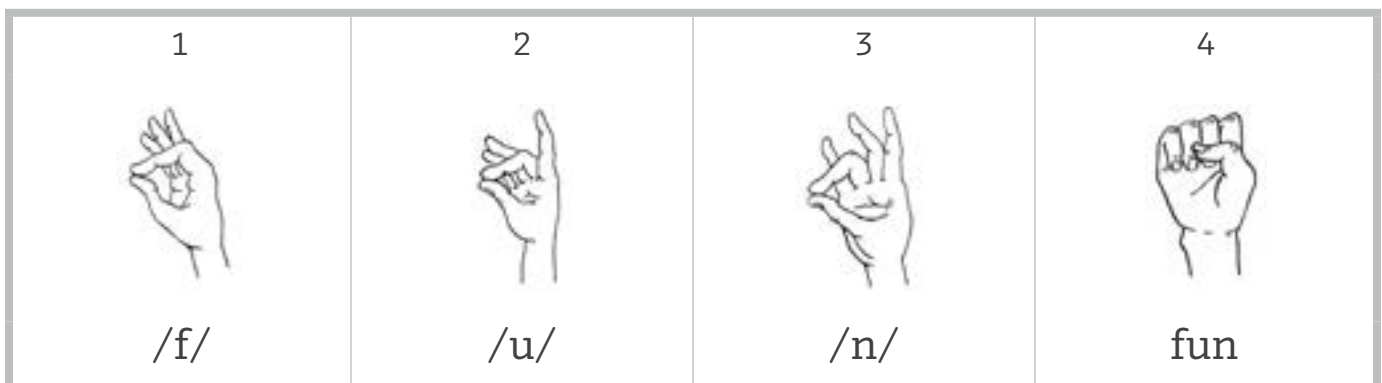

An advantage of the finger gestures is that it is easy to add a fourth sound, using the fourth finger. However, students will not be asked to blend four-sound words until Unit 6, by which point the gestures may have become less necessary.

## The Elusiveness of the Phoneme

One of the major goals of this unit is to get students to begin to be consciously aware that spoken words are made up of sounds, or phonemes. In their early years, children process language in a holistic way, with an emphasis on meaning. They can hear and understand a difference between the spoken words *bat* and *cat*. Therefore, on some level, they must be able to distinguish the sound /b/ from /k/; otherwise they would not be able to distinguish *bat* from *cat*. However, there is a difference between processing phonemes unconsciously and becoming consciously aware of phonemes. A growing body of evidence suggests most people are not consciously aware of phonemes—and have no reason to be aware of them—until they have to learn an alphabetic writing system such as our own.

José Morais of the University of Brussels and his colleagues did a series of important studies on phonemic awareness among European illiterates. They set up controlled experiments in which the literate and illiterate participants were asked to perform two phoneme-level oral language tasks.

Subjects were asked to make a new word (or pseudoword) by deleting an initial sound. For example, given the spoken word *phone*—/f/ /oe/ /n/—they would be asked to remove the initial sound—/f/—to make a new spoken word, in this case *own*—/oe/ /n/.

Subjects were asked to make a new word (or pseudoword) by adding an initial sound. Given the spoken word *pit*—/p/ /i/ /t/—they would be asked to generate a new word by adding the phoneme /s/ at the beginning, making /s/ /p/ /i/ /t/ (*spit*).

Morais found that his illiterate subjects were unable to perform either of these oral tasks, whereas his literate subjects could. He concluded that phonemic awareness is not a normal outcome of cognitive development and maturation. It is not something you just “grow into.” Rather, it is a specific skill you need to acquire, and which is usually acquired as part of literacy education. “The present results,” Morais wrote, “clearly indicate that the ability to deal explicitly with the phonetic units of speech is not acquired spontaneously.” Those subjects who had not learned to read an alphabetic writing system had no reason to pay attention to phonemes, and therefore had not acquired the ability to process language at the phoneme level. (Morais, et al., “Does Awareness of Speech as a Sequence of Phonemes Arise Spontaneously?” *Cognition* 7 (1979) pages 323–331.)

Another remarkable study a few years later confirmed the findings of Morais and his team. Charles Read worked with several Chinese scholars to test Chinese adults who had learned to read traditional Chinese characters (which stand for syllables), and had never learned to read Chinese using the pinyin alphabet, which is now taught in Chinese schools. These older Chinese men and women had learned a writing system in which symbols stand for syllables, but they had never been exposed to an alphabetic writing system, in which symbols stand for sounds. Read and his colleagues gave the Chinese subjects the same two oral language tests Morais had used. They found, as Morais and his collaborators had found, the subjects who had not learned to use an alphabet were largely unable to complete oral exercises at the phoneme level. They could not reliably create a new word (or pseudoword) by adding a sound. Nor could they create a new word (or

pseudoword) by deleting a sound. Their reading instruction had taught them to work at the syllabic level, but they were not able to work at the level of the single sound.

These examples may seem only tangentially connected to the business of teaching American children to read, but they are in fact highly relevant, for they indicate that the phoneme is not something we tend to notice in our everyday use of oral language. In fact, these studies demonstrate that there is something elusive about the phoneme. People can live their whole lives without becoming consciously aware of phonemes. They can even learn to read and write using a syllabic writing system without becoming consciously aware of subsyllabic units like the phoneme. Therefore, we must not think of phonemic awareness as a skill that develops naturally. There is nothing “natural” about phonemic awareness; in fact, there would be no reason to be aware of phonemes if our language were not written using an alphabet that represents phonemes. However, since our writing system is based on the phoneme, it is imperative that students develop phonemic awareness.

Since our writing system codes for sound at the phoneme level, and since the phoneme is somewhat elusive, you can see why the phonemic awareness activities in this unit are so important. They help to draw students' attention to segments of their speech that might otherwise go unrecognized, and set the stage for the introduction of letter-sound correspondences in the next unit.

# Appendix B

## LETTER-SOUND CORRESPONDENCE PRETEST

This optional pretest assesses each student's knowledge of letter-sound correspondences. It needs to be administered individually. Make multiple copies of the scoring sheet on the next page—one for each student you will be testing. Make one copy of the two pages showing the 37 graphemes (single letters and digraphs). Show the student the graphemes one at a time by pointing to them, beginning with the single-letter graphemes. Point to the grapheme and say, “If you saw this in a word, what **sound** would you say?” The student is to provide a sound for each grapheme (not the letter name). If the student supplies a letter name (e.g., “em”), say, “That’s a letter name. I want to know the sound.” If the student continues to provide the letter name, mark the response wrong.

**Scoring Notes:** Place a check on the line for each grapheme the student is able to pronounce correctly and an ‘x’ for each incorrect answer or failure to answer. Note that for two graphemes there are two possible answers, either of which should be counted as correct. If the student struggles with the single-letter graphemes, it is unnecessary to complete the digraphs.

At the beginning of Kindergarten any total score, even zero, is an acceptable score on this test. This program assumes students know none of the letter-sound correspondences tested on this pretest. The program teaches all of them (plus a number of others) in the course of Kindergarten. Anything students happen to know at the beginning of Kindergarten is a bonus. If you use this assessment, be sure to add it to your assessment portfolio.

## Letter-Sound Correspondences Scoring Sheet

Name: \_\_\_\_\_

Date: \_\_\_\_\_

1. \_\_\_\_\_ 'm' > /m/ as in *mat*
2. \_\_\_\_\_ 't' > /t/ as in *toy*
3. \_\_\_\_\_ 'd' > /d/ as in *dog*
4. \_\_\_\_\_ 'a' > /a/ as in *hat* (not letter name /ae/)
5. \_\_\_\_\_ 'c' > /k/ as in *cat*
6. \_\_\_\_\_ 'b' > /b/ as in *bad*
7. \_\_\_\_\_ 'o' > /o/ as in *hot* (not letter name /oe/)
8. \_\_\_\_\_ 'g' > /g/ as in *got* (not /j/ as in *gem*)
9. \_\_\_\_\_ 'f' > /f/ as in *fun*
10. \_\_\_\_\_ 'u' > /u/ as in *up* (not letter name /ue/)
11. \_\_\_\_\_ 'w' > /w/ as in *wet*
12. \_\_\_\_\_ 'z' > /z/ as in *zip*
13. \_\_\_\_\_ 'e' > /e/ as in *bed* (not letter name /ee/)
14. \_\_\_\_\_ 'h' > /h/ as in *hot*
15. \_\_\_\_\_ 'i' > /i/ as in *hit* (not letter name /ie/)
16. \_\_\_\_\_ 'j' > /j/ as in *jet*
17. \_\_\_\_\_ 'l' > /l/ as in *lot*
18. \_\_\_\_\_ 'r' > /r/ as in *red*
19. \_\_\_\_\_ 'k' > /k/ as in *kit*
20. \_\_\_\_\_ 'n' > /n/ as in *net*
21. \_\_\_\_\_ 'p' > /p/ as in *pin*
22. \_\_\_\_\_ 's' > /s/ as in *sit*
23. \_\_\_\_\_ 'v' > /v/ as in *van*
24. \_\_\_\_\_ 'x' > /x/ (/k/ + /s/) as in *tax*
25. \_\_\_\_\_ 'sh' > /sh/ as in *sheep*
26. \_\_\_\_\_ 'ee' > /ee/ as in *feet*
27. \_\_\_\_\_ 'ch' > /ch/ as in *chop*
28. \_\_\_\_\_ 'ng' > /ng/ as in *sing*
29. \_\_\_\_\_ 'th' > /th/ as in *thin* or /th/ as in *them*
30. \_\_\_\_\_ 'qu' > /qu/ (/k/ + /w/) as in *quick*
31. \_\_\_\_\_ 'ck' > /k/ as in *back*

**Notes:**

Letter-Sound Correspondence Pretest

|   |   |   |   |
|---|---|---|---|
| m | t | d | a |
| c | b | o | g |
| f | u | w | z |
| e | h | i | j |
| l | r | k | n |
| p | s | v | x |



Letter-Sound Correspondence Pretest

sh

ee

ch

ng

th

qu

ck

# Appendix C

## LETTER NAME PRETEST

This optional pretest assesses each student's knowledge of letter names. It needs to be administered individually. Make multiple copies of the scoring sheet on the next page—one for each student you will be testing. Make one copy of the Letter Name Pretest sheets that show 26 lowercase letters and 26 uppercase letters out of order. You may test lower case, upper case, or both cases. Lowercase letters are more relevant, as they are taught first. Tell the student you are going to show them some letters, and you would like them to tell you the letter names (not the sounds). Show the student the letters one at a time by pointing to them.

**Scoring Notes:** Place a check on the line for each letter the student is able to name correctly and an 'x' for each incorrect answer or failure to answer. Letter names are not taught until later in Kindergarten. Students who do not know the letter names will not be at a disadvantage in the early units. In fact, they may have an advantage over students who have learned the letter names because students who know the letter names may try to read words using the letter names instead of the sound values. This is a very common mistake among beginning readers. It leads students to read the word *cat* as 'see' 'ay' 'tee'. If any students who know letter names struggle to read in Unit 3 and following, it is possibly because they are trying to use the letter names to decode words instead of the sound values. If you use this assessment, be sure to add it to your assessment portfolio.

### Letter Name Scoring Sheet

Name: \_\_\_\_\_

Date: \_\_\_\_\_

|   |   |   |   |   |
|---|---|---|---|---|
| A | F | K | P | U |
| Z | B | G | L | Q |
| V | C | H | M | R |
| W | D | I | N | S |
| X | E | J | O | T |
| Y |   |   |   |   |
|   |   |   |   |   |
| a | f | k | p | u |
| z | b | g | l | q |
| v | c | h | m | r |
| w | d | i | n | s |
| x | e | j | o | t |
| y |   |   |   |   |

Letter Name Pretest

|   |   |   |   |
|---|---|---|---|
| A | F | K | P |
| U | Z | B | G |
| L | Q | V | C |
| H | M | R | W |
| D | I | N | S |
| X | E | J | O |
| T | Y |   |   |

Letter Name Pretest

|   |   |   |   |
|---|---|---|---|
| a | f | k | p |
| u | z | b | g |
| l | q | v | c |
| h | m | r | w |
| d | i | n | s |
| x | e | j | o |
| t | y |   |   |

# TEXAS ESSENTIAL KNOWLEDGE AND SKILLS - KINDERGARTEN

## Skills 2

## Correlation—Teacher’s Guide

(1) Developing and sustaining foundational language skills: listening, speaking, discussion, and thinking—oral language. The student develops oral language through listening, speaking, and discussion. The student is expected to:

|            |                                                                                                                          |                                                                            |
|------------|--------------------------------------------------------------------------------------------------------------------------|----------------------------------------------------------------------------|
| TEKS K.1.A | listen actively and ask questions to understand information and answer questions using multi-word responses              |                                                                            |
| TEKS K.1.B | restate and follow oral directions that involve a short, related sequence of actions                                     | U2: p. 7, U2: p. 10, U2: p. 11, U2: p. 16, U2: p. 19, U2: p. 25, U2: p. 28 |
| TEKS K.1.C | share information and ideas by speaking audibly and clearly using the conventions of language;                           |                                                                            |
| TEKS K.1.D | work collaboratively with others by following agreed-upon rules for discussion, including taking turns                   |                                                                            |
| TEKS K.1.E | develop social communication such as introducing himself/herself, using common greetings, and expressing needs and wants |                                                                            |

(2) Developing and sustaining foundational language skills: listening, speaking, reading, writing, and thinking—beginning reading and writing. The student develops word structure knowledge through phonological awareness, print concepts, phonics, and morphology to communicate, decode, and spell. The student is expected to:

(A) demonstrate phonological awareness by:

|                 |                                                                                                            |                                                                                                                                                                                                                                       |
|-----------------|------------------------------------------------------------------------------------------------------------|---------------------------------------------------------------------------------------------------------------------------------------------------------------------------------------------------------------------------------------|
| TEKS K.2.A.i    | identifying and producing rhyming words                                                                    |                                                                                                                                                                                                                                       |
| TEKS K.2.A.ii   | recognizing spoken alliteration or groups of words that begin with the same spoken onset or initial sound; |                                                                                                                                                                                                                                       |
| TEKS K.2.A.iii  | identifying the individual words in a spoken sentence;                                                     |                                                                                                                                                                                                                                       |
| TEKS K.2.A.iv   | identifying syllables in spoken words                                                                      | U2: p. 7, U2: p. 10, U2: p. 11, U2: p. 25, U2: p. 28                                                                                                                                                                                  |
| TEKS K.2.A.v    | blending syllables to form multisyllabic words                                                             | U2: p. 7, U2: p. 10, U2: p. 11, U2: p. 16, U2: p. 19, U2: p. 25, U2: p. 28, U2: p. 36, U2: p. 39                                                                                                                                      |
| TEKS K.2.A.vi   | segmenting multisyllabic words into syllables                                                              |                                                                                                                                                                                                                                       |
| TEKS K.2.A.vii  | blending spoken onsets and rimes to form simple words                                                      | U2: p. 25, U2: p. 28, U2: p. 29, U2: p. 31, U2: p. 90, U2: p. 95                                                                                                                                                                      |
| TEKS K.2.A.viii | blending spoken phonemes to form one-syllable words                                                        | U2: p. 16; U2: p. 19; U2: p. 25; U2: p. 28; U2: p. 29; U2: p. 31; U2: p. 36; U2: p. 39; U2: p. 46; U2: p. 49; U2: p. 55; U2: p. 58; U2: p. 64; U2: p. 67; U2: p. 72; U2: p. 75; U2: p. 81; U2: p. 84; U2: p. 90; U2: p. 93; U2: p. 95 |
| TEKS K.2.A.ix   | manipulating syllables within a multisyllabic word                                                         | U2: p. 7, U2: p. 10, U2: p. 11, U2: p. 46, U2: p. 49, U2: p. 54                                                                                                                                                                       |
| TEKS K.2.A.x    | segmenting spoken one-syllable words into individual phonemes                                              | U2: p. 36, U2: p. 39, U2: p. 46, U2: p. 49, U2: p. 55, U2: p. 58, U2: p. 64, U2: p. 67, U2: p. 72, U2: p. 75, U2: p. 90, U2: p. 93                                                                                                    |

(B) demonstrate and apply phonetic knowledge by:

|               |                                                                                     |  |
|---------------|-------------------------------------------------------------------------------------|--|
| TEKS K.2.B.i  | identifying and matching the common sounds that letters represent                   |  |
| TEKS K.2.B.ii | using letter-sound relationships to decode, including VC, CVC, CCVC, and CVCC words |  |

## TEXAS ESSENTIAL KNOWLEDGE AND SKILLS - KINDERGARTEN

### Skills 2

### Correlation—Teacher’s Guide

|                                                                                                                                                                                                                                                                                                                   |                                                                                                                                              |                                                                                                                                                                                                                                                 |
|-------------------------------------------------------------------------------------------------------------------------------------------------------------------------------------------------------------------------------------------------------------------------------------------------------------------|----------------------------------------------------------------------------------------------------------------------------------------------|-------------------------------------------------------------------------------------------------------------------------------------------------------------------------------------------------------------------------------------------------|
| TEKS K.2.B.iii                                                                                                                                                                                                                                                                                                    | recognizing that new words are created when letters are changed, added or deleted such as <i>it – pit – tip – tap</i>                        |                                                                                                                                                                                                                                                 |
| TEKS K.2.B.iv                                                                                                                                                                                                                                                                                                     | identifying and reading at least 25 high-frequency words from a research-based list.                                                         |                                                                                                                                                                                                                                                 |
| (C) demonstrate and apply spelling knowledge by:                                                                                                                                                                                                                                                                  |                                                                                                                                              |                                                                                                                                                                                                                                                 |
| TEKS K.2.C.i                                                                                                                                                                                                                                                                                                      | spelling words with VC, CVC, and CCVC                                                                                                        |                                                                                                                                                                                                                                                 |
| TEKS K.2.C.ii                                                                                                                                                                                                                                                                                                     | spelling words using sound-spelling patterns; and                                                                                            |                                                                                                                                                                                                                                                 |
| TEKS K.2.C.iii                                                                                                                                                                                                                                                                                                    | spelling high-frequency words from a research-based list                                                                                     |                                                                                                                                                                                                                                                 |
| (D) demonstrate print awareness by:                                                                                                                                                                                                                                                                               |                                                                                                                                              |                                                                                                                                                                                                                                                 |
| TEKS K.2.D.i                                                                                                                                                                                                                                                                                                      | identifying the front cover, back cover, and title page of a book                                                                            |                                                                                                                                                                                                                                                 |
| TEKS K.2.D.ii                                                                                                                                                                                                                                                                                                     | holding a book right side up, turning pages correctly, and knowing that reading moves from top to bottom and left to right with return sweep | U2: p. 7, U2: p. 10, U2: p. 12, U2: p. 36, U2: p. 42                                                                                                                                                                                            |
| TEKS K.2.D.iii                                                                                                                                                                                                                                                                                                    | recognizing that sentences are comprised of words separated by spaces and recognizing word boundaries                                        |                                                                                                                                                                                                                                                 |
| TEKS K.2.D.iv                                                                                                                                                                                                                                                                                                     | recognizing the difference between a letter and a printed word                                                                               |                                                                                                                                                                                                                                                 |
| TEKS K.2.D.v                                                                                                                                                                                                                                                                                                      | identifying all uppercase and lowercase letters                                                                                              |                                                                                                                                                                                                                                                 |
| TEKS K.2.E                                                                                                                                                                                                                                                                                                        | develop handwriting by accurately forming all uppercase and lowercase letters using appropriate directionality                               |                                                                                                                                                                                                                                                 |
| (3) Developing and sustaining foundational language skills: listening, speaking, reading, writing, and thinking—vocabulary. The student uses newly acquired vocabulary expressively. The student is expected to:                                                                                                  |                                                                                                                                              |                                                                                                                                                                                                                                                 |
| TEKS K.3.A                                                                                                                                                                                                                                                                                                        | use a resource such as a picture dictionary or digital resource to find words                                                                |                                                                                                                                                                                                                                                 |
| TEKS K.3.B                                                                                                                                                                                                                                                                                                        | use illustrations and texts the student is able to read or hear to learn or clarify word meanings                                            |                                                                                                                                                                                                                                                 |
| TEKS K.3.C                                                                                                                                                                                                                                                                                                        | identify and use words that name actions; directions; positions; sequences; categories such as colors, shapes, and textures; and locations.  | U2: p. 7, U2: p. 13; U2: p. 16, U2: p. 22; U2: p. 25; U2: p. 32; U2: p. 33; U2: p. 36; U2: p. 42; U2: p. 43; U2: p. 46; U2: p. 52; U2: p. 55; U2: p. 60; U2: p. 64; U2: p. 69; U2: p. 72; U2: p. 77; U2: p. 81; U2: p. 86; U2: p. 90, U2: p. 95 |
| (4) Developing and sustaining foundational language skills: listening, speaking, reading, writing, and thinking—self-sustained reading. The student reads grade-appropriate texts independently. The student is expected to self-select text and interact independently with text for increasing periods of time. |                                                                                                                                              |                                                                                                                                                                                                                                                 |
| TEKS K.4                                                                                                                                                                                                                                                                                                          | self-select text and interact independently with text for increasing periods of time                                                         |                                                                                                                                                                                                                                                 |
| (5) Comprehension skills: listening, speaking, reading, writing, and thinking using multiple texts. The student uses metacognitive skills to both develop and deepen comprehension of increasingly complex texts. The student is expected to:                                                                     |                                                                                                                                              |                                                                                                                                                                                                                                                 |
| TEKS K.5.A                                                                                                                                                                                                                                                                                                        | establish purpose for reading assigned and self-selected texts with adult assistance                                                         |                                                                                                                                                                                                                                                 |
| TEKS K.5.B                                                                                                                                                                                                                                                                                                        | generate questions about a text before, during, and after reading to deepen understanding and gain information with adult assistance         |                                                                                                                                                                                                                                                 |

## TEXAS ESSENTIAL KNOWLEDGE AND SKILLS - KINDERGARTEN

| <b>Skills 2</b>                                                                                                                                                                                                                                                                                                                |                                                                                                                                                                                                | <b>Correlation—Teacher’s Guide</b> |
|--------------------------------------------------------------------------------------------------------------------------------------------------------------------------------------------------------------------------------------------------------------------------------------------------------------------------------|------------------------------------------------------------------------------------------------------------------------------------------------------------------------------------------------|------------------------------------|
| TEKS K.5.C                                                                                                                                                                                                                                                                                                                     | make and confirm predictions using text features and structures with adult assistance                                                                                                          |                                    |
| TEKS K.5.D                                                                                                                                                                                                                                                                                                                     | create mental images to deepen understanding with adult assistance                                                                                                                             |                                    |
| TEKS K.5.E                                                                                                                                                                                                                                                                                                                     | make connections to personal experiences, to ideas in other texts, and society with adult assistance                                                                                           |                                    |
| TEKS K.5.F                                                                                                                                                                                                                                                                                                                     | make inferences and use evidence to support understanding with adult assistance                                                                                                                |                                    |
| TEKS K.5.G                                                                                                                                                                                                                                                                                                                     | evaluate details to determine what is most important with adult assistance                                                                                                                     |                                    |
| TEKS K.5.H                                                                                                                                                                                                                                                                                                                     | synthesize information to create new understanding with adult assistance                                                                                                                       |                                    |
| TEKS K.5.I                                                                                                                                                                                                                                                                                                                     | monitor comprehension and make adjustments such as re-reading, using background knowledge, checking for visual cues, and asking questions when understanding breaks down with adult assistance |                                    |
| (6) Response skills: listening, speaking, reading, writing, and thinking using multiple texts. The student responds to an increasingly challenging variety of sources that are read, heard, or viewed. The student is expected to:                                                                                             |                                                                                                                                                                                                |                                    |
| TEKS K.6.A                                                                                                                                                                                                                                                                                                                     | describe personal connections to a variety of sources                                                                                                                                          |                                    |
| TEKS K.6.B                                                                                                                                                                                                                                                                                                                     | provide an oral, pictorial, or written response to a text                                                                                                                                      |                                    |
| TEKS K.6.C                                                                                                                                                                                                                                                                                                                     | use text evidence to support an appropriate response                                                                                                                                           |                                    |
| TEKS K.6.D                                                                                                                                                                                                                                                                                                                     | retell texts in ways that maintain meaning                                                                                                                                                     |                                    |
| TEKS K.6.E                                                                                                                                                                                                                                                                                                                     | interact with sources in meaningful ways such as illustrating or writing                                                                                                                       |                                    |
| TEKS K.6.F                                                                                                                                                                                                                                                                                                                     | respond using newly acquired vocabulary as appropriate                                                                                                                                         |                                    |
| (7) Multiple genres: listening, speaking, reading, writing, and thinking using multiple texts—literary elements. The student recognizes and analyzes literary elements within and across increasingly complex traditional, contemporary, classical, and diverse literary texts. The student is expected to:                    |                                                                                                                                                                                                |                                    |
| TEKS K.7.A                                                                                                                                                                                                                                                                                                                     | discuss topics and determine the basic theme using text evidence with adult assistance                                                                                                         |                                    |
| TEKS K.7.B                                                                                                                                                                                                                                                                                                                     | identify and describe the main character(s)                                                                                                                                                    |                                    |
| TEKS K.7.C                                                                                                                                                                                                                                                                                                                     | identify the elements of plot development including the main events, the problem, and the resolution for texts read aloud with adult assistance                                                |                                    |
| TEKS K.7.D                                                                                                                                                                                                                                                                                                                     | describe the setting                                                                                                                                                                           |                                    |
| (8) Multiple genres: listening, speaking, reading, writing, and thinking using multiple texts—genres. The student recognizes and analyzes genre-specific characteristics, structures, and purposes within and across increasingly complex traditional, contemporary, classical, and diverse texts. The student is expected to: |                                                                                                                                                                                                |                                    |
| TEKS K.8.A                                                                                                                                                                                                                                                                                                                     | demonstrate knowledge of distinguishing characteristics of well-known children’s literature, such as folktales, fables, fairy tales, and nursery rhymes                                        |                                    |
| TEKS K.8.B                                                                                                                                                                                                                                                                                                                     | discuss rhyme and rhythm in nursery rhymes and a variety of poems                                                                                                                              |                                    |
| TEKS K.8.C                                                                                                                                                                                                                                                                                                                     | discuss main characters in drama                                                                                                                                                               |                                    |
| (D) recognize characteristics and structures of informational text, including                                                                                                                                                                                                                                                  |                                                                                                                                                                                                |                                    |
| TEKS K.8.D.i                                                                                                                                                                                                                                                                                                                   | the central idea and supporting evidence, with adult assistance                                                                                                                                |                                    |
| TEKS K.8.D.ii                                                                                                                                                                                                                                                                                                                  | titles and simple graphics to gain information                                                                                                                                                 |                                    |



## TEXAS ESSENTIAL KNOWLEDGE AND SKILLS - KINDERGARTEN

| <b>Skills 2</b>                                                                                                                                                                                                                                                                                                                                                                                              |                                                                                                                                              | <b>Correlation—Teacher’s Guide</b> |
|--------------------------------------------------------------------------------------------------------------------------------------------------------------------------------------------------------------------------------------------------------------------------------------------------------------------------------------------------------------------------------------------------------------|----------------------------------------------------------------------------------------------------------------------------------------------|------------------------------------|
| TEKS K.8.D.iii                                                                                                                                                                                                                                                                                                                                                                                               | the steps in a sequence with adult assistance.                                                                                               |                                    |
| TEKS K.8.E                                                                                                                                                                                                                                                                                                                                                                                                   | recognize characteristics of persuasive text with adult assistance and state what the author is trying to persuade the reader to think or do |                                    |
| TEKS K.8.F                                                                                                                                                                                                                                                                                                                                                                                                   | recognize characteristics of multimodal and digital texts                                                                                    |                                    |
| (9) Author’s purpose and craft: listening, speaking, reading, writing, and thinking using multiple texts. The student uses critical inquiry to analyze the authors’ choices and how they influence and communicate meaning within a variety of texts. The student analyzes and applies author’s craft purposefully in order to develop his or her own products and performances. The student is expected to: |                                                                                                                                              |                                    |
| TEKS K.9.A                                                                                                                                                                                                                                                                                                                                                                                                   | discuss with adult assistance the author’s purpose for writing text                                                                          |                                    |
| TEKS K.9.B                                                                                                                                                                                                                                                                                                                                                                                                   | discuss with adult assistance how the use of text structure contributes to the author’s purpose                                              |                                    |
| TEKS K.9.C                                                                                                                                                                                                                                                                                                                                                                                                   | discuss with adult assistance the author’s use of print and graphic features to achieve specific purposes                                    |                                    |
| TEKS K.9.D                                                                                                                                                                                                                                                                                                                                                                                                   | discuss with adult assistance how the author uses words that help the reader visualize                                                       |                                    |
| TEKS K.9.E                                                                                                                                                                                                                                                                                                                                                                                                   | listen to and experience first- and third-person texts                                                                                       |                                    |
| (10) Composition: listening, speaking, reading, writing, and thinking using multiple texts—writing process. The student uses the writing process recursively to compose multiple texts that are legible and uses appropriate conventions. The student is expected to:                                                                                                                                        |                                                                                                                                              |                                    |
| TEKS K.10.A                                                                                                                                                                                                                                                                                                                                                                                                  | plan by generating ideas for writing through class discussions and drawings                                                                  |                                    |
| TEKS K.10.B                                                                                                                                                                                                                                                                                                                                                                                                  | develop drafts in oral, pictorial, or written form by organizing ideas                                                                       |                                    |
| TEKS K.10.C                                                                                                                                                                                                                                                                                                                                                                                                  | revise drafts by adding details in pictures or words                                                                                         |                                    |
| (D) edit drafts with adult assistance using standard English conventions, including:                                                                                                                                                                                                                                                                                                                         |                                                                                                                                              |                                    |
| TEKS K.10.D.i                                                                                                                                                                                                                                                                                                                                                                                                | complete sentences                                                                                                                           |                                    |
| TEKS K.10.D.ii                                                                                                                                                                                                                                                                                                                                                                                               | verbs                                                                                                                                        |                                    |
| TEKS K.10.D.iii                                                                                                                                                                                                                                                                                                                                                                                              | singular and plural nouns                                                                                                                    |                                    |
| TEKS K.10.D.iv                                                                                                                                                                                                                                                                                                                                                                                               | adjectives, including articles                                                                                                               |                                    |
| TEKS K.10.D.v                                                                                                                                                                                                                                                                                                                                                                                                | prepositions                                                                                                                                 |                                    |
| TEKS K.10.D.vi                                                                                                                                                                                                                                                                                                                                                                                               | pronouns, including subjective, objective, and possessive cases                                                                              |                                    |
| TEKS K.10.D.vii                                                                                                                                                                                                                                                                                                                                                                                              | capitalization of the first letter in a sentence and name                                                                                    |                                    |
| TEKS K.10.D.viii                                                                                                                                                                                                                                                                                                                                                                                             | punctuation marks at the end of declarative sentences                                                                                        |                                    |
| TEKS K.10.D.ix                                                                                                                                                                                                                                                                                                                                                                                               | correct spelling of words with grade-appropriate orthographic patterns and rules and high-frequency words                                    |                                    |
| TEKS K.10.E                                                                                                                                                                                                                                                                                                                                                                                                  | share writing                                                                                                                                |                                    |
| (11) Composition: listening, speaking, reading, writing, and thinking using multiple texts—genres. The student uses genre characteristics and craft to compose multiple texts that are meaningful. The student is expected to:                                                                                                                                                                               |                                                                                                                                              |                                    |
| TEKS K.11.A                                                                                                                                                                                                                                                                                                                                                                                                  | dictate or compose literary texts, including personal narratives                                                                             |                                    |
| TEKS K.11.B                                                                                                                                                                                                                                                                                                                                                                                                  | dictate or compose informational texts                                                                                                       |                                    |

**Skills 2**

**Correlation—Teacher’s Guide**

(12) Inquiry and research: listening, speaking, reading, writing, and thinking using multiple texts. The student engages in both short-term and sustained recursive inquiry processes for a variety of purposes. The student is expected to:

|             |                                                                                               |  |
|-------------|-----------------------------------------------------------------------------------------------|--|
| TEKS K.12.A | generate questions for formal and informal inquiry with adult assistance                      |  |
| TEKS K.12.B | develop and follow a research plan with adult assistance                                      |  |
| TEKS K.12.C | gather information from a variety of sources with adult assistance                            |  |
| TEKS K.12.D | demonstrate understanding of information gathered with adult assistance                       |  |
| TEKS K.12.E | use an appropriate mode of delivery, whether written, oral, or multimodal, to present results |  |

## ENGLISH LANGUAGE PROFICIENCY STANDARDS - KINDERGARTEN

### Skills 2

### Correlation—Teacher's Guide

|                                                                                                                                                                                                                                                                                                                                                                                                                                                                                                                                                                                                                                                                                                                            |                                                                                                                                                                                                                                |  |
|----------------------------------------------------------------------------------------------------------------------------------------------------------------------------------------------------------------------------------------------------------------------------------------------------------------------------------------------------------------------------------------------------------------------------------------------------------------------------------------------------------------------------------------------------------------------------------------------------------------------------------------------------------------------------------------------------------------------------|--------------------------------------------------------------------------------------------------------------------------------------------------------------------------------------------------------------------------------|--|
| <p>(1) Cross-curricular second language acquisition/learning strategies. The ELL uses language learning strategies to develop an awareness of his or her own learning processes in all content areas. In order for the ELL to meet grade-level learning expectations across the foundation and enrichment curriculum, all instruction delivered in English must be linguistically accommodated (communicated, sequenced, and scaffolded) commensurate with the student's level of English language proficiency. The student is expected to:</p>                                                                                                                                                                            |                                                                                                                                                                                                                                |  |
| ELPS 1.A                                                                                                                                                                                                                                                                                                                                                                                                                                                                                                                                                                                                                                                                                                                   | use prior knowledge and experiences to understand meanings in English                                                                                                                                                          |  |
| ELPS 1.B                                                                                                                                                                                                                                                                                                                                                                                                                                                                                                                                                                                                                                                                                                                   | monitor oral and written language production and employ self-corrective techniques or other resources                                                                                                                          |  |
| ELPS 1.C                                                                                                                                                                                                                                                                                                                                                                                                                                                                                                                                                                                                                                                                                                                   | use strategic learning techniques such as concept mapping, drawing, memorizing, comparing, contrasting, and reviewing to acquire basic and grade-level vocabulary                                                              |  |
| ELPS 1.D                                                                                                                                                                                                                                                                                                                                                                                                                                                                                                                                                                                                                                                                                                                   | speak using learning strategies such as requesting assistance, employing non-verbal cues, and using synonyms and circumlocution (conveying ideas by defining or describing when exact English words are not known)             |  |
| ELPS 1.E                                                                                                                                                                                                                                                                                                                                                                                                                                                                                                                                                                                                                                                                                                                   | internalize new basic and academic language by using and reusing it in meaningful ways in speaking and writing activities that build concept and language attainment                                                           |  |
| ELPS 1.F                                                                                                                                                                                                                                                                                                                                                                                                                                                                                                                                                                                                                                                                                                                   | use accessible language and learn new and essential language in the process                                                                                                                                                    |  |
| ELPS 1.G                                                                                                                                                                                                                                                                                                                                                                                                                                                                                                                                                                                                                                                                                                                   | demonstrate an increasing ability to distinguish between formal and informal English and an increasing knowledge of when to use each one commensurate with grade-level learning expectations                                   |  |
| ELPS 1.H                                                                                                                                                                                                                                                                                                                                                                                                                                                                                                                                                                                                                                                                                                                   | develop and expand repertoire of learning strategies such as reasoning inductively or deductively, looking for patterns in language, and analyzing sayings and expressions commensurate with grade-level learning expectations |  |
| <p>(2) Cross-curricular second language acquisition/listening. The ELL listens to a variety of speakers including teachers, peers, and electronic media to gain an increasing level of comprehension of newly acquired language in all content areas. ELLs may be at the beginning, intermediate, advanced, or advanced high stage of English language acquisition in listening. In order for the ELL to meet grade-level learning expectations across the foundation and enrichment curriculum, all instruction delivered in English must be linguistically accommodated (communicated, sequenced, and scaffolded) commensurate with the student's level of English language proficiency. The student is expected to:</p> |                                                                                                                                                                                                                                |  |
| ELPS 2.A                                                                                                                                                                                                                                                                                                                                                                                                                                                                                                                                                                                                                                                                                                                   | distinguish sounds and intonation patterns of English with increasing ease                                                                                                                                                     |  |
| ELPS 2.B                                                                                                                                                                                                                                                                                                                                                                                                                                                                                                                                                                                                                                                                                                                   | recognize elements of the English sound system in newly acquired vocabulary such as long and short vowels, silent letters, and consonant clusters                                                                              |  |
| ELPS 2.C                                                                                                                                                                                                                                                                                                                                                                                                                                                                                                                                                                                                                                                                                                                   | learn new language structures, expressions, and basic and academic vocabulary heard during classroom instruction and interactions                                                                                              |  |
| ELPS 2.D                                                                                                                                                                                                                                                                                                                                                                                                                                                                                                                                                                                                                                                                                                                   | monitor understanding of spoken language during classroom instruction and interactions and seek clarification as needed                                                                                                        |  |
| ELPS 2.E                                                                                                                                                                                                                                                                                                                                                                                                                                                                                                                                                                                                                                                                                                                   | use visual, contextual, and linguistic support to enhance and confirm understanding of increasingly complex and elaborated spoken language                                                                                     |  |

## ENGLISH LANGUAGE PROFICIENCY STANDARDS - KINDERGARTEN

| Skills 2                                                                                                                                                                                                                                                                                                                                                                                                                                                                                                                                                                                                                                                                                                                                                           |                                                                                                                                                                                                                                                                                                                                                  | Correlation—Teacher’s Guide |
|--------------------------------------------------------------------------------------------------------------------------------------------------------------------------------------------------------------------------------------------------------------------------------------------------------------------------------------------------------------------------------------------------------------------------------------------------------------------------------------------------------------------------------------------------------------------------------------------------------------------------------------------------------------------------------------------------------------------------------------------------------------------|--------------------------------------------------------------------------------------------------------------------------------------------------------------------------------------------------------------------------------------------------------------------------------------------------------------------------------------------------|-----------------------------|
| ELPS 2.F                                                                                                                                                                                                                                                                                                                                                                                                                                                                                                                                                                                                                                                                                                                                                           | listen to and derive meaning from a variety of media such as audio tape, video, DVD, and CD ROM to build and reinforce concept and language attainment                                                                                                                                                                                           |                             |
| ELPS 2.G                                                                                                                                                                                                                                                                                                                                                                                                                                                                                                                                                                                                                                                                                                                                                           | understand the general meaning, main points, and important details of spoken language ranging from situations in which topics, language, and contexts are familiar to unfamiliar                                                                                                                                                                 |                             |
| ELPS 2.H                                                                                                                                                                                                                                                                                                                                                                                                                                                                                                                                                                                                                                                                                                                                                           | understand implicit ideas and information in increasingly complex spoken language commensurate with grade-level learning expectations                                                                                                                                                                                                            |                             |
| ELPS 2.I                                                                                                                                                                                                                                                                                                                                                                                                                                                                                                                                                                                                                                                                                                                                                           | demonstrate listening comprehension of increasingly complex spoken English by following directions, retelling or summarizing spoken messages, responding to questions and requests, collaborating with peers, and taking notes commensurate with content and grade-level needs                                                                   |                             |
| <p>(3) Cross-curricular second language acquisition/speaking. The ELL speaks in a variety of modes for a variety of purposes with an awareness of different language registers (formal/informal) using vocabulary with increasing fluency and accuracy in language arts and all content areas. ELLs may be at the beginning, intermediate, advanced, or advanced high stage of English language acquisition in speaking. In order for the ELL to meet grade-level learning expectations across the foundation and enrichment curriculum, all instruction delivered in English must be linguistically accommodated (communicated, sequenced, and scaffolded) commensurate with the student’s level of English language proficiency. The student is expected to:</p> |                                                                                                                                                                                                                                                                                                                                                  |                             |
| ELPS 3.A                                                                                                                                                                                                                                                                                                                                                                                                                                                                                                                                                                                                                                                                                                                                                           | practice producing sounds of newly acquired vocabulary such as long and short vowels, silent letters, and consonant clusters to pronounce English words in a manner that is increasingly comprehensible                                                                                                                                          |                             |
| ELPS 3.B                                                                                                                                                                                                                                                                                                                                                                                                                                                                                                                                                                                                                                                                                                                                                           | expand and internalize initial English vocabulary by learning and using high-frequency English words necessary for identifying and describing people, places, and objects, by retelling simple stories and basic information represented or supported by pictures, and by learning and using routine language needed for classroom communication |                             |
| ELPS 3.C                                                                                                                                                                                                                                                                                                                                                                                                                                                                                                                                                                                                                                                                                                                                                           | speak using a variety of grammatical structures, sentence lengths, sentence types, and connecting words with increasing accuracy and ease as more English is acquired                                                                                                                                                                            |                             |
| ELPS 3.D                                                                                                                                                                                                                                                                                                                                                                                                                                                                                                                                                                                                                                                                                                                                                           | speak using grade-level content area vocabulary in context to internalize new English words and build academic language proficiency                                                                                                                                                                                                              |                             |
| ELPS 3.E                                                                                                                                                                                                                                                                                                                                                                                                                                                                                                                                                                                                                                                                                                                                                           | share information in cooperative learning interactions                                                                                                                                                                                                                                                                                           |                             |
| ELPS 3.F                                                                                                                                                                                                                                                                                                                                                                                                                                                                                                                                                                                                                                                                                                                                                           | ask and give information ranging from using a very limited bank of high-frequency, high-need, concrete vocabulary, including key words and expressions needed for basic communication in academic and social contexts, to using abstract and content-based vocabulary during extended speaking assignments                                       |                             |
| ELPS 3.G                                                                                                                                                                                                                                                                                                                                                                                                                                                                                                                                                                                                                                                                                                                                                           | express opinions, ideas, and feelings ranging from communicating single words and short phrases to participating in extended discussions on a variety of social and grade-appropriate academic topics                                                                                                                                            |                             |
| ELPS 3.H                                                                                                                                                                                                                                                                                                                                                                                                                                                                                                                                                                                                                                                                                                                                                           | narrate, describe, and explain with increasing specificity and detail as more English is acquired                                                                                                                                                                                                                                                |                             |

## ENGLISH LANGUAGE PROFICIENCY STANDARDS - KINDERGARTEN

| <b>Skills 2</b>                                                                                                                                                                                                                                                                                                                                                                                                                                                                                                                                                                                                                                                                                                                                                                                                     |                                                                                                                                                                                                                                                                                                  | <b>Correlation—Teacher’s Guide</b>                                                                           |
|---------------------------------------------------------------------------------------------------------------------------------------------------------------------------------------------------------------------------------------------------------------------------------------------------------------------------------------------------------------------------------------------------------------------------------------------------------------------------------------------------------------------------------------------------------------------------------------------------------------------------------------------------------------------------------------------------------------------------------------------------------------------------------------------------------------------|--------------------------------------------------------------------------------------------------------------------------------------------------------------------------------------------------------------------------------------------------------------------------------------------------|--------------------------------------------------------------------------------------------------------------|
| ELPS 3.I                                                                                                                                                                                                                                                                                                                                                                                                                                                                                                                                                                                                                                                                                                                                                                                                            | adapt spoken language appropriately for formal and informal purposes                                                                                                                                                                                                                             |                                                                                                              |
| ELPS 3.J                                                                                                                                                                                                                                                                                                                                                                                                                                                                                                                                                                                                                                                                                                                                                                                                            | respond orally to information presented in a wide variety of print, electronic, audio, and visual media to build and reinforce concept and language attainment                                                                                                                                   |                                                                                                              |
| <p>(4) Cross-curricular second language acquisition/reading. The ELL reads a variety of texts for a variety of purposes with an increasing level of comprehension in all content areas. ELLs may be at the beginning, intermediate, advanced, or advanced high stage of English language acquisition in reading. In order for the ELL to meet grade-level learning expectations across the foundation and enrichment curriculum, all instruction delivered in English must be linguistically accommodated (communicated, sequenced, and scaffolded) commensurate with the student’s level of English language proficiency. For kindergarten and grade 1, certain of these student expectations apply to text read aloud for students not yet at the stage of decoding written text. The student is expected to:</p> |                                                                                                                                                                                                                                                                                                  |                                                                                                              |
| ELPS 4.A                                                                                                                                                                                                                                                                                                                                                                                                                                                                                                                                                                                                                                                                                                                                                                                                            | learn relationships between sounds and letters of the English language and decode (sound out) words using a combination of skills such as recognizing sound-letter relationships and identifying cognates, affixes, roots, and base words                                                        |                                                                                                              |
| ELPS 4.B                                                                                                                                                                                                                                                                                                                                                                                                                                                                                                                                                                                                                                                                                                                                                                                                            | recognize directionality of English reading such as left to right and top to bottom                                                                                                                                                                                                              |                                                                                                              |
| ELPS 4.C                                                                                                                                                                                                                                                                                                                                                                                                                                                                                                                                                                                                                                                                                                                                                                                                            | develop basic sight vocabulary, derive meaning of environmental print, and comprehend English vocabulary and language structures used routinely in written classroom materials                                                                                                                   |                                                                                                              |
| ELPS 4.D                                                                                                                                                                                                                                                                                                                                                                                                                                                                                                                                                                                                                                                                                                                                                                                                            | use prereading supports such as graphic organizers, illustrations, and pretaught topic-related vocabulary and other prereading activities to enhance comprehension of written text                                                                                                               |                                                                                                              |
| ELPS 4.E                                                                                                                                                                                                                                                                                                                                                                                                                                                                                                                                                                                                                                                                                                                                                                                                            | read linguistically accommodated content area material with a decreasing need for linguistic accommodations as more English is learned                                                                                                                                                           |                                                                                                              |
| ELPS 4.F                                                                                                                                                                                                                                                                                                                                                                                                                                                                                                                                                                                                                                                                                                                                                                                                            | use visual and contextual support and support from peers and teachers to read grade-appropriate content area text, enhance and confirm understanding, and develop vocabulary, grasp of language structures, and background knowledge needed to comprehend increasingly challenging language      | U2: p. 11, U2: p. 20, U2: p. 29, U2: p. 42, U2: p. 49, U2: p. 58, U2: p. 68, U2: p. 75, U2: p. 85, U2: p. 94 |
| ELPS 4.G                                                                                                                                                                                                                                                                                                                                                                                                                                                                                                                                                                                                                                                                                                                                                                                                            | demonstrate comprehension of increasingly complex English by participating in shared reading, retelling or summarizing material, responding to questions, and taking notes commensurate with content area and grade level needs                                                                  |                                                                                                              |
| ELPS 4.H                                                                                                                                                                                                                                                                                                                                                                                                                                                                                                                                                                                                                                                                                                                                                                                                            | read silently with increasing ease and comprehension for longer periods                                                                                                                                                                                                                          |                                                                                                              |
| ELPS 4.I                                                                                                                                                                                                                                                                                                                                                                                                                                                                                                                                                                                                                                                                                                                                                                                                            | demonstrate English comprehension and expand reading skills by employing basic reading skills such as demonstrating understanding of supporting ideas and details in text and graphic sources, summarizing text, and distinguishing main ideas from details commensurate with content area needs |                                                                                                              |

## ENGLISH LANGUAGE PROFICIENCY STANDARDS - KINDERGARTEN

| Skills 2                                                                                                                                                                                                                                                                                                                                                                                                                                                                                                                                                                                                                                                                                                                                                                                                                                                             |                                                                                                                                                                                                                                                                                                      | Correlation—Teacher’s Guide |
|----------------------------------------------------------------------------------------------------------------------------------------------------------------------------------------------------------------------------------------------------------------------------------------------------------------------------------------------------------------------------------------------------------------------------------------------------------------------------------------------------------------------------------------------------------------------------------------------------------------------------------------------------------------------------------------------------------------------------------------------------------------------------------------------------------------------------------------------------------------------|------------------------------------------------------------------------------------------------------------------------------------------------------------------------------------------------------------------------------------------------------------------------------------------------------|-----------------------------|
| ELPS 4.J                                                                                                                                                                                                                                                                                                                                                                                                                                                                                                                                                                                                                                                                                                                                                                                                                                                             | demonstrate English comprehension and expand reading skills by employing inferential skills such as predicting, making connections between ideas, drawing inferences and conclusions from text and graphic sources, and finding supporting text evidence commensurate with content area needs        |                             |
| ELPS 4.K                                                                                                                                                                                                                                                                                                                                                                                                                                                                                                                                                                                                                                                                                                                                                                                                                                                             | demonstrate English comprehension and expand reading skills by employing analytical skills such as evaluating written information and performing critical analyses commensurate with content area and grade-level needs                                                                              |                             |
| <p>(5) Cross-curricular second language acquisition/writing. The ELL writes in a variety of forms with increasing accuracy to effectively address a specific purpose and audience in all content areas. ELLs may be at the beginning, intermediate, advanced, or advanced high stage of English language acquisition in writing. In order for the ELL to meet grade-level learning expectations across foundation and enrichment curriculum, all instruction delivered in English must be linguistically accommodated (communicated, sequenced, and scaffolded) commensurate with the student’s level of English language proficiency. For kindergarten and grade 1, certain of these student expectations do not apply until the student has reached the stage of generating original written text using a standard writing system. The student is expected to:</p> |                                                                                                                                                                                                                                                                                                      |                             |
| ELPS 5.A                                                                                                                                                                                                                                                                                                                                                                                                                                                                                                                                                                                                                                                                                                                                                                                                                                                             | learn relationships between sounds and letters of the English language to represent sounds when writing in English                                                                                                                                                                                   |                             |
| ELPS 5.B                                                                                                                                                                                                                                                                                                                                                                                                                                                                                                                                                                                                                                                                                                                                                                                                                                                             | write using newly acquired basic vocabulary and content-based grade-level vocabulary                                                                                                                                                                                                                 |                             |
| ELPS 5.C                                                                                                                                                                                                                                                                                                                                                                                                                                                                                                                                                                                                                                                                                                                                                                                                                                                             | spell familiar English words with increasing accuracy, and employ English spelling patterns and rules with increasing accuracy as more English is acquired                                                                                                                                           |                             |
| ELPS 5.D                                                                                                                                                                                                                                                                                                                                                                                                                                                                                                                                                                                                                                                                                                                                                                                                                                                             | edit writing for standard grammar and usage, including subject-verb agreement, pronoun agreement, and appropriate verb tenses commensurate with grade-level expectations as more English is acquired                                                                                                 |                             |
| ELPS 5.E                                                                                                                                                                                                                                                                                                                                                                                                                                                                                                                                                                                                                                                                                                                                                                                                                                                             | employ increasingly complex grammatical structures in content area writing commensurate with grade level expectations such as (i) using correct verbs, tenses, and pronouns/antecedents; (ii) using possessive case (apostrophe -s) correctly; and, (iii) using negatives and contractions correctly |                             |
| ELPS 5.F                                                                                                                                                                                                                                                                                                                                                                                                                                                                                                                                                                                                                                                                                                                                                                                                                                                             | write using a variety of grade-appropriate sentence lengths, patterns, and connecting words to combine phrases, clauses, and sentences in increasingly accurate ways as more English is acquired                                                                                                     |                             |
| ELPS 5.G                                                                                                                                                                                                                                                                                                                                                                                                                                                                                                                                                                                                                                                                                                                                                                                                                                                             | narrate, describe, and explain with increasing specificity and detail to fulfill content area writing needs as more English is acquired                                                                                                                                                              |                             |

## General Manager K-8 Humanities and SVP, Product

Alexandra Clarke

## Chief Academic Officer, Elementary Humanities

Susan Lambert

### Content and Editorial

Elizabeth Wade, PhD, Director,  
Elementary Language Arts Content

Patricia Erno, Associate Director, Elementary ELA Instruction

Maria Martinez, Associate Director, Spanish Language Arts

Baria Jennings, EdD, Senior Content Developer

Christina Cox, Managing Editor

### Product and Project Management

Ayala Falk, Director, Business and Product Strategy,  
K-8 Language Arts

Amber McWilliams, Senior Product Manager

Elisabeth Hartman, Associate Product Manager

Catherine Alexander, Senior Project Manager, Spanish Language Arts

LaShon Ormond, SVP, Strategic Initiatives

Leslie Johnson, Associate Director, K-8 Language Arts

Thea Aguiar, Director of Strategic Projects, K-5 Language Arts

Zara Chaudhury, Project Manager, K-8 Language Arts

### Design and Production

Tory Novikova, Product Design Director

Erin O'Donnell, Product Design Manager

### Other Contributors

Patricia Beam, Bill Cheng, Ken Harney, Molly Hensley, David Herubin, Sara Hunt, Kristen Kirchner, James Mendez-Hodes, Christopher Miller, Diana Projansky, Todd Rawson, Jennifer Skelley, Julia Sverchuk, Elizabeth Thiers, Amanda Tolentino, Paige Womack

## Texas Contributors

### Content and Editorial

Sarah Cloos

Laia Cortes

Jayana Desai

Angela Donnelly

Claire Dorfman

Ana Mercedes Falcón

Rebecca Figueroa

Nick García

Sandra de Gennaro

Patricia Infanzón-  
Rodríguez

Seamus Kirst

Michelle Koral

Sean McBride

Jacqueline Ovalle

Sofía Pereson

Lilia Perez

Sheri Pineault

Megan Reasor

Marisol Rodriguez

Jessica Roodvoets

Lyna Ward

### Product and Project Management

Stephanie Koleda

Tamara Morris

### Art, Design, and Production

Nanyamka Anderson

Raghav Arumugan

Dani Aviles

Olioli Buika

Sherry Choi

Stuart Dalgo

Edel Ferri

Pedro Ferreira

Nicole Galuszka

Parker-Nia Gordon

Isabel Hetrick

Ian Horst

Ashna Kapadia

Jagriti Khirwar

Julie Kim

Lisa McGarry

Emily Mendoza

Marguerite Oerlemans

Lucas De Oliveira

Tara Pajouhesh

Jackie Pierson

Dominique Ramsey

Darby Raymond-  
Overstreet

Max Reinhardsen

Mia Saine

Nicole Stahl

Flore Thevoux

Jeanne Thornton

Amy Xu

Jules Zuckerberg



**Amplify.**  
**TEXAS**

ELEMENTARY LITERACY PROGRAM  
LECTOESCRITURA EN ESPAÑOL

**Series Editor-in-Chief**

E. D. Hirsch Jr.

**President**

Linda Bevilacqua

**Editorial Staff**

Mick Anderson  
Robin Blackshire  
Laura Drummond  
Emma Earnst  
Lucinda Ewing  
Sara Hunt  
Rosie McCormick  
Cynthia Peng  
Liz Pettit  
Tonya Ronayne  
Deborah Samley  
Kate Stephenson  
Elizabeth Wafler  
James Walsh  
Sarah Zelinke

**Design and Graphics Staff**

Kelsie Harman  
Liz Loewenstein  
Bridget Moriarty  
Lauren Pack

**Consulting Project Management Services**

ScribeConcepts.com

**Additional Consulting Services**

Erin Kist  
Carolyn Pinkerton  
Scott Ritchie  
Kelina Summers

**Acknowledgments**

These materials are the result of the work, advice, and encouragement of numerous individuals over many years. Some of those singled out here already know the depth of our gratitude; others may be surprised to find themselves thanked publicly for help they gave quietly and generously for the sake of the enterprise alone. To helpers named and unnamed we are deeply grateful.

**Contributors to Earlier Versions of These Materials**

Susan B. Albaugh, Kazuko Ashizawa, Kim Berrall, Ang Blanchette, Nancy Braier, Maggie Buchanan, Paula Coyner, Kathryn M. Cummings, Michelle De Groot, Michael Donegan, Diana Espinal, Mary E. Forbes, Michael L. Ford, Sue Fulton, Carolyn Gosse, Dorrit Green, Liza Greene, Ted Hirsch, Danielle Knecht, James K. Lee, Matt Leech, Diane Henry Leipzig, Robin Luecke, Martha G. Mack, Liana Mahoney, Isabel McLean, Steve Morrison, Juliane K. Munson, Elizabeth B. Rasmussen, Ellen Sadler, Rachael L. Shaw, Sivan B. Sherman, Diane Auger Smith, Laura Tortorelli, Khara Turnbull, Miriam E. Vidaver, Michelle L. Warner, Catherine S. Whittington, Jeannette A. Williams.

We would like to extend special recognition to Program Directors Matthew Davis and Souzanne Wright, who were instrumental in the early development of this program.

**Schools**

We are truly grateful to the teachers, students, and administrators of the following schools for their willingness to field-test these materials and for their invaluable advice: Capitol View Elementary, Challenge Foundation Academy (IN), Community Academy Public Charter School, Lake Lure Classical Academy, Lepanto Elementary School, New Holland Core Knowledge Academy, Paramount School of Excellence, Pioneer Challenge Foundation Academy, PS 26R (the Carteret School), PS 30X (Wilton School), PS 50X (Clara Barton School), PS 96Q, PS 102X (Joseph O. Loretan), PS 104Q (the Bays Water), PS 214K (Michael Friedsam), PS 223Q (Lyndon B. Johnson School), PS 308K (Clara Cardwell), PS 333Q (Goldie Maple Academy), Sequoyah Elementary School, South Shore Charter Public School, Spartanburg Charter School, Steed Elementary School, Thomas Jefferson Classical Academy, Three Oaks Elementary, West Manor Elementary.

And a special thanks to the Pilot Coordinators, Anita Henderson, Yasmin Lugo-Hernandez, and Susan Smith, whose suggestions and day-to-day support to teachers using these materials in their classrooms were critical.



## Credits

Every effort has been taken to trace and acknowledge copyrights. The editors tender their apologies for any accidental infringement where copyright has proved untraceable. They would be pleased to insert the appropriate acknowledgment in any subsequent edition of this publication. Trademarks and trade names are shown in this publication for illustrative purposes only and are the property of their respective owners. The references to trademarks and trade names given herein do not affect their validity.

All photographs are used under license from Shutterstock, Inc. unless otherwise noted.

## Illustrators and Image Sources

10: Staff; 11: Staff; 13: Staff; 20: Staff; 23: Staff; 28: Staff; 30: Staff; 32: Staff; 39: Staff; 40: Staff; 42: Staff; 49: Staff; 52: Staff; 58: Staff; 60: Staff; 67: Staff; 69: Staff; 75: Staff; 77: Staff; 84: Staff; 86: Staff; 93: Staff; 104: Staff; 116: Staff; 117: Staff; 118: Staff; 119: Staff; 120: Staff; 121: Staff; TR 1.1: Staff; TR 1.2: Staff; TR 2.1: Staff; TR 3.1: Staff; TR 3.2: Shutterstock; TR 4.1: Staff; TR 4.2: Shutterstock; TR 5.1: Barbara Gibson; TR 5.2: Shutterstock; TR 6.1: Shutterstock; TR 8.1: Staff; TR 10.1: Staff; 3.2: Staff; 4.2: Staff; 4.3: Staff; 10.3: Shutterstock, Staff; PP.10: Staff; PP.12: Staff; 145: Staff; 164: Staff

Regarding the Shutterstock items listed above, please note: "No person or entity shall falsely represent, expressly or by way of reasonable implication, that the content herein was created by that person or entity, or any person other than the copyright holder(s) of that content."



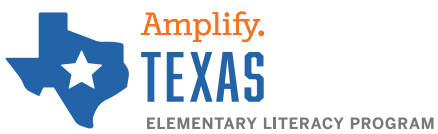

**Kindergarten | Skills 2 |** Teacher Guide

ISBN 9781683919193



9 781683 919193

2

Kindergarten

**Skills 2** | Activity Book

Kindergarten

---

## **Skills 2**

---

**Activity Book**

**Notice and Disclaimer:** The agency has developed these learning resources as a contingency option for school districts. These are optional resources intended to assist in the delivery of instructional materials in this time of public health crisis. Feedback will be gathered from educators and organizations across the state and will inform the continuous improvement of subsequent units and editions. School districts and charter schools retain the responsibility to educate their students and should consult with their legal counsel regarding compliance with applicable legal and constitutional requirements and prohibitions.

Given the timeline for development, errors are to be expected. If you find an error, please email us at **[texashomelearning@tea.texas.gov](mailto:texashomelearning@tea.texas.gov)**.

ISBN 978-1-64383-781-9

This work is licensed under a Creative Commons Attribution-NonCommercial-ShareAlike 4.0 International License.

You are free:

to Share—to copy, distribute, and transmit the work

to Remix—to adapt the work

Under the following conditions:

**Attribution**—You must attribute any adaptations of the work in the following manner:

This work is based on original works of Amplify Education, Inc. ([amplify.com](http://amplify.com)) and the Core Knowledge Foundation ([coreknowledge.org](http://coreknowledge.org)) made available under a Creative Commons Attribution-NonCommercial-ShareAlike 4.0 International License. This does not in any way imply endorsement by those authors of this work.

**Noncommercial**—You may not use this work for commercial purposes.

**Share Alike**—If you alter, transform, or build upon this work, you may distribute the resulting work only under the same or similar license to this one.

With the understanding that:

For any reuse or distribution, you must make clear to others the license terms of this work. The best way to do this is with a link to this web page:

**<https://creativecommons.org/licenses/by-nc-sa/4.0/>**

© 2020 Amplify Education, Inc.  
**[amplify.com](http://amplify.com)**

Trademarks and trade names are shown in this book strictly for illustrative and educational purposes and are the property of their respective owners. References herein should not be regarded as affecting the validity of said trademarks and trade names.

Printed in Mexico  
01 XXX 2021

# **Skills 2**

## **Activity Book**

This Activity Book contains activity pages that accompany many of the lessons from the Teacher Guide for Unit 2. The activity pages are organized and numbered according to the lesson number and the order in which they are used within the lesson. For example, if there are two activity pages for Lesson 4, the first will be numbered 4.1 and the second 4.2. The activity pages in this book do not include written instructions for students because the instructions would have words that are not decodable. Teachers will explain these activity pages to the students orally, using the instructions in the Teacher Guide. The Activity Book is a student component, which means each student should have an Activity Book.





NAME: \_\_\_\_\_

DATE: \_\_\_\_\_

1.1

Directions: Ask students to simultaneously name and point to the pictures in each row from left to right. Students should work through the pictures in the top row, then the second row, then the third row, and then the bottom row.

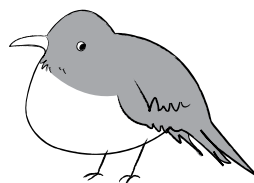
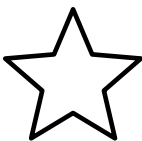
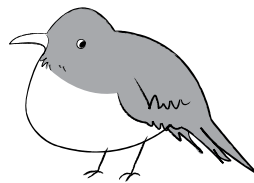
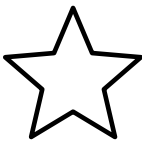
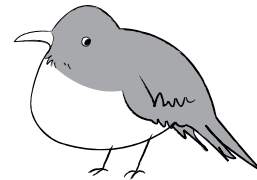
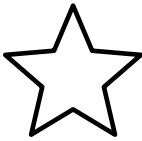
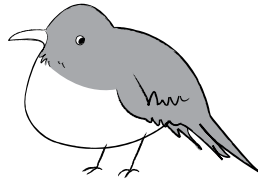
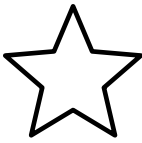

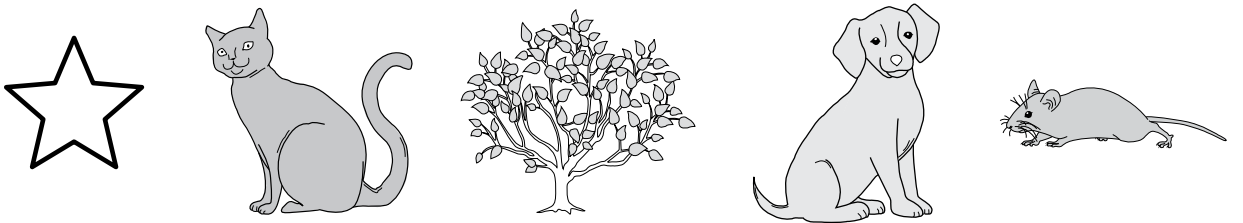
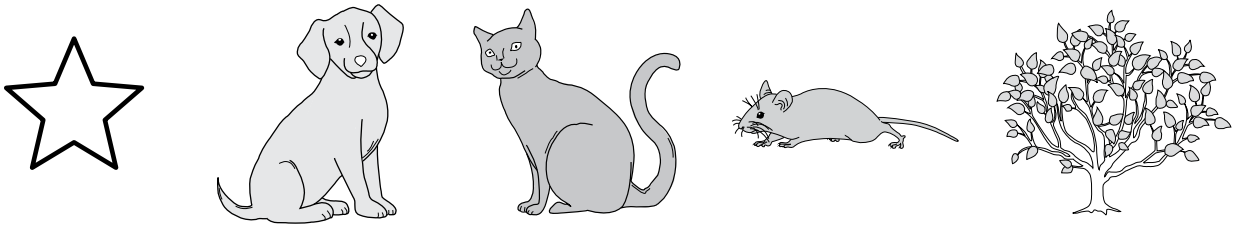
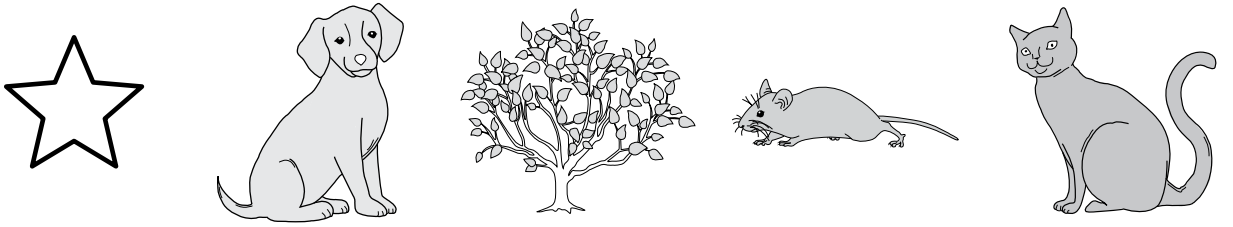

NAME: \_\_\_\_\_

DATE: \_\_\_\_\_

1.2

Directions: Ask students to trace the dotted cups, starting at the stars.





NAME: \_\_\_\_\_

DATE: \_\_\_\_\_

1.3

Take-Home

**Dear Family Member,**

In class, we have been practicing cup shapes. This is one of several simple shapes we are practicing for letter formation. Please have your child trace the dotted cups on the front and back of this activity page, starting at the stars. Students may color the pictures after they complete tracing (optional).

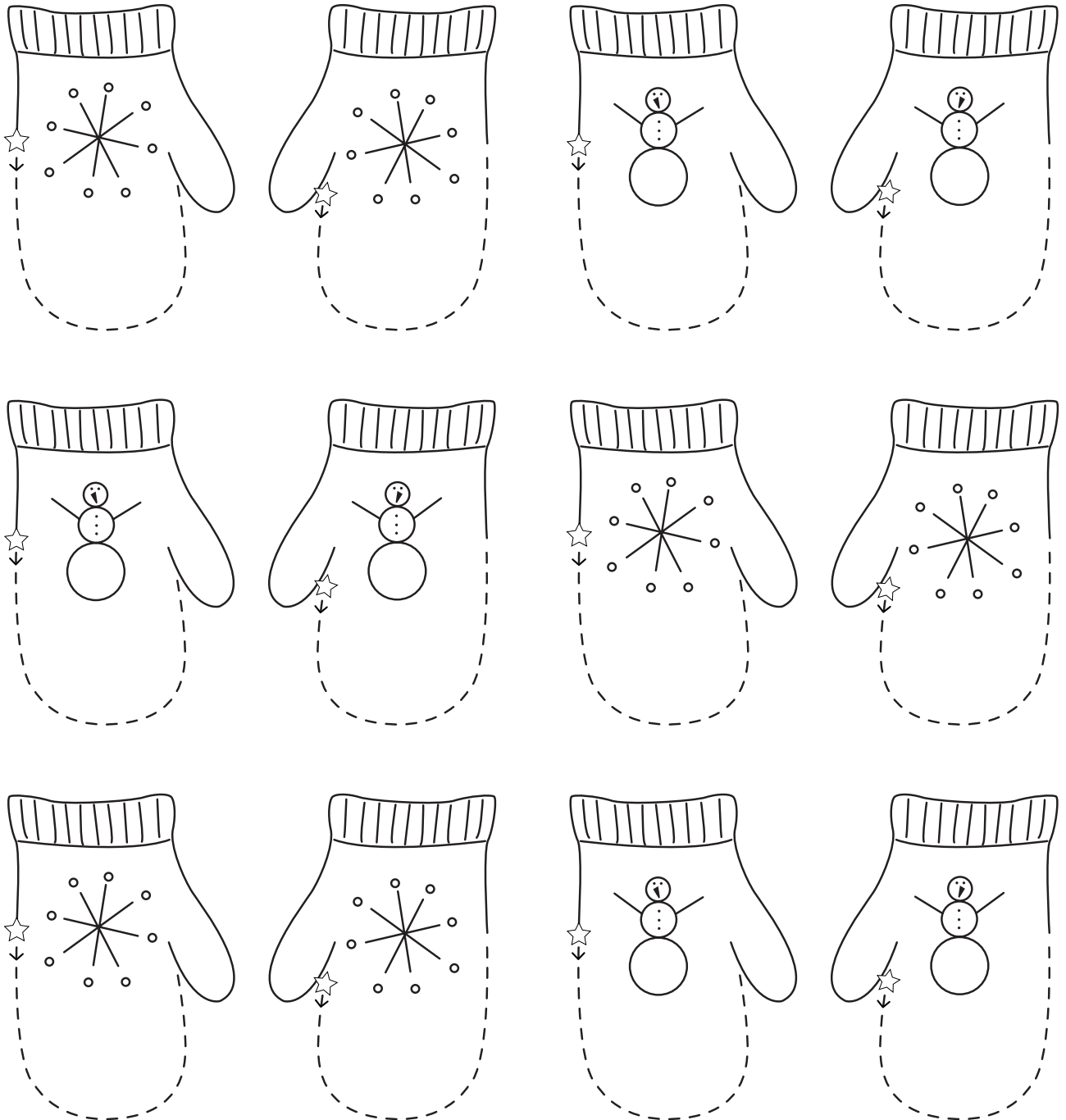

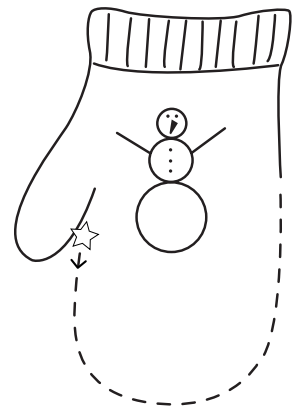
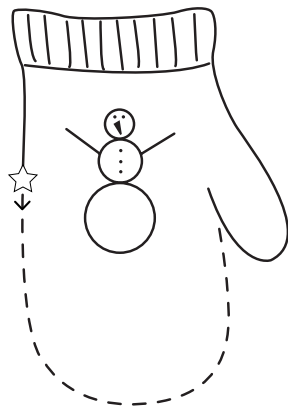
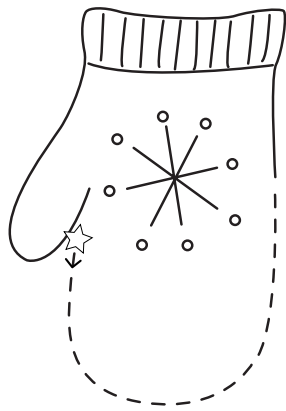
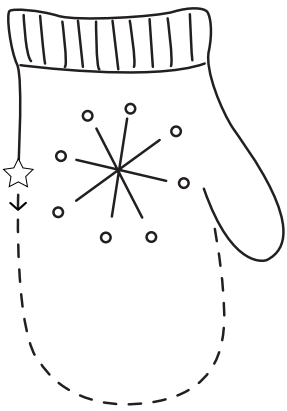
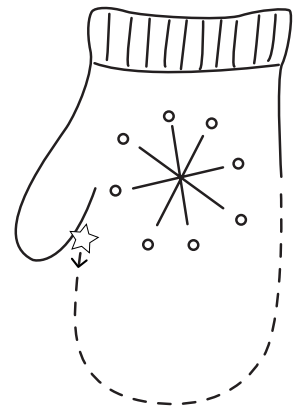
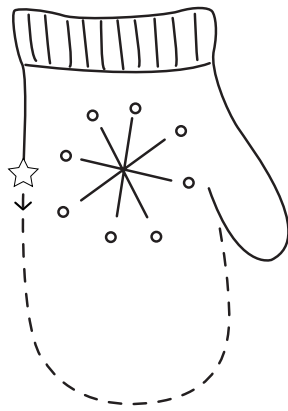
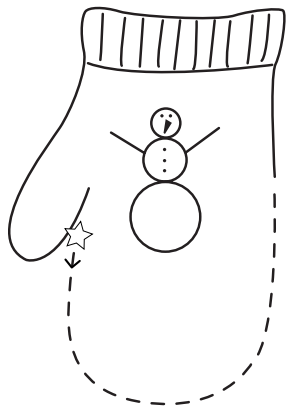
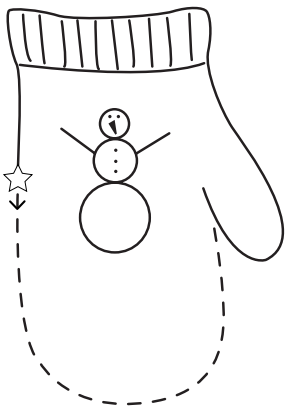
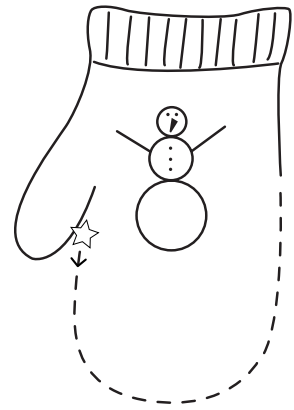
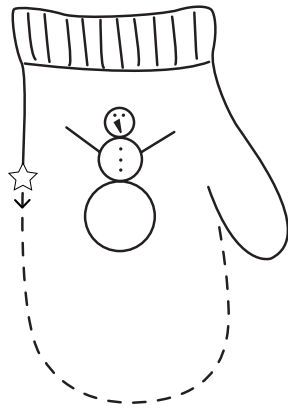
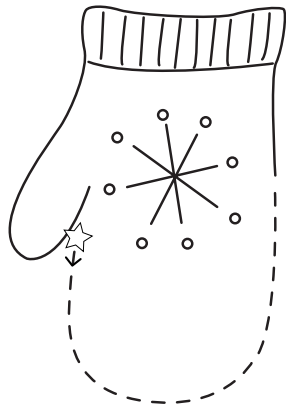
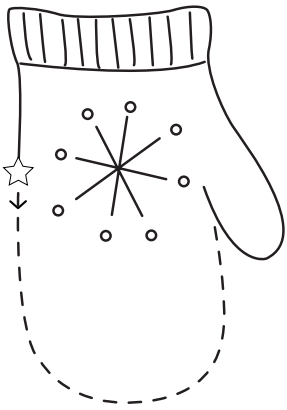
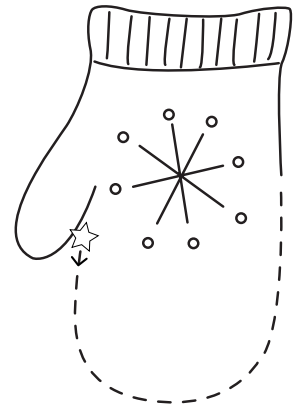
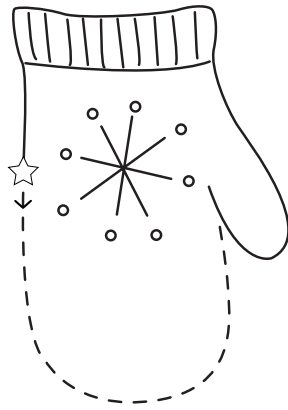
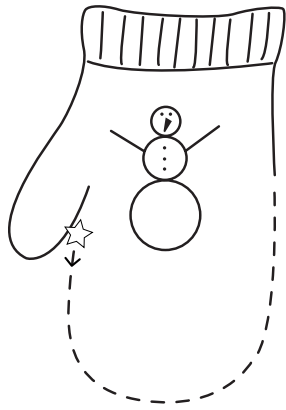
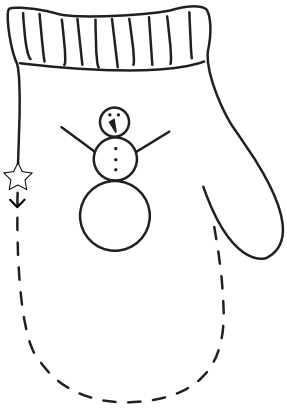

NAME: \_\_\_\_\_

DATE: \_\_\_\_\_

2.1

Activity Page

Directions: Ask students to trace the dotted humps, starting at the stars. Students may color the picture (optional).

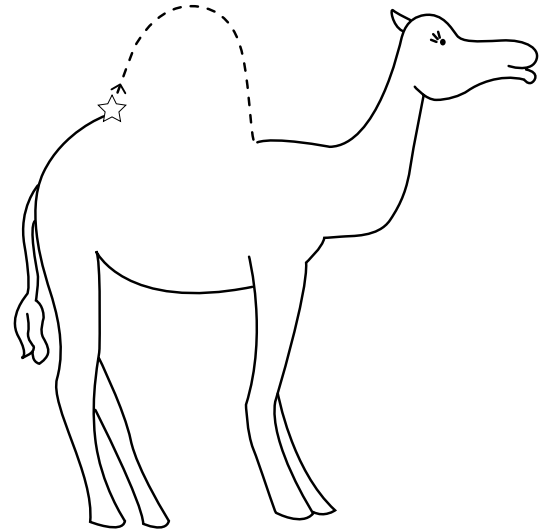
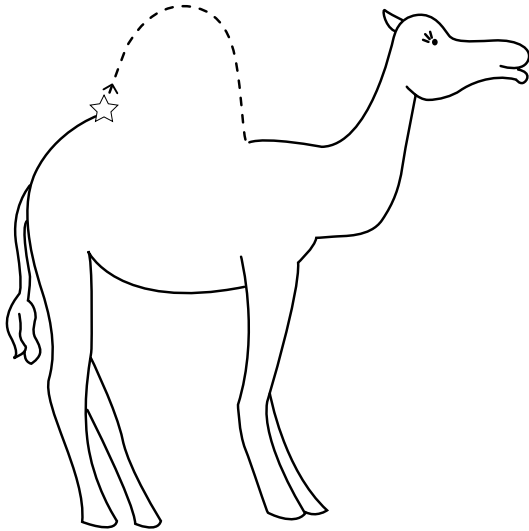
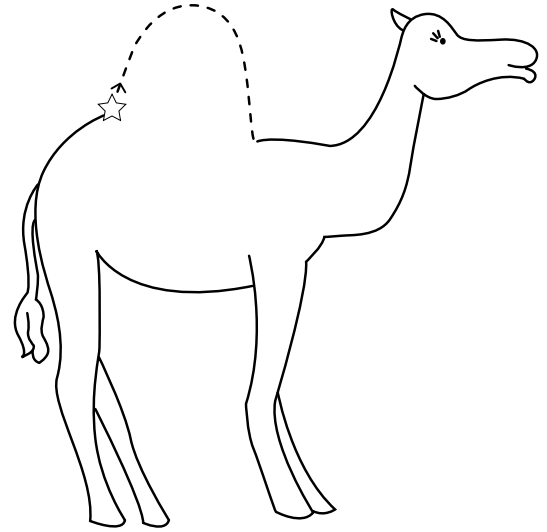
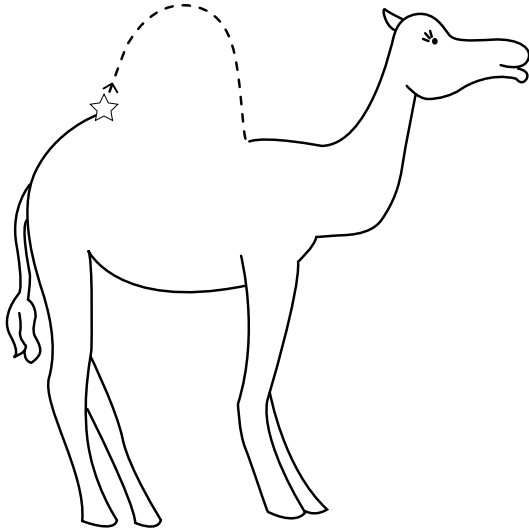
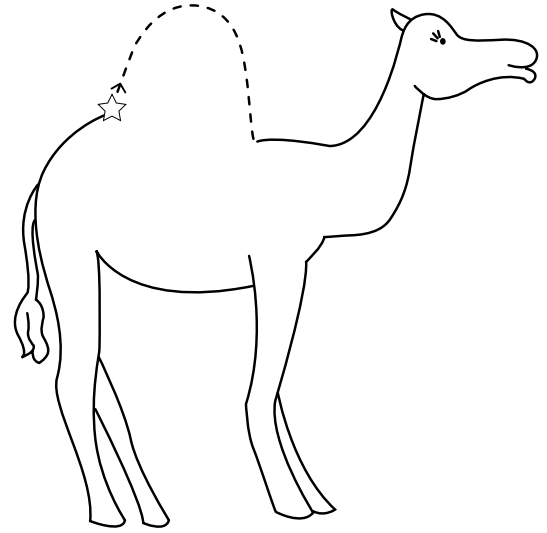
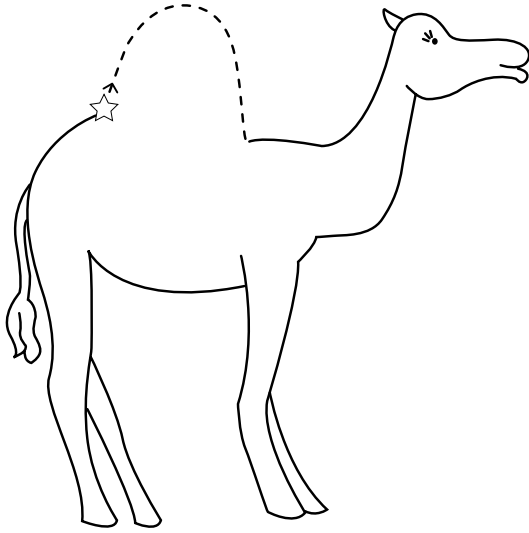

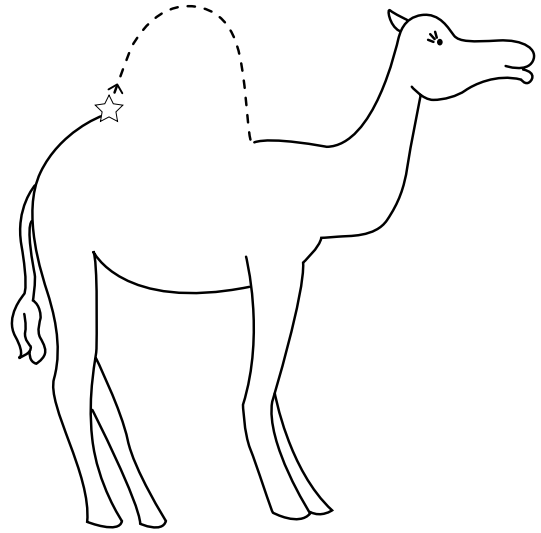
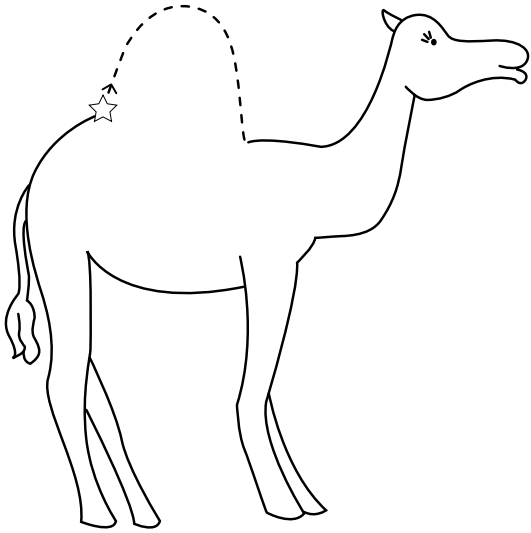
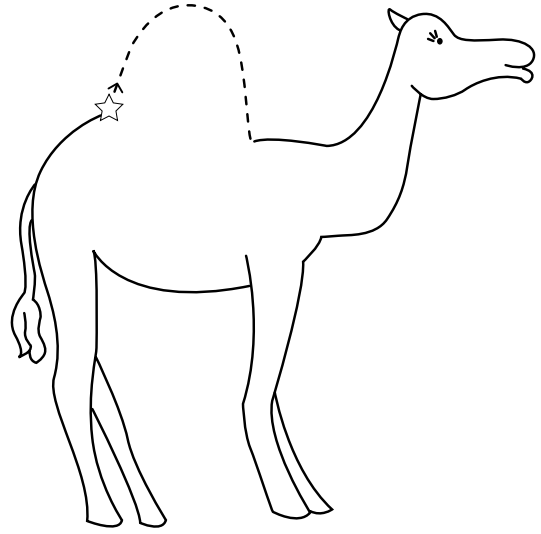
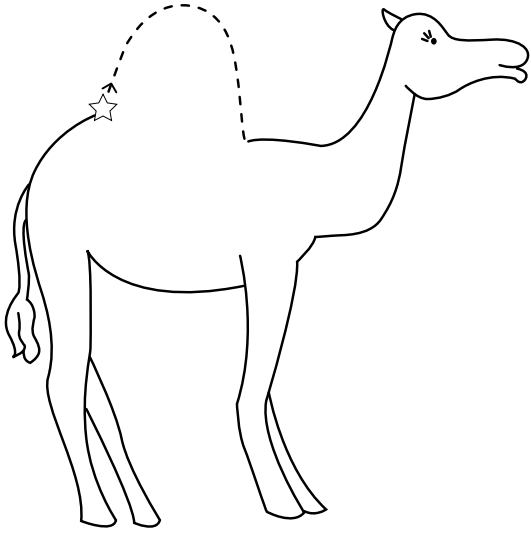
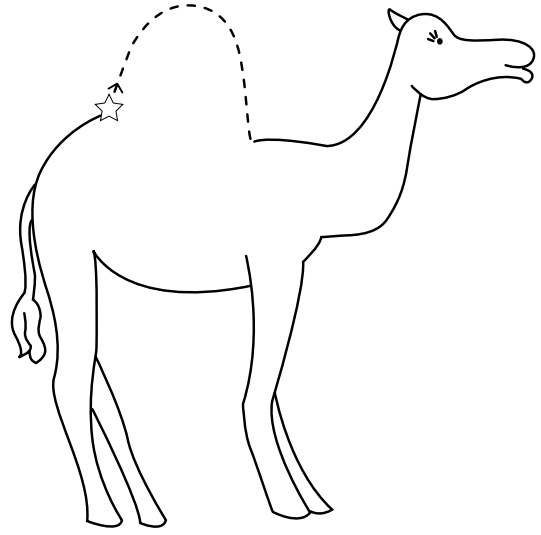
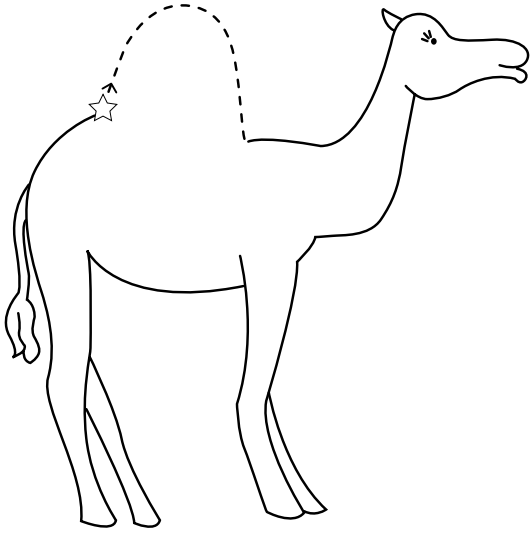



NAME: \_\_\_\_\_

DATE: \_\_\_\_\_

2.2

Take-Home

**Dear Family Member,**

In class, we have been practicing hump shapes. This is one of several simple shapes we are practicing for letter formation. Please have your child trace the dotted humps on the front and back of this activity page, starting at the stars.

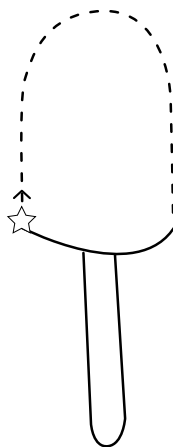
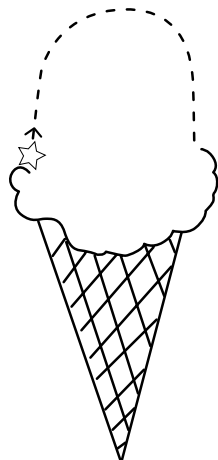
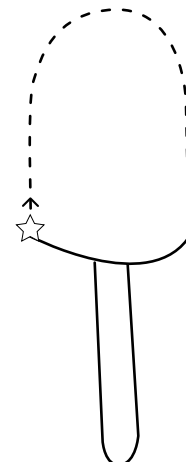
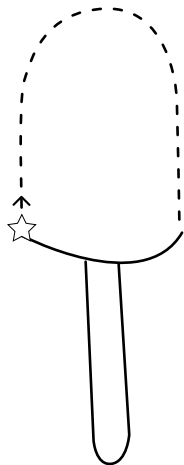
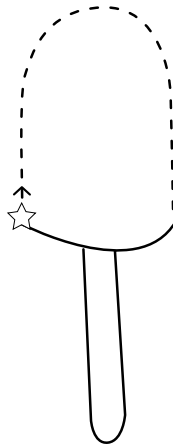
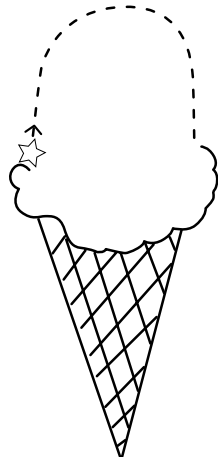

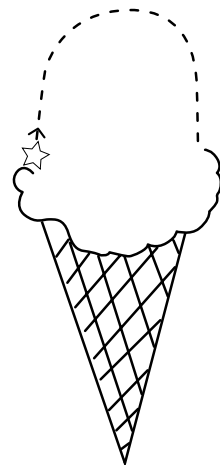
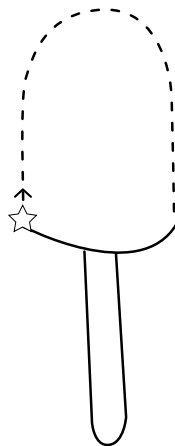
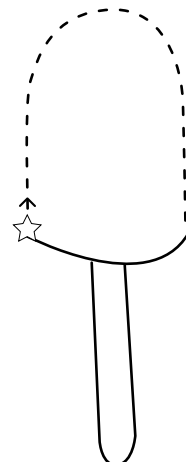
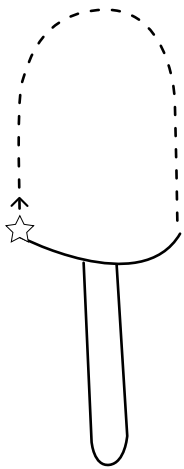
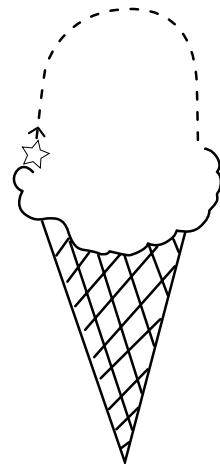
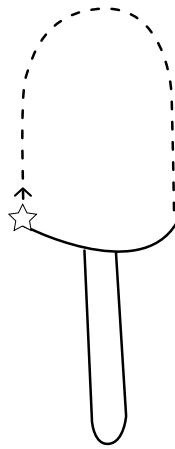

NAME: \_\_\_\_\_

DATE: \_\_\_\_\_

Directions: Ask students to trace the dotted zigzags, starting at the stars.

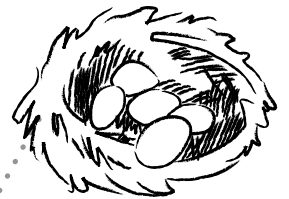
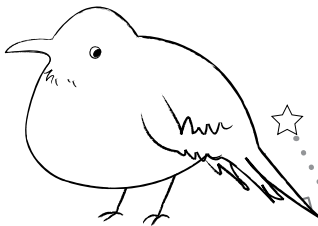
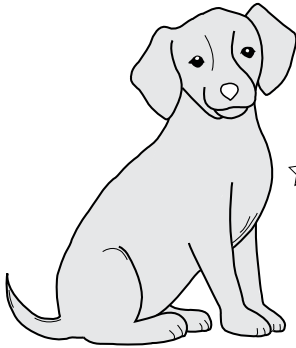
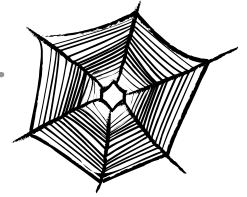
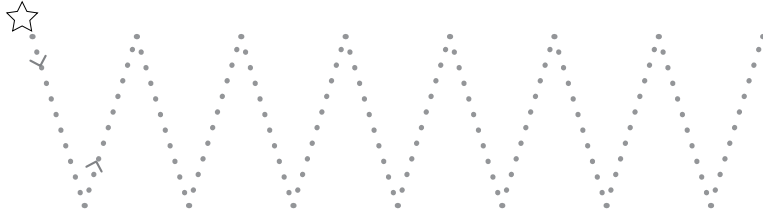
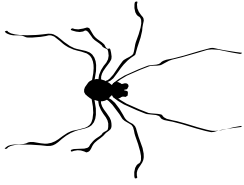
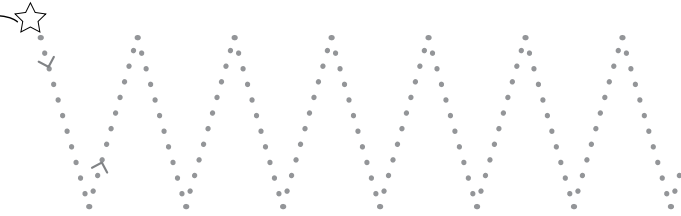
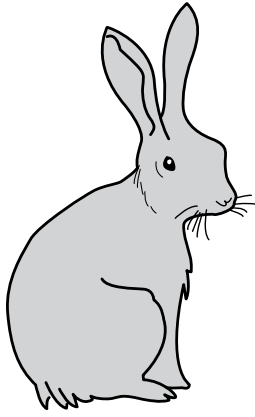

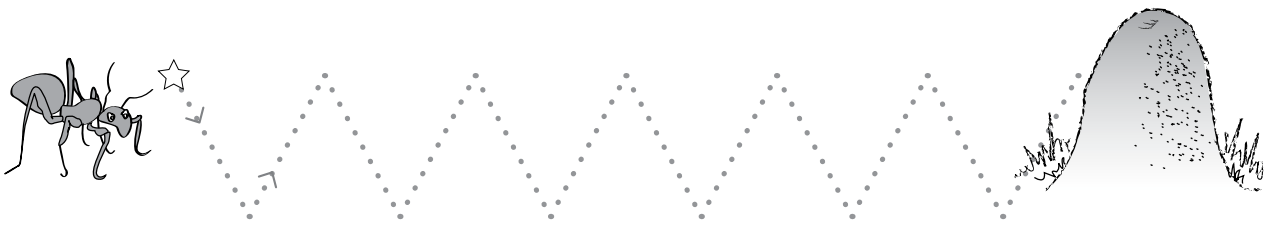







NAME: \_\_\_\_\_

DATE: \_\_\_\_\_

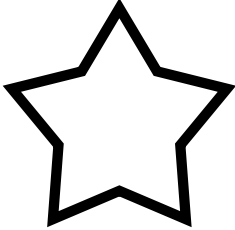
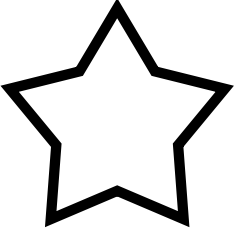
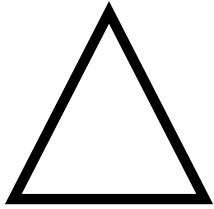
3.2

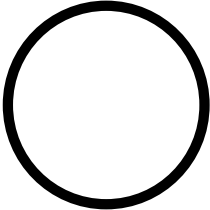
Activity Page

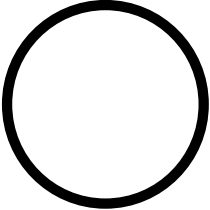
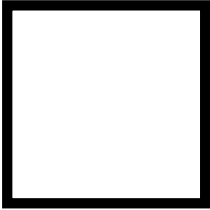
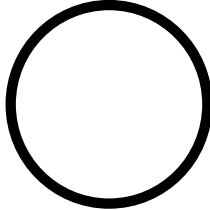
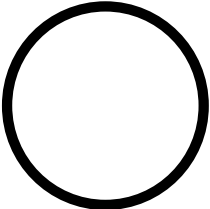
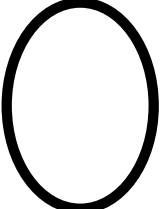
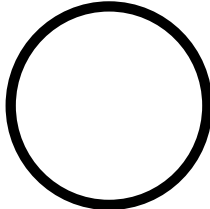
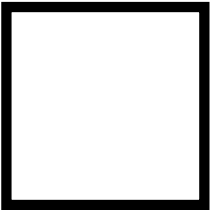
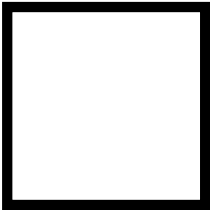
Directions: For each row, have students circle the shape that is the same as the shape on the left and cross out the shape that is different.

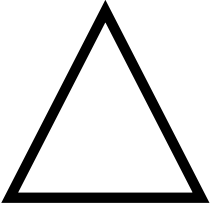
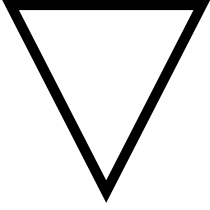
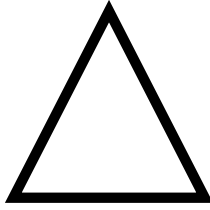
|                                                                                     |                                                                                      |                                                                                       |
|-------------------------------------------------------------------------------------|--------------------------------------------------------------------------------------|---------------------------------------------------------------------------------------|
|    |    |    |
|    |    |    |
|   |   |   |
|  |  |  |
|  |  |  |
|  |  |  |

|   |   |   |
|---|---|---|
| V | W | V |
| C | C | Ɔ |
| S | Z | S |
| T | I | T |
| W | M | W |
| F | E | F |

NAME: \_\_\_\_\_











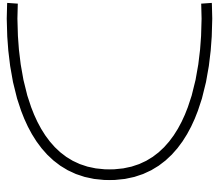

DATE: \_\_\_\_\_

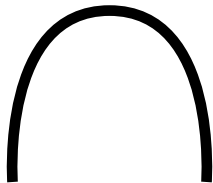
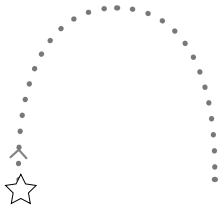
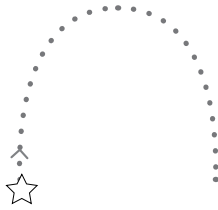
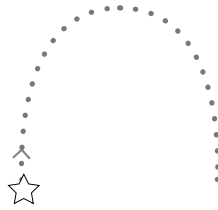













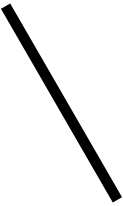



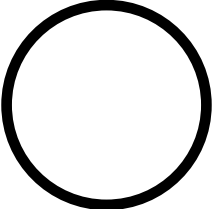

3.3

Take-Home

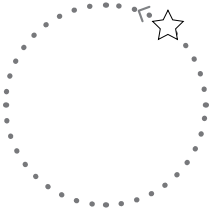
**Dear Family Member,**

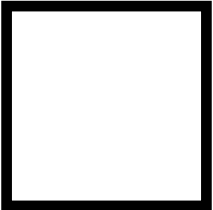
On the front and back of this activity page are a number of simple shapes we are practicing for letter formation. Please have your child trace the dotted shapes, starting at the stars.

|                                                                                     |                                                                                     |                                                                                       |                                                                                       |
|-------------------------------------------------------------------------------------|-------------------------------------------------------------------------------------|---------------------------------------------------------------------------------------|---------------------------------------------------------------------------------------|
|    |    |     |    |
|    |    |     |    |
|  |  |   |  |
|  |  |  |  |

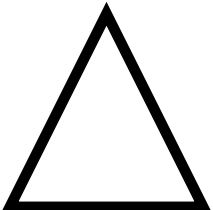
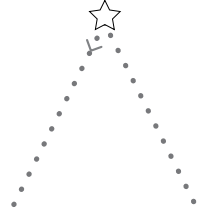
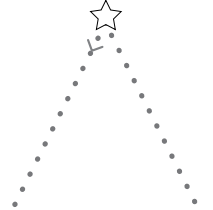
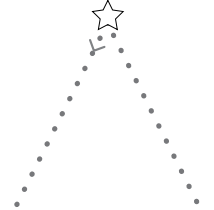
|                                                                                     |                                                                                     |                                                                                      |                                                                                       |
|-------------------------------------------------------------------------------------|-------------------------------------------------------------------------------------|--------------------------------------------------------------------------------------|---------------------------------------------------------------------------------------|
|    |    |    |    |
|    |    |    |    |
|   |   |   |   |
|  |  |  |  |
|  |  |  |  |
|  |  |  |  |



NAME: \_\_\_\_\_

DATE: \_\_\_\_\_

4.1

Activity Page

Directions: Ask students to trace the dotted wavy lines, starting at the stars.

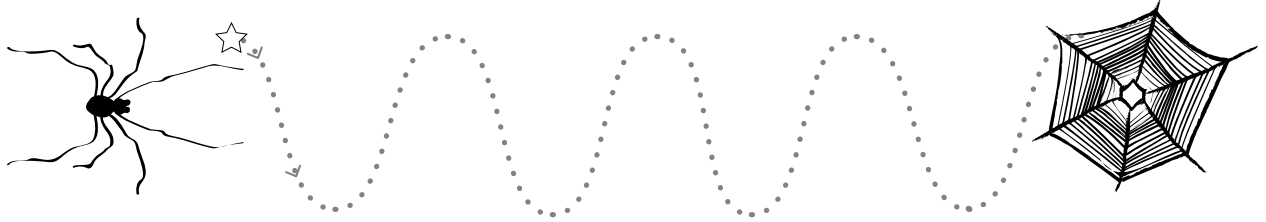
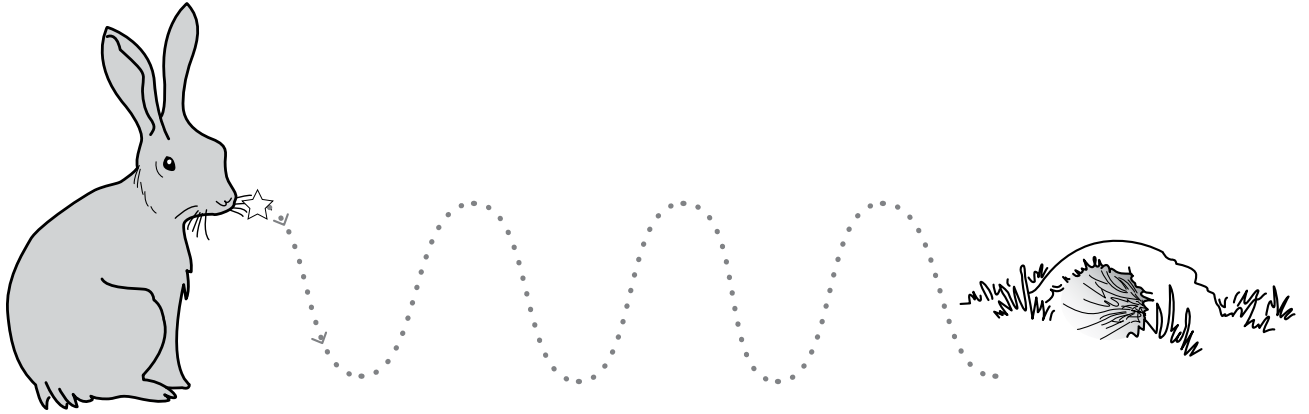

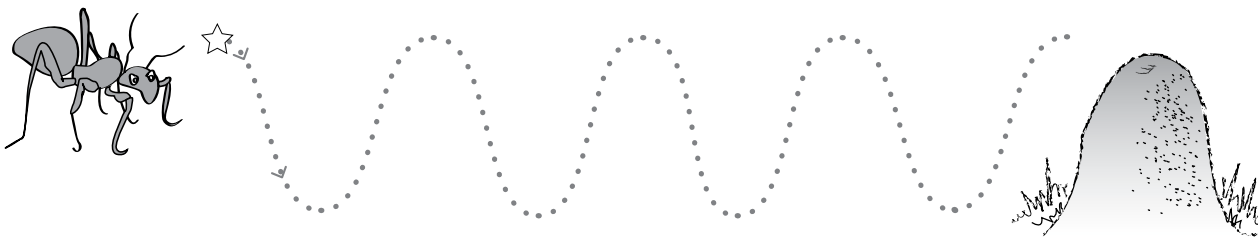
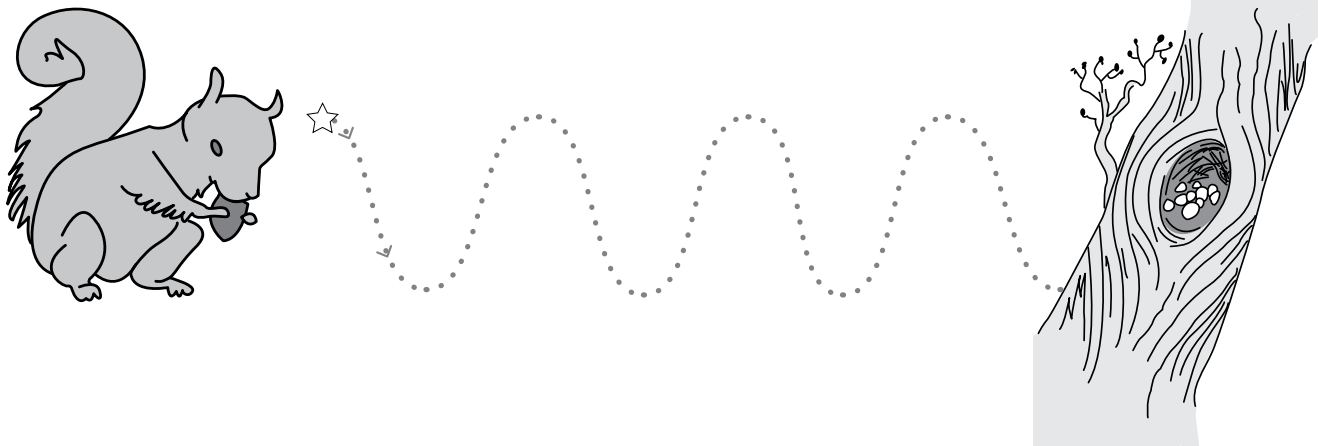
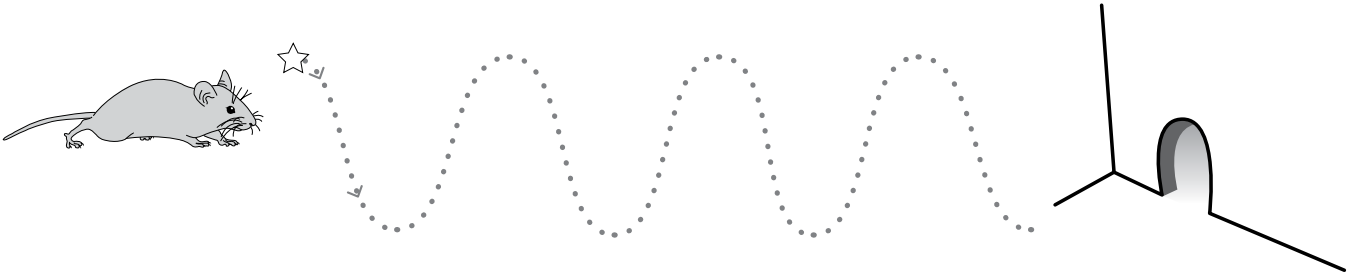

NAME: \_\_\_\_\_

DATE: \_\_\_\_\_

4.2

Activity Page

Directions: For each row, ask students to color the shape that is at the beginning green and the shape that is at the end red.

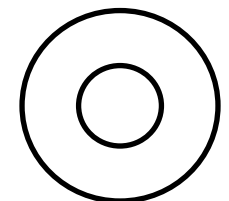
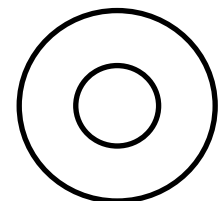
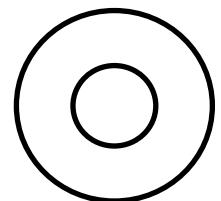
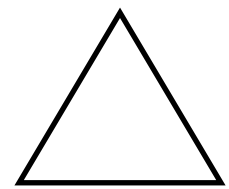
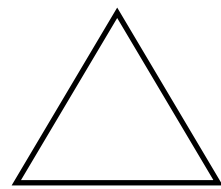
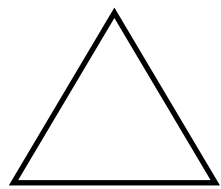
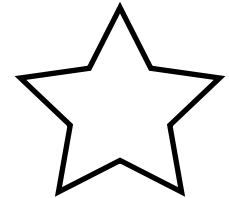
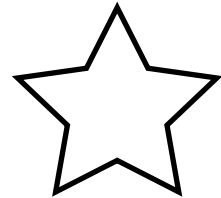
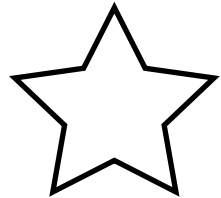
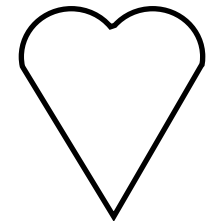
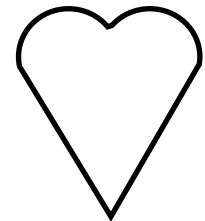
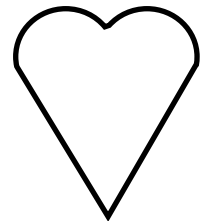
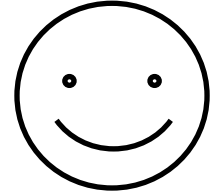
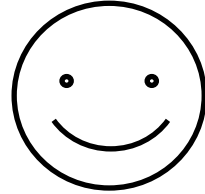
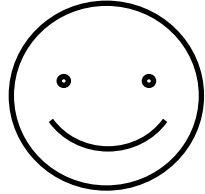



NAME: \_\_\_\_\_











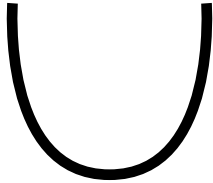

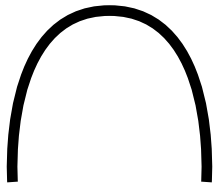

DATE: \_\_\_\_\_







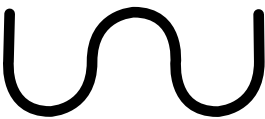







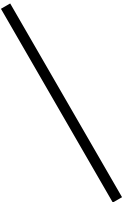



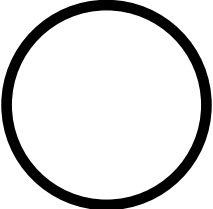

4.3

Take-Home

**Dear Family Member,**

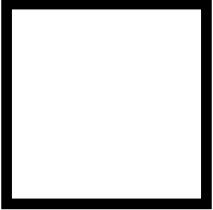
On the front and back of this activity page are a number of simple shapes we are practicing for letter formation. Please have your child trace the dotted shapes, starting at the stars.

|                                                                                     |                                                                                      |                                                                                      |                                                                                       |
|-------------------------------------------------------------------------------------|--------------------------------------------------------------------------------------|--------------------------------------------------------------------------------------|---------------------------------------------------------------------------------------|
|    |     |    |    |
|    |     |    |    |
|  |   |  |  |
|  |  |                                                                                      |                                                                                       |

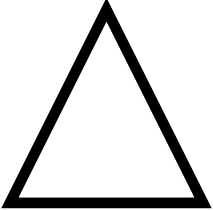
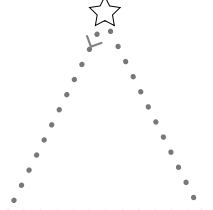
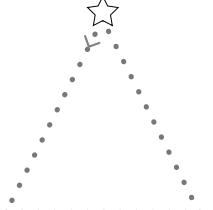
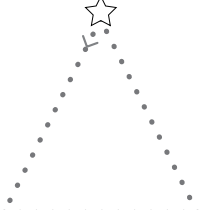
|                                                                                     |                                                                                     |                                                                                      |                                                                                       |
|-------------------------------------------------------------------------------------|-------------------------------------------------------------------------------------|--------------------------------------------------------------------------------------|---------------------------------------------------------------------------------------|
|    |    |    |    |
|    |    |    |    |
|   |   |   |   |
|  |  |  |  |
|  |  |  |  |
|  |  |  |  |

NAME: \_\_\_\_\_

DATE: \_\_\_\_\_

5.1

Activity Page

Directions: Ask students to trace the dotted spirals, starting at the stars. Students may color the picture (optional).

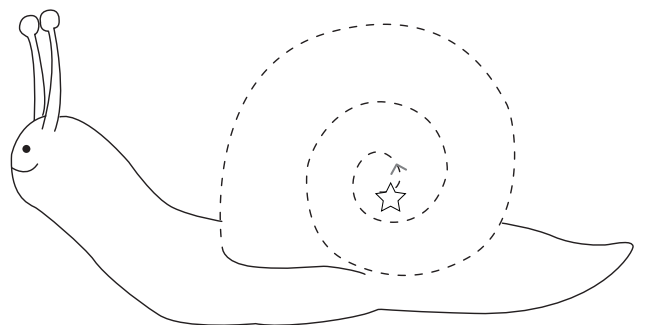
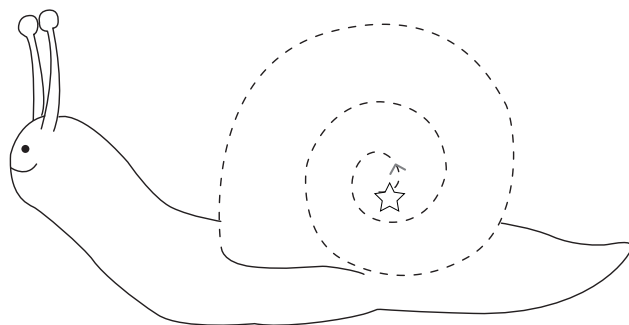
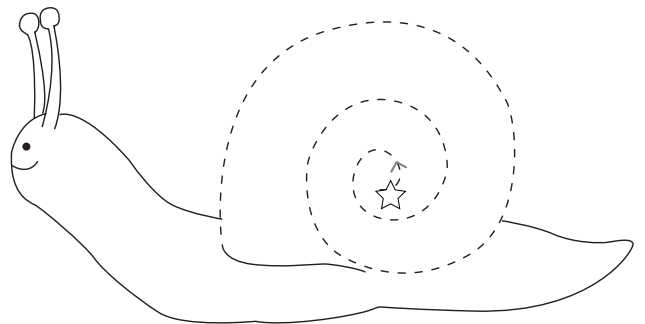
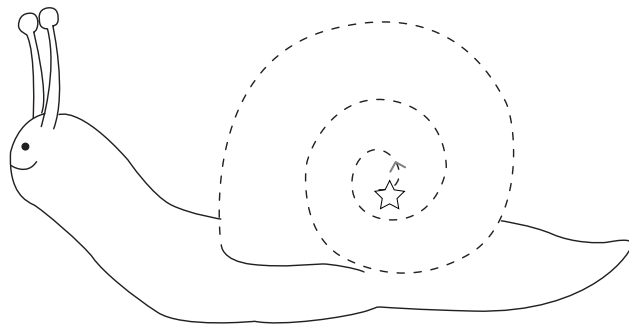
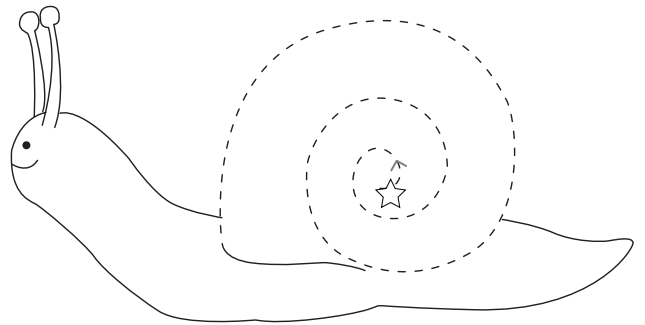
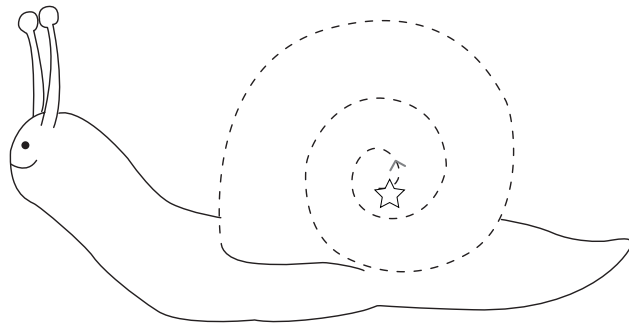
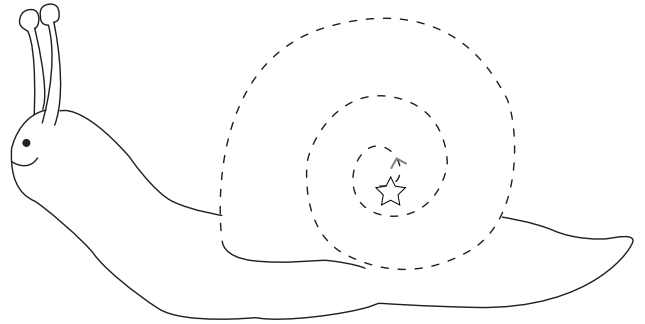
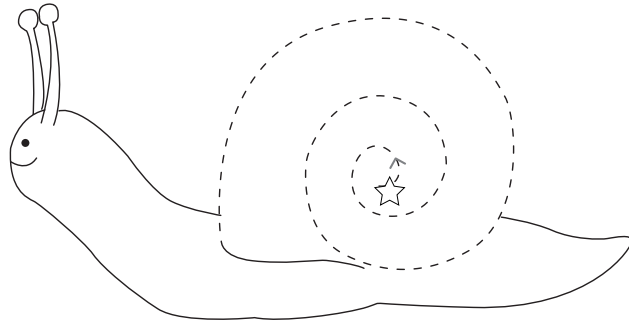

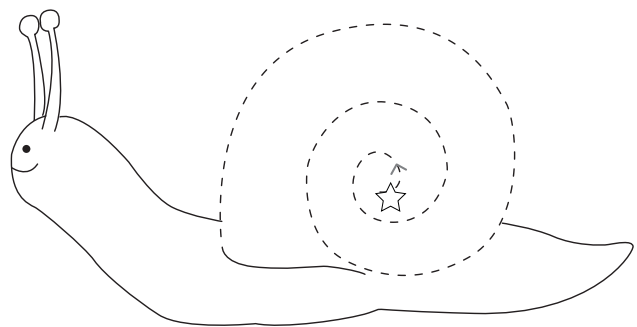
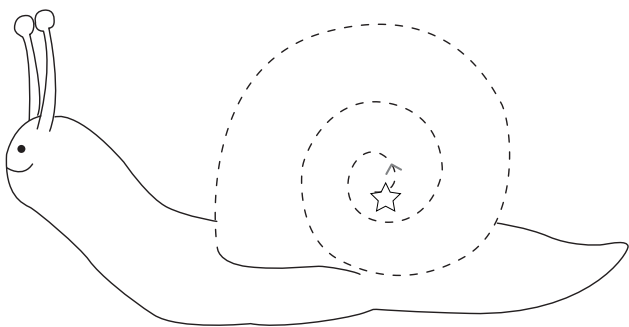
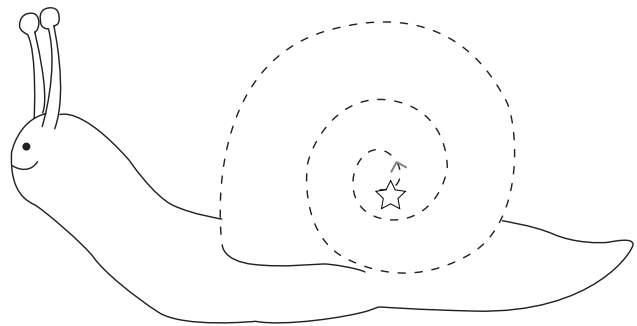
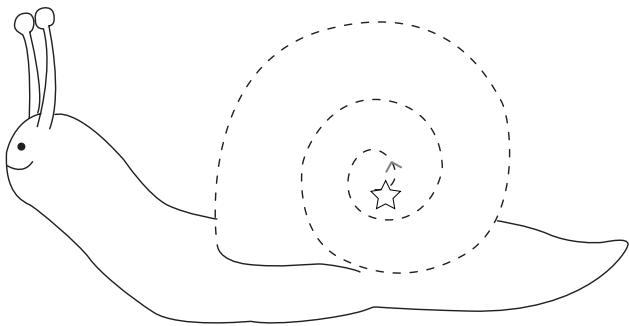
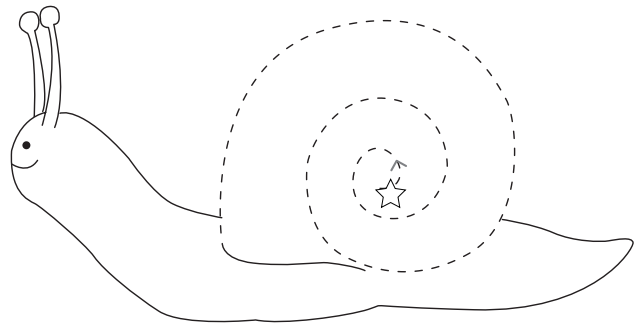
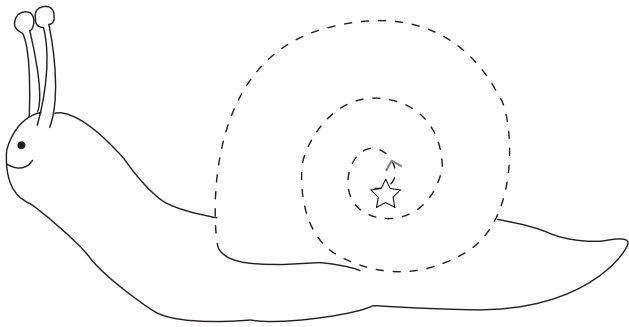
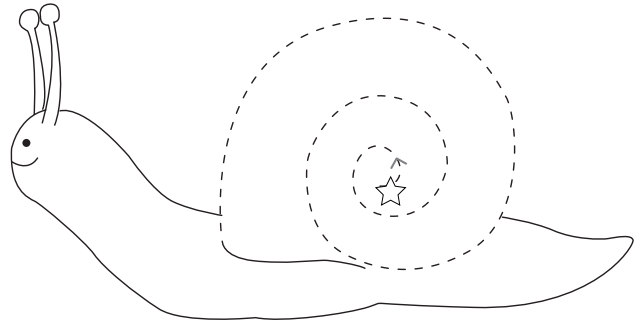
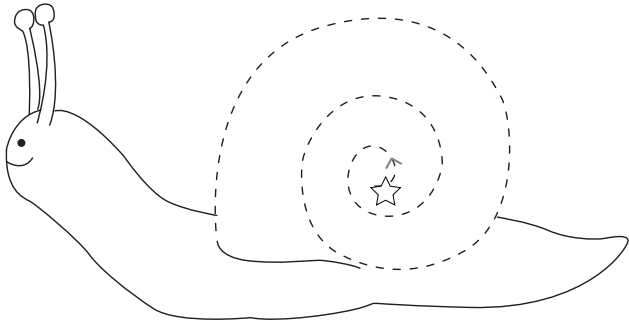



NAME: \_\_\_\_\_









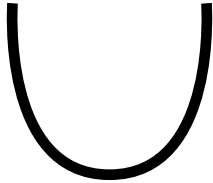

DATE: \_\_\_\_\_



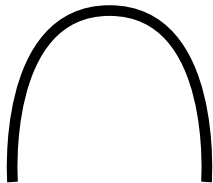
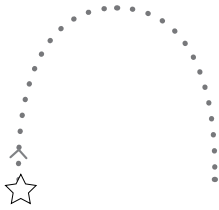
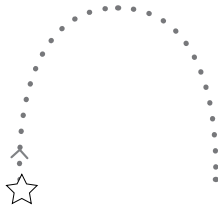
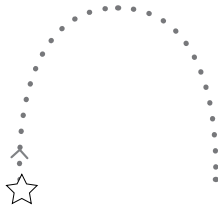







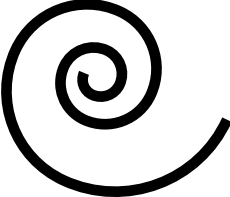
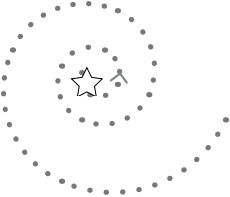
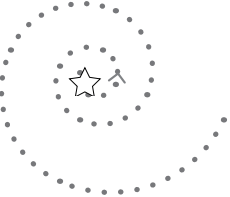





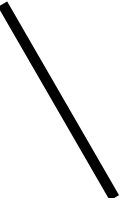

5.2

Take-Home

**Dear Family Member,**

On the front and back of this activity page are a number of simple shapes we are practicing for letter formation. Please have your child trace the dotted shapes, starting at the stars.

|                                                                                     |                                                                                      |                                                                                      |                                                                                       |
|-------------------------------------------------------------------------------------|--------------------------------------------------------------------------------------|--------------------------------------------------------------------------------------|---------------------------------------------------------------------------------------|
|    |     |    |    |
|    |     |    |    |
|  |   |  |  |
|  |  |                                                                                      |                                                                                       |

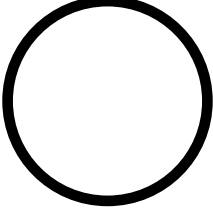
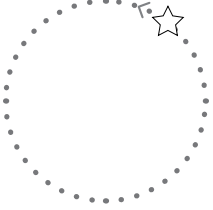
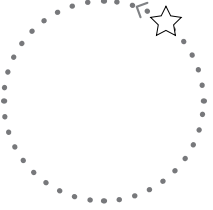
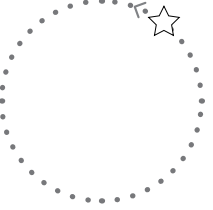
|                                                                                     |                                                                                     |                                                                                      |                                                                                       |
|-------------------------------------------------------------------------------------|-------------------------------------------------------------------------------------|--------------------------------------------------------------------------------------|---------------------------------------------------------------------------------------|
|    |    |    |    |
|    |    |     |    |
|    |    |    |    |
|  |  |  |  |
|  |  |  |  |
|  |  |  |  |

NAME: \_\_\_\_\_

DATE: \_\_\_\_\_

6.1

Activity Page

Directions: Ask students to trace the dotted shapes, starting each line at a star.

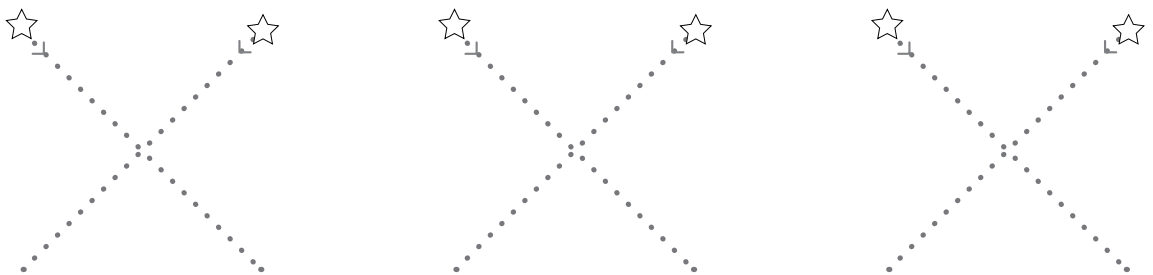
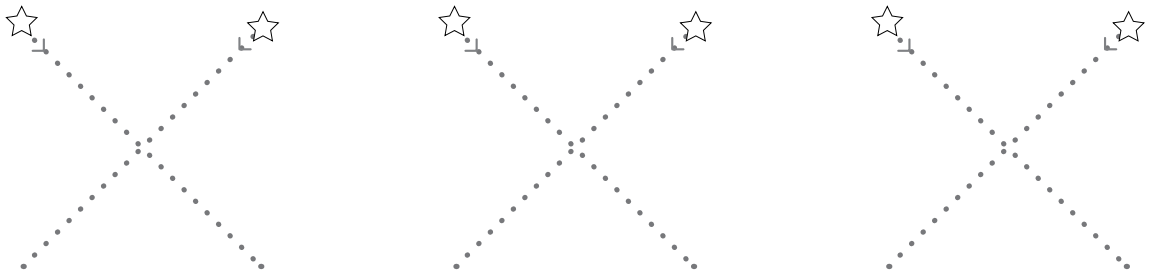
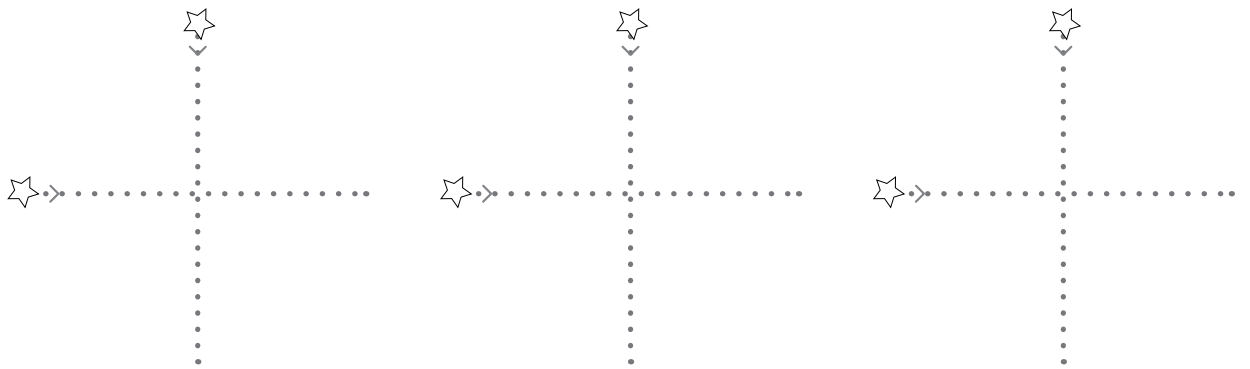
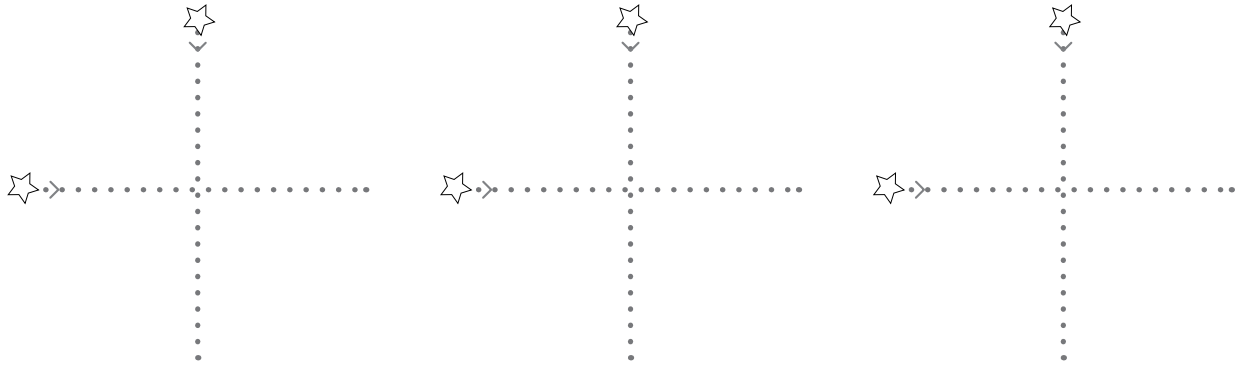

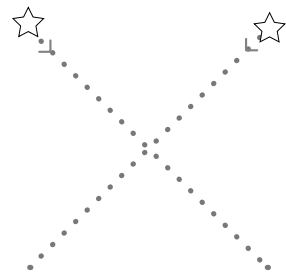
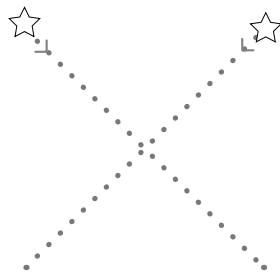
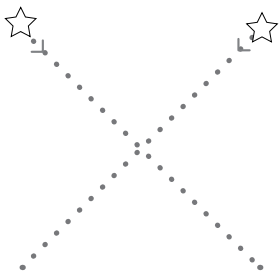
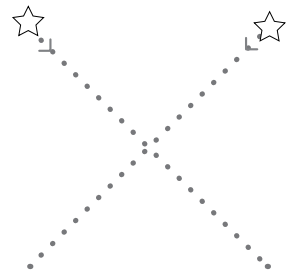
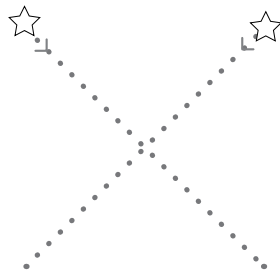
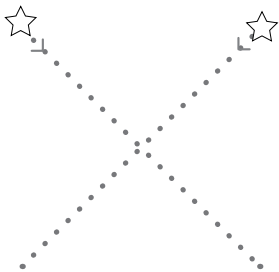
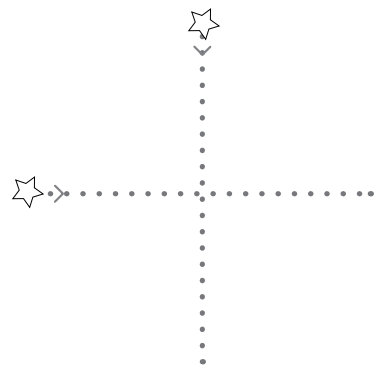
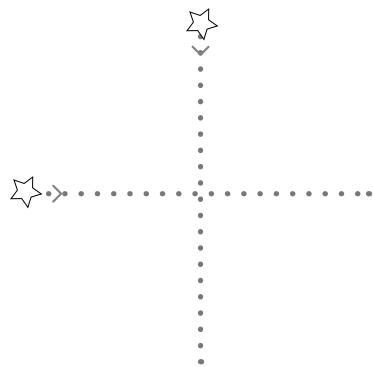
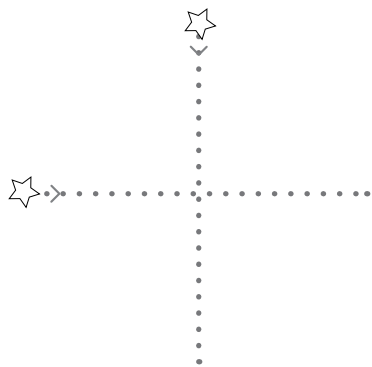
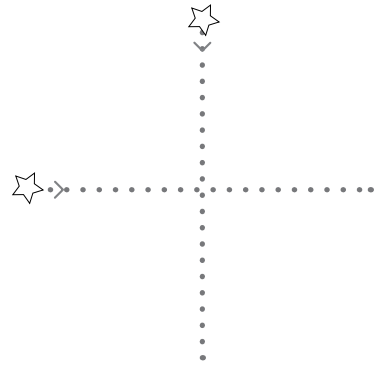
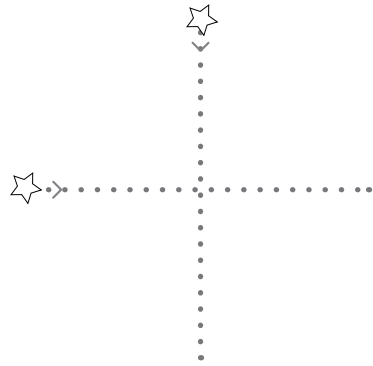
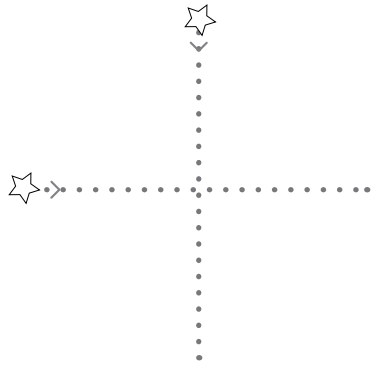

NAME: \_\_\_\_\_

DATE: \_\_\_\_\_

6.2

Take-Home

**Dear Family Member,**

In class, we have been practicing **+**'s and **X**'s. These are some of several simple shapes we are practicing for letter formation. Please have your child trace the dotted **+**'s and **X**'s on the front and back of this activity page, starting each line at a star.

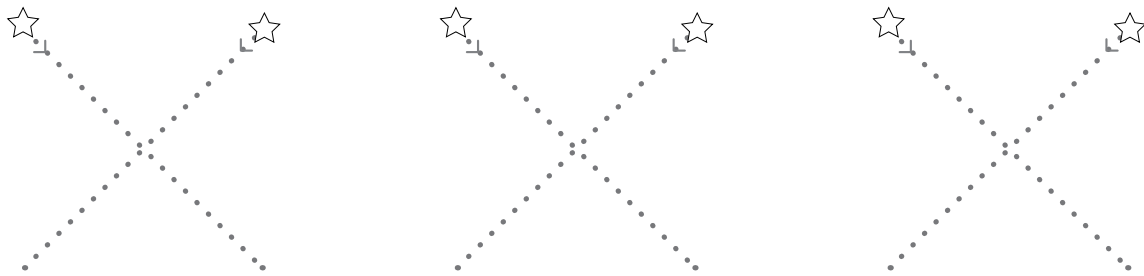
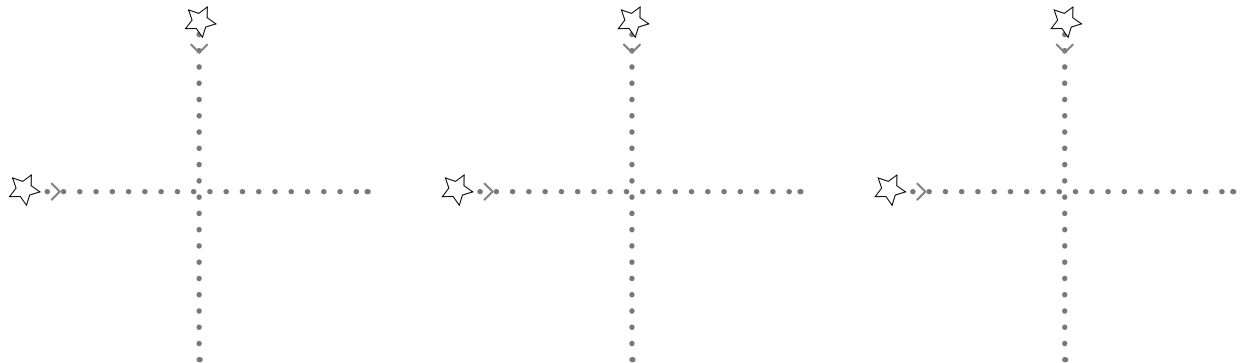
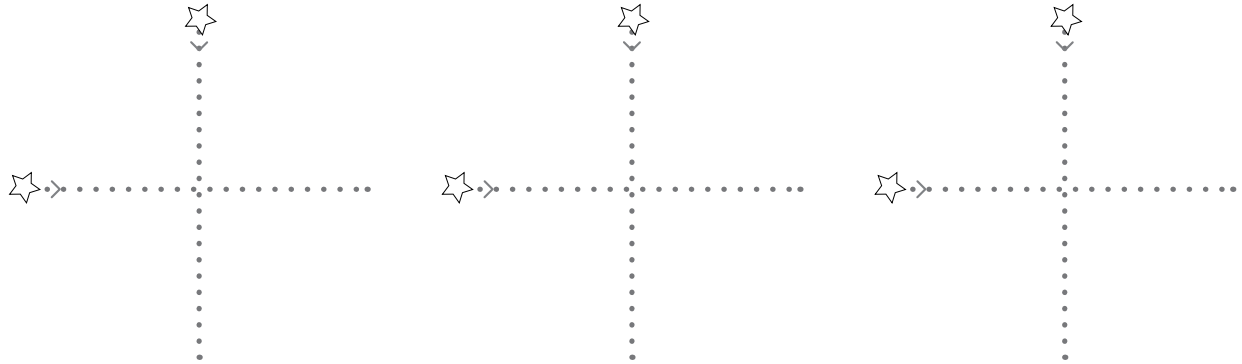

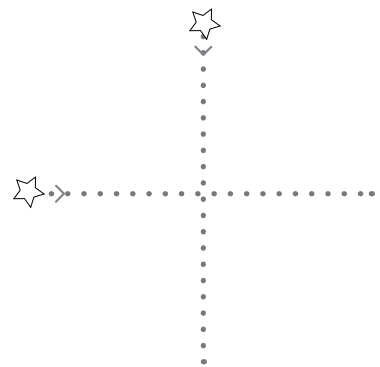
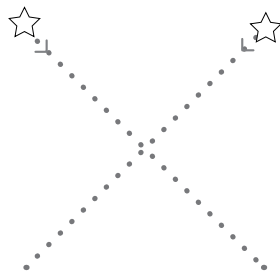
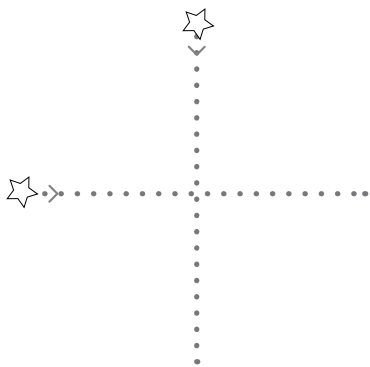
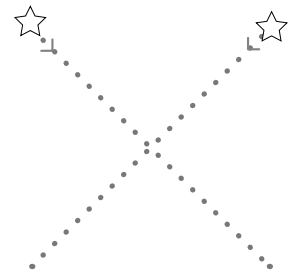
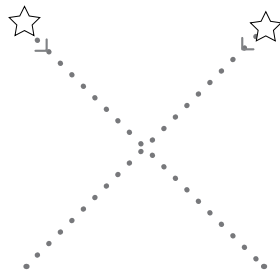
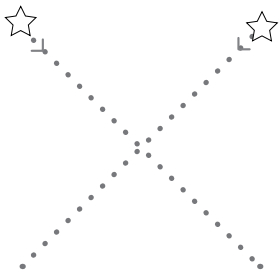
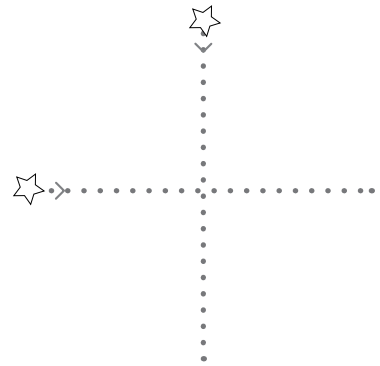
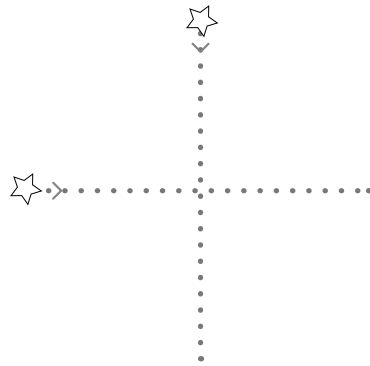
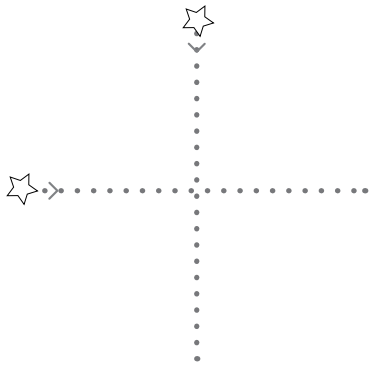
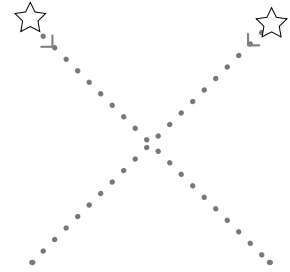
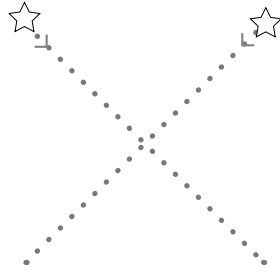
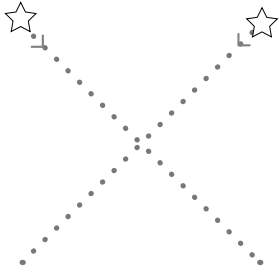

NAME: \_\_\_\_\_

DATE: \_\_\_\_\_

7.1

Directions: Ask students to trace the dotted loops, starting at the stars. Students may color the pictures (optional).

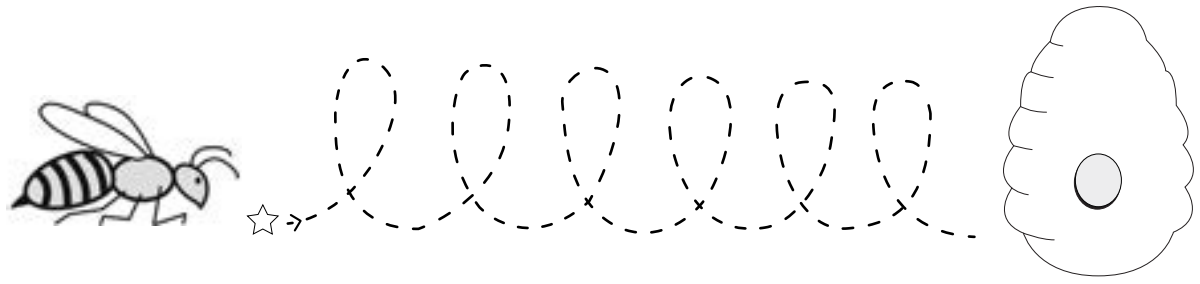
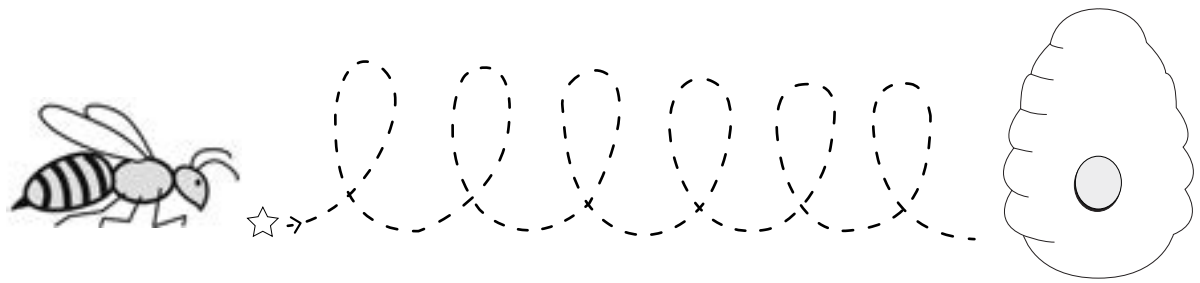
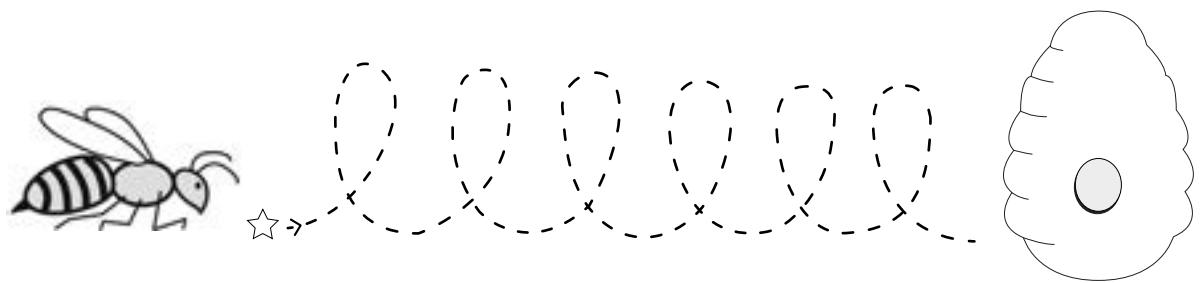
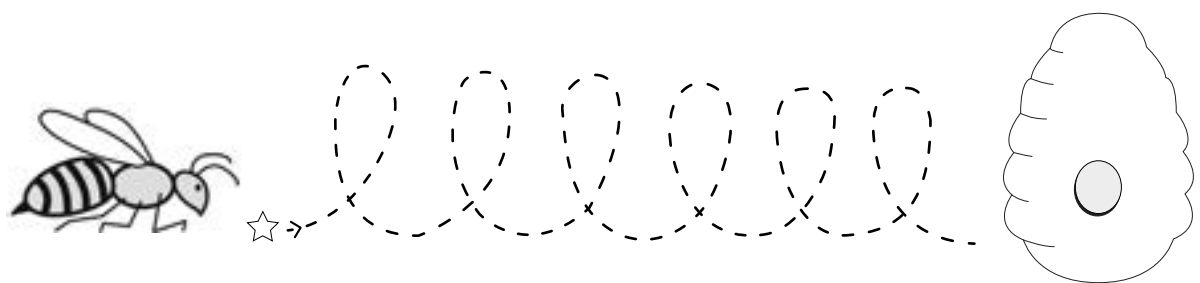
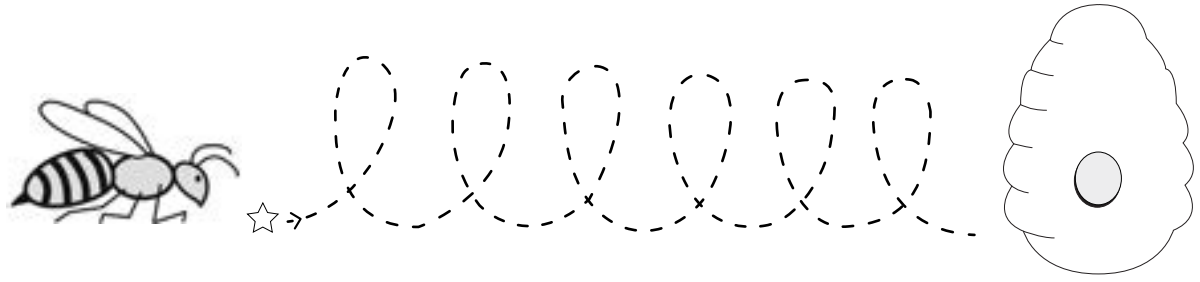

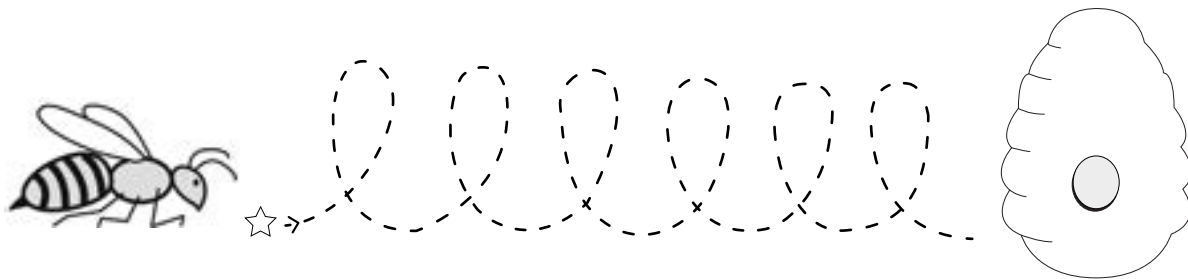
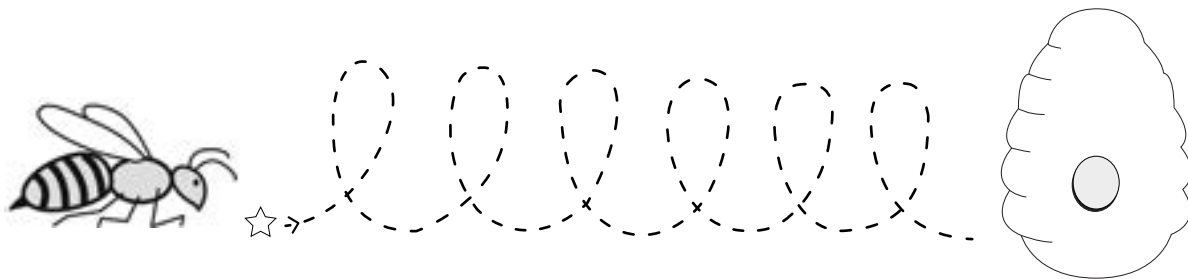
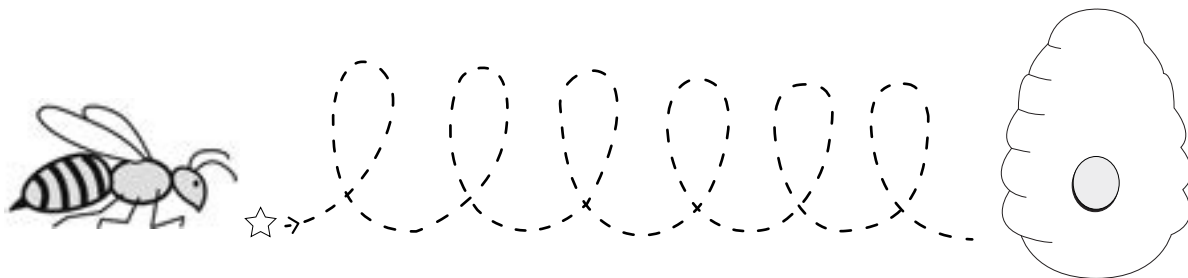
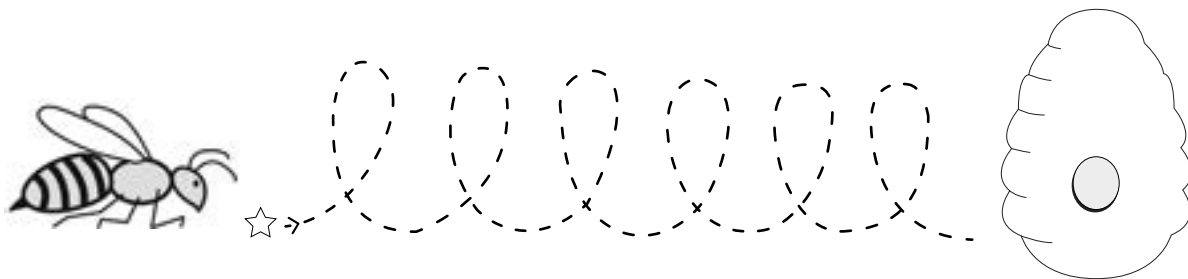
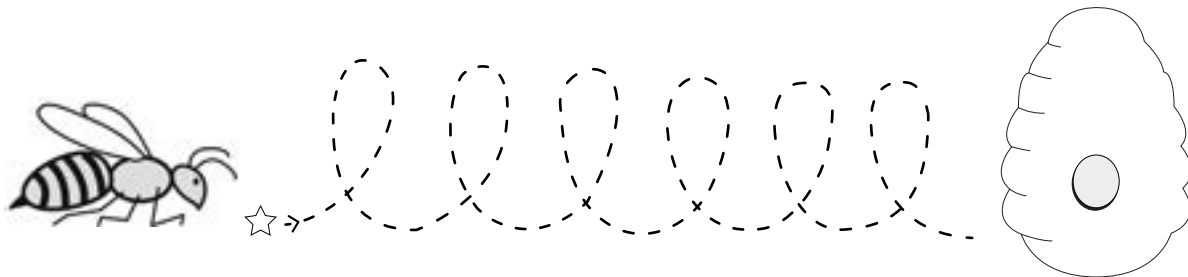



NAME: \_\_\_\_\_











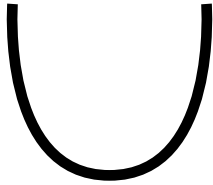
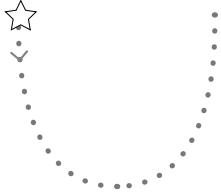

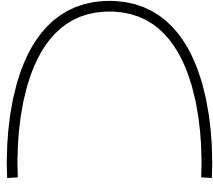
DATE: \_\_\_\_\_











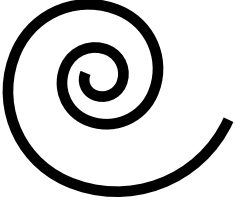
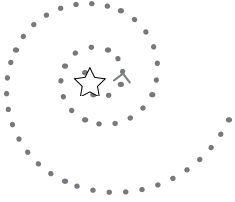

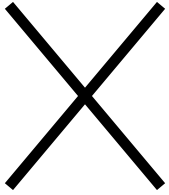
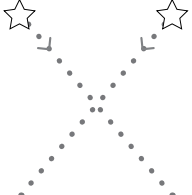
7.2

Take-Home

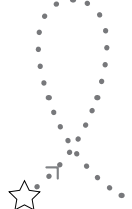
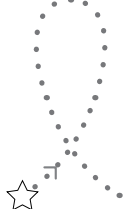
**Dear Family Member,**

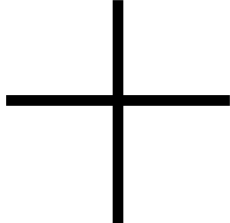
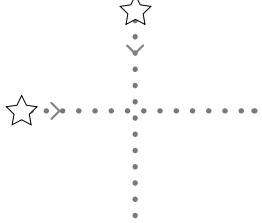
On the front and back of this activity page are a number of simple shapes we are practicing for letter formation. Please have your child trace the dotted shapes, starting at the stars. Then have them draw the shape on their own, starting at the star.

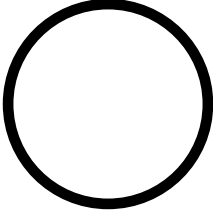
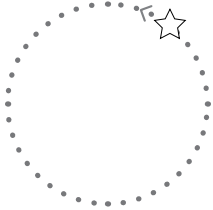
|                                                                                     |                                                                                      |                                                                                     |                                                                                       |
|-------------------------------------------------------------------------------------|--------------------------------------------------------------------------------------|-------------------------------------------------------------------------------------|---------------------------------------------------------------------------------------|
|    |     |    |    |
|   |    |   |   |
|  |   |  |  |
|  |  |                                                                                     |                                                                                       |

|                                                                                     |                                                                                     |                                                                                      |                                                                                       |
|-------------------------------------------------------------------------------------|-------------------------------------------------------------------------------------|--------------------------------------------------------------------------------------|---------------------------------------------------------------------------------------|
|    |    |     |    |
|    |    |    |    |
|   |   |   |   |
|  |  |  |  |
|  |  |  |  |

NAME: \_\_\_\_\_

DATE: \_\_\_\_\_

8.1

Activity Page

Directions: Ask students to trace the dotted canes, starting at the stars. Students may color the pictures (optional).

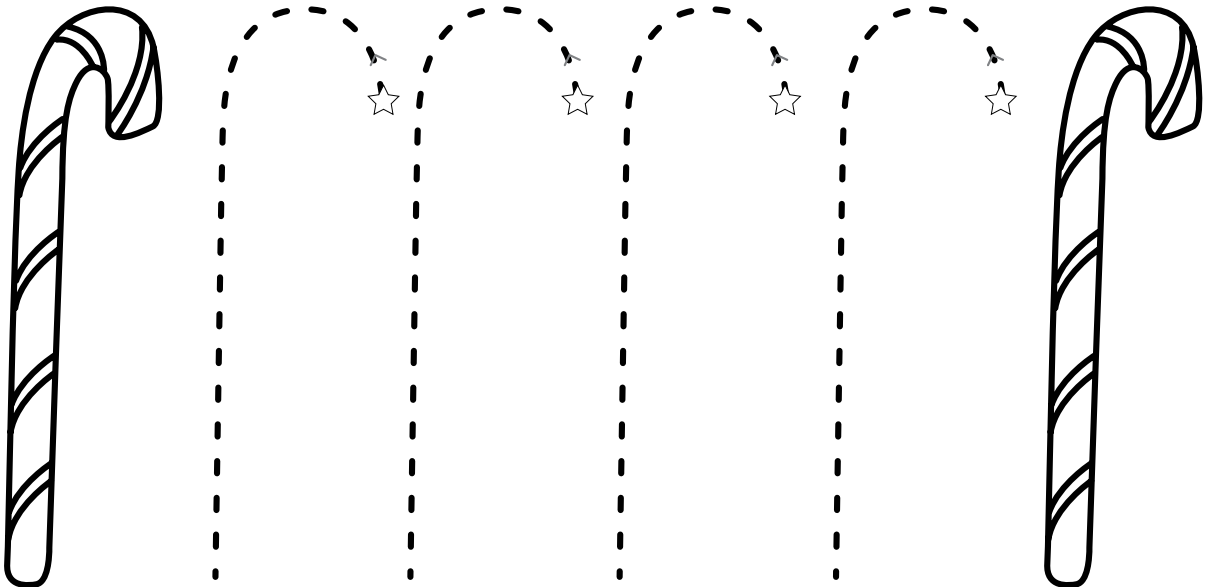
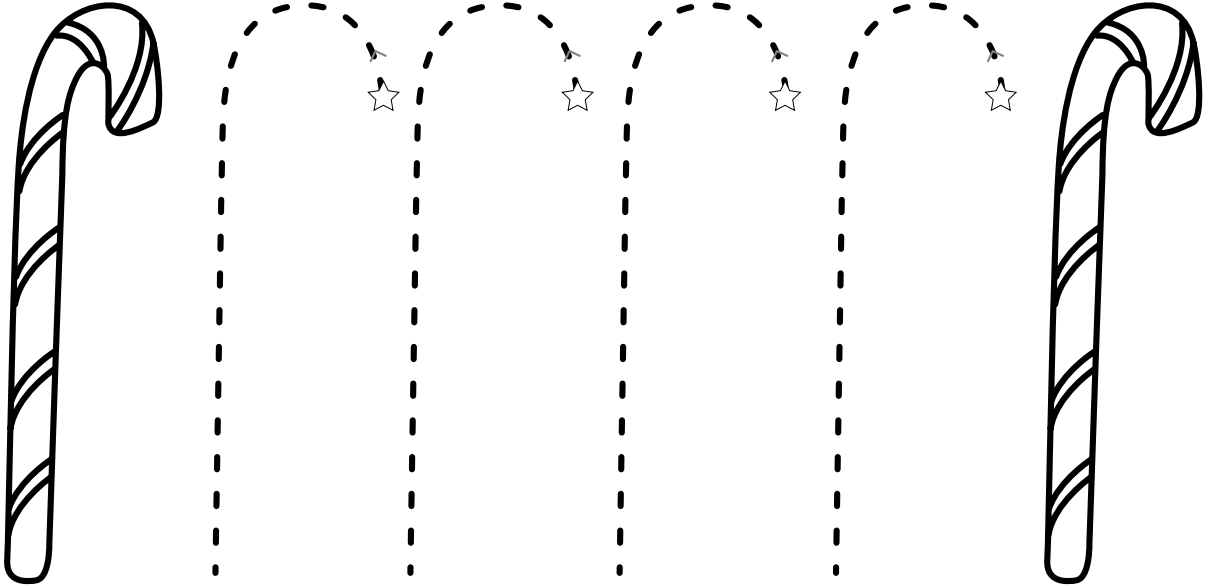

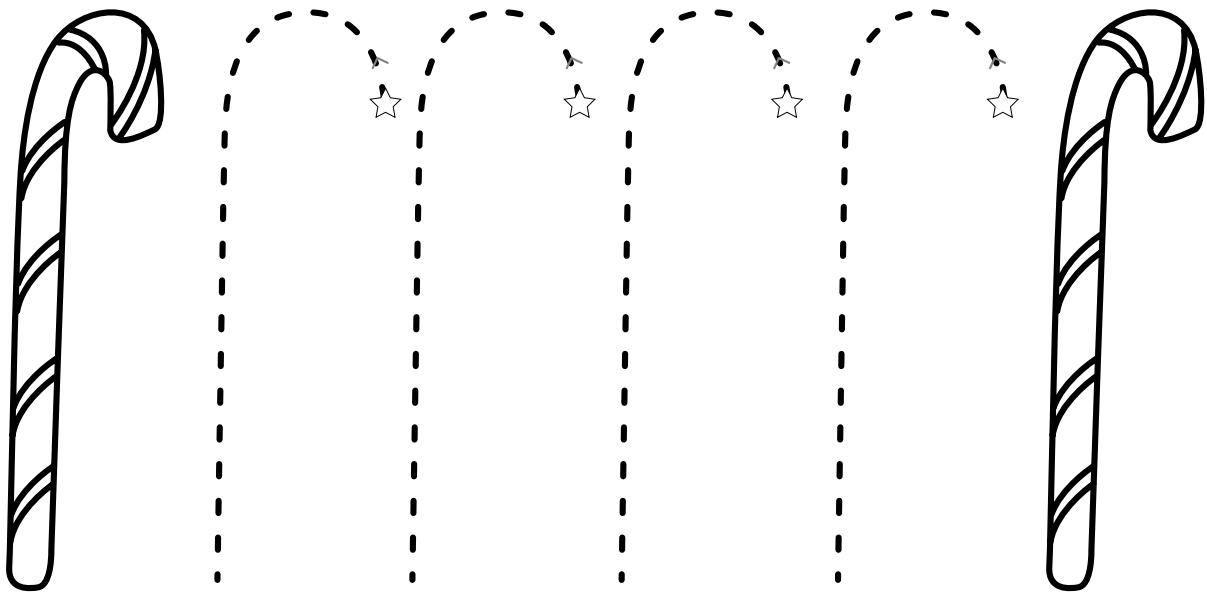
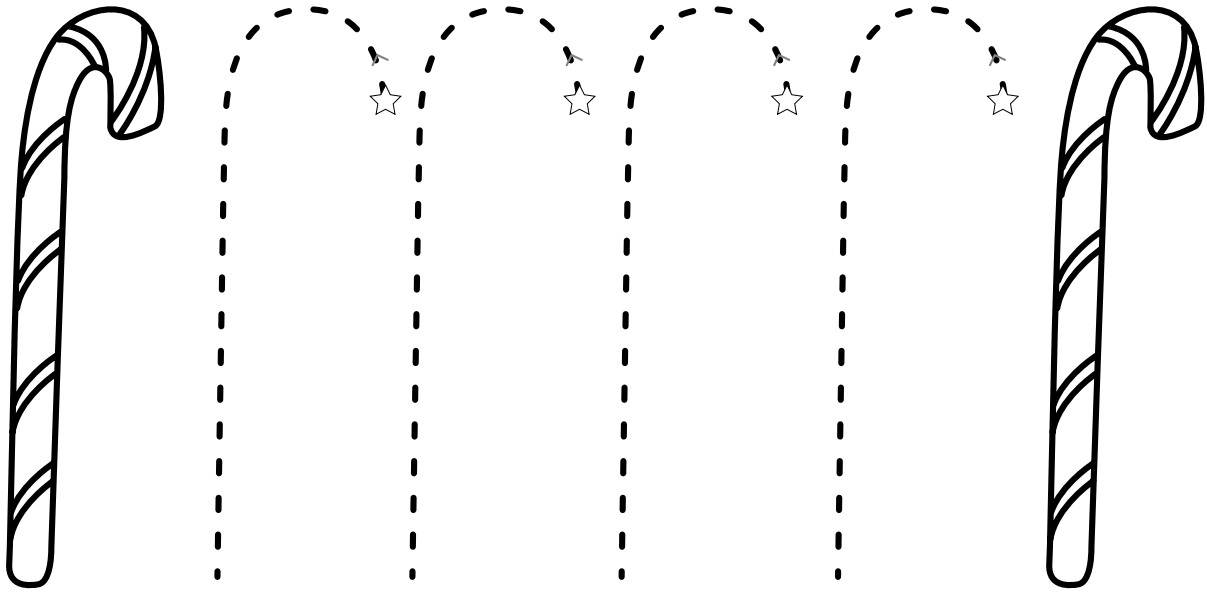

NAME: \_\_\_\_\_

DATE: \_\_\_\_\_

8.2

Take-Home

**Dear Family Member,**

In class, we have been practicing the cane shape. This is one of several simple shapes we are practicing for letter formation. Please have your child trace the dotted canes on the front and back of this activity page, starting at the stars.

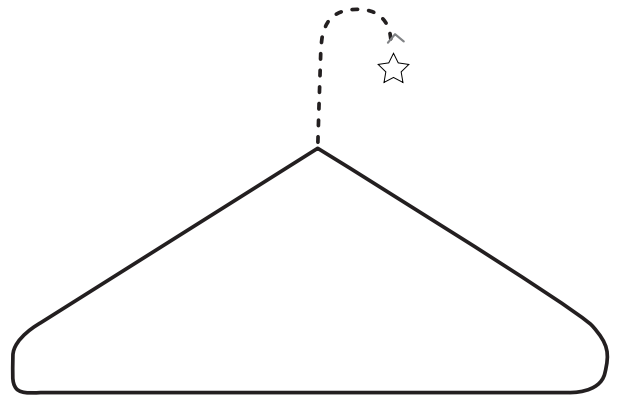
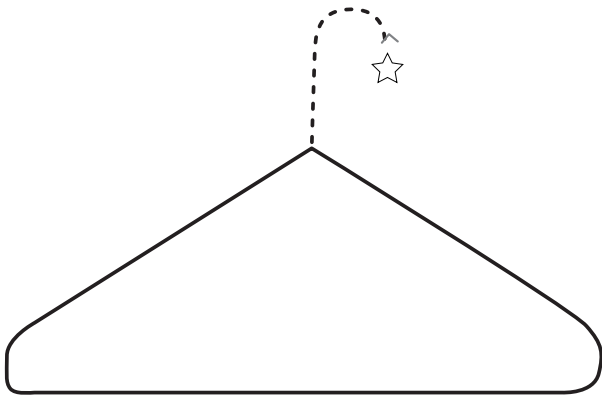
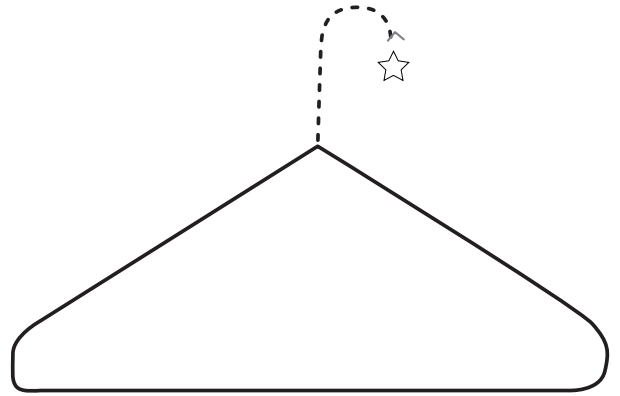
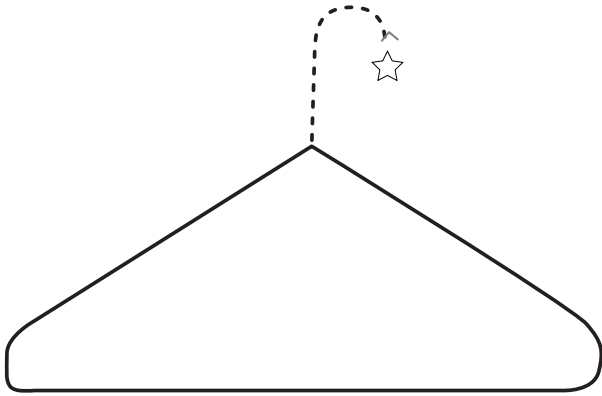
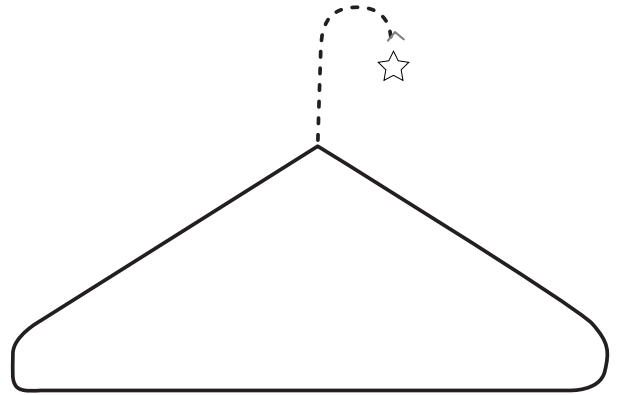
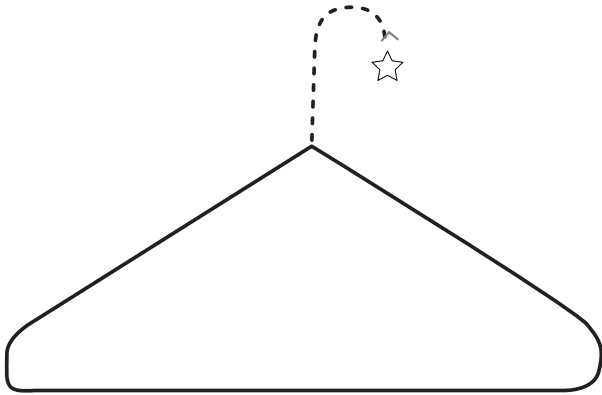

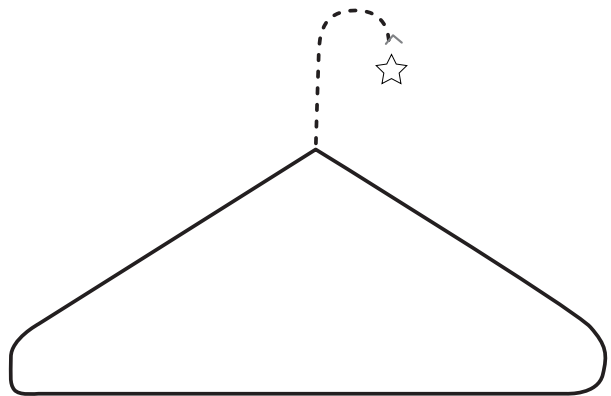
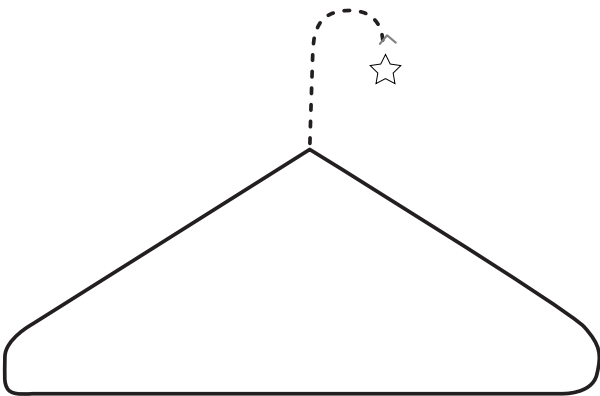
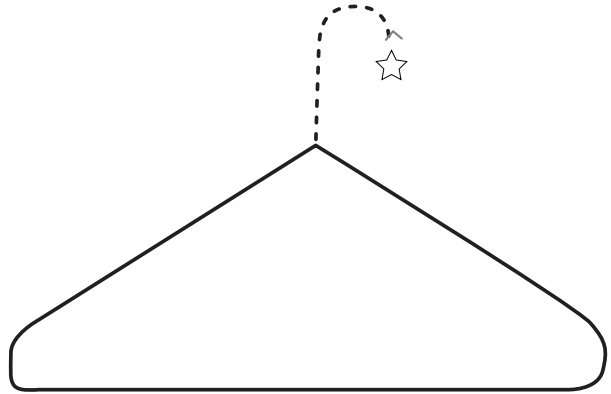
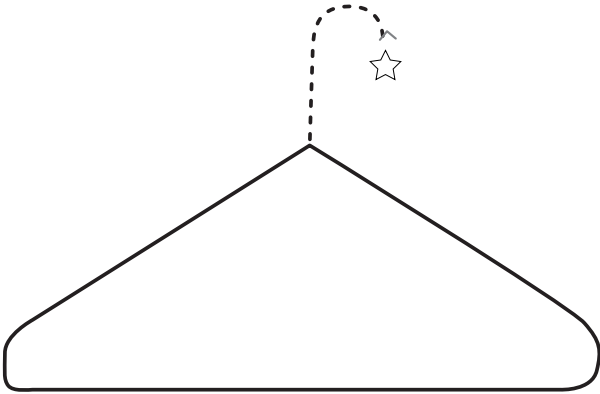
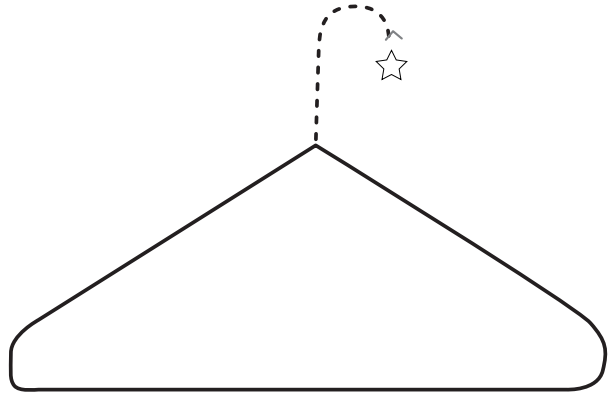
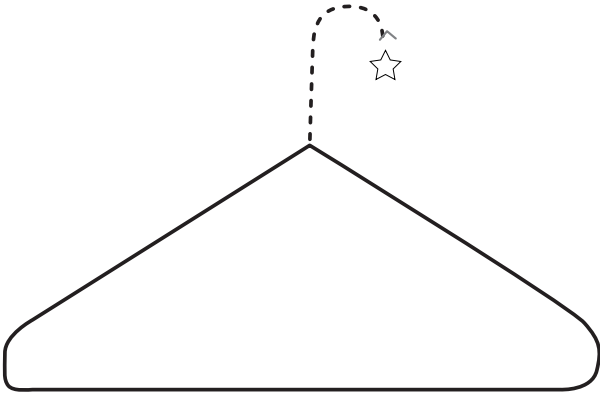

NAME: \_\_\_\_\_

DATE: \_\_\_\_\_

9.1

Activity Page

Directions: Ask students to trace the dotted hooks, starting at the stars. Students may color the pictures (optional).

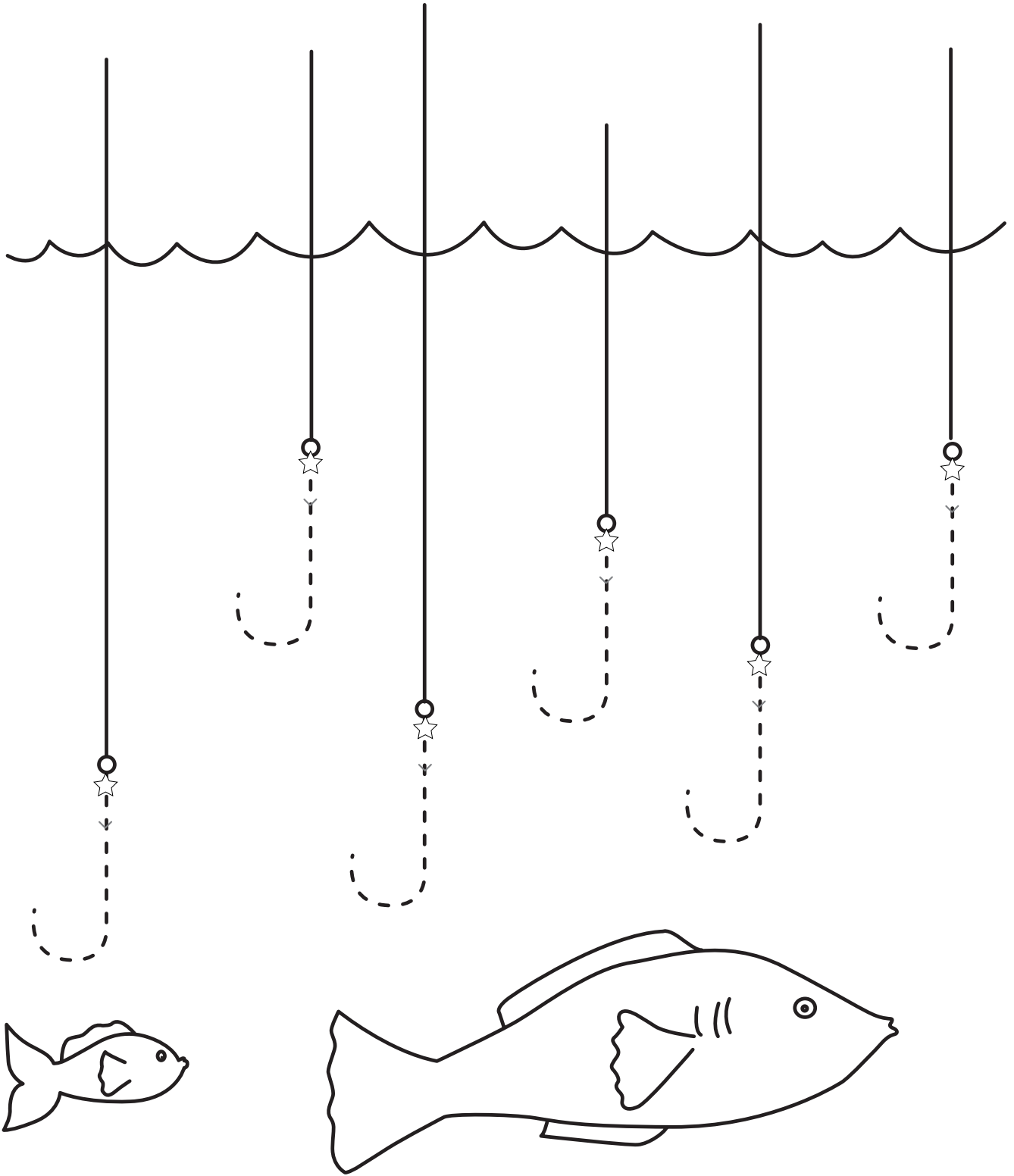

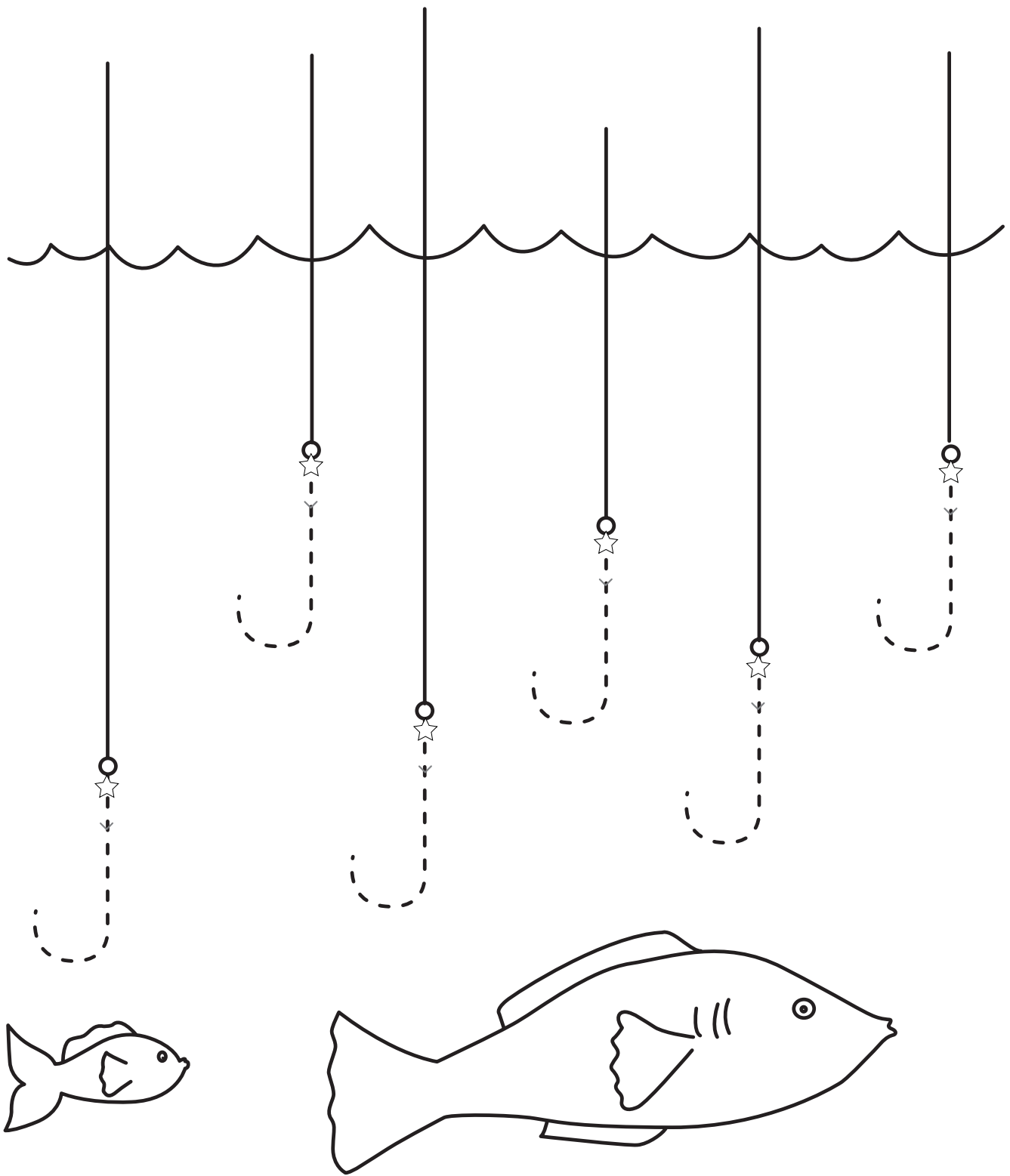



NAME: \_\_\_\_\_

DATE: \_\_\_\_\_

9.2

Take-Home

**Dear Family Member,**

In class, we have been practicing the hook shape. This is one of several simple shapes we are practicing for letter formation. Please have your child trace the dotted hooks on the front and back of this activity page, starting at the stars.

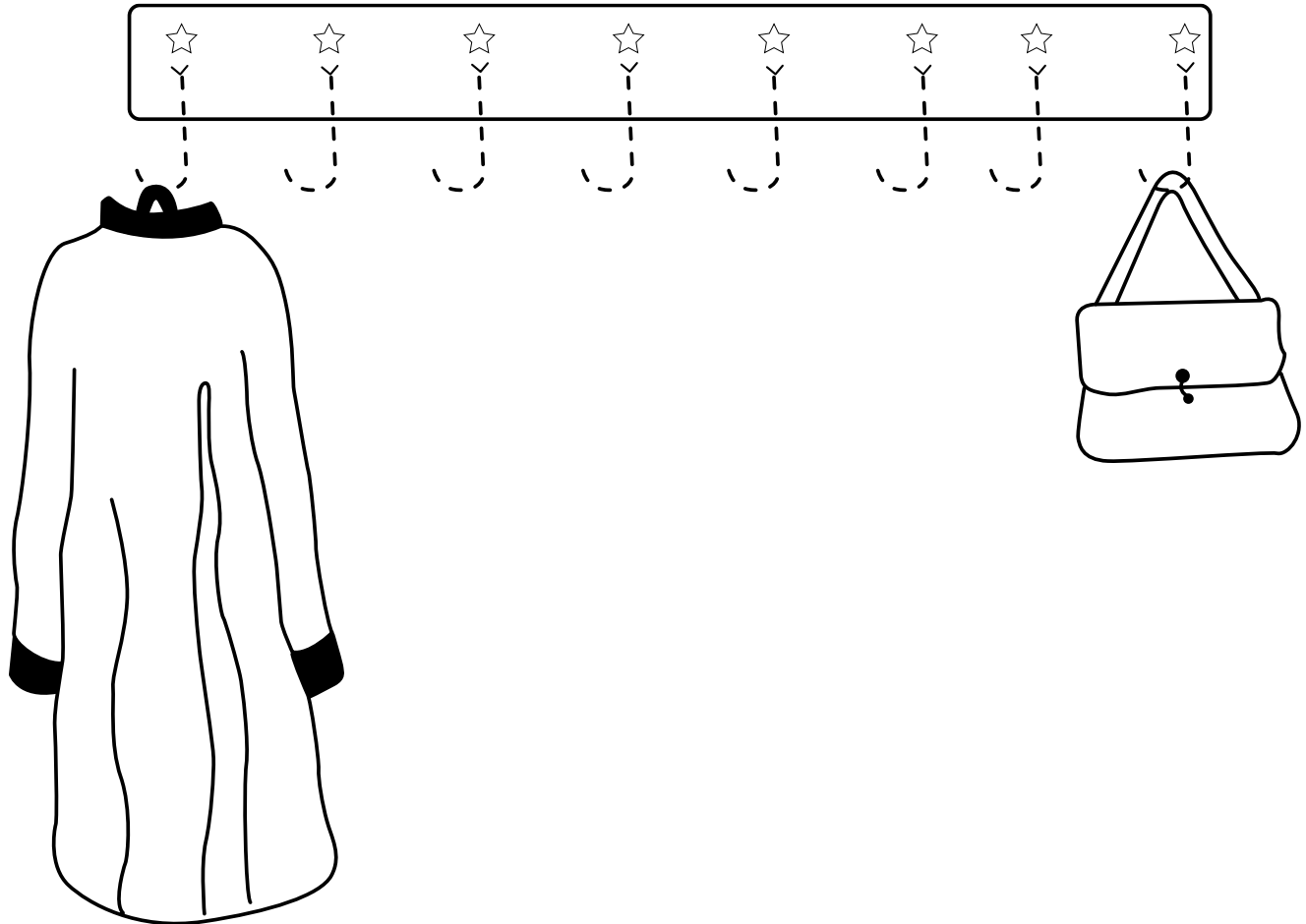

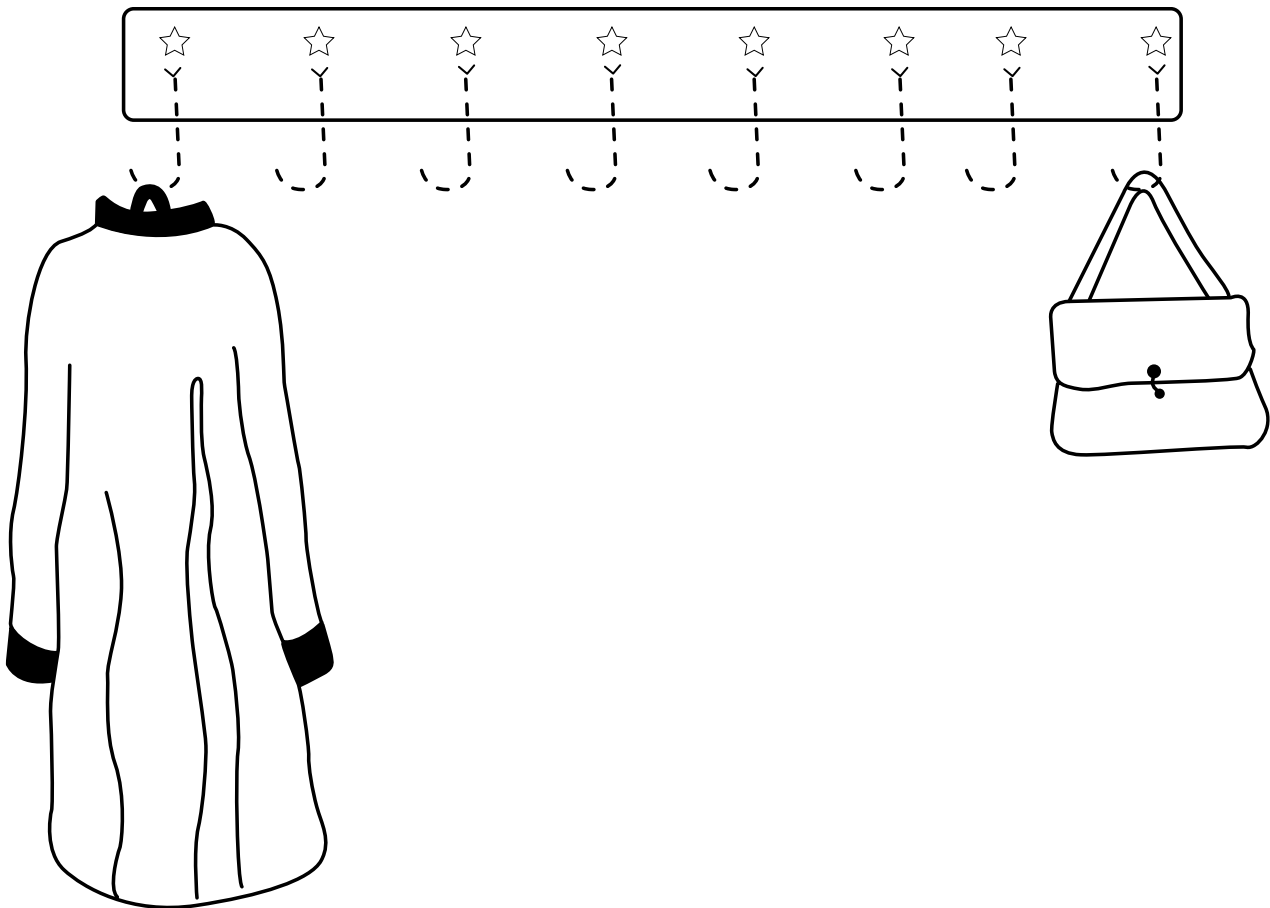
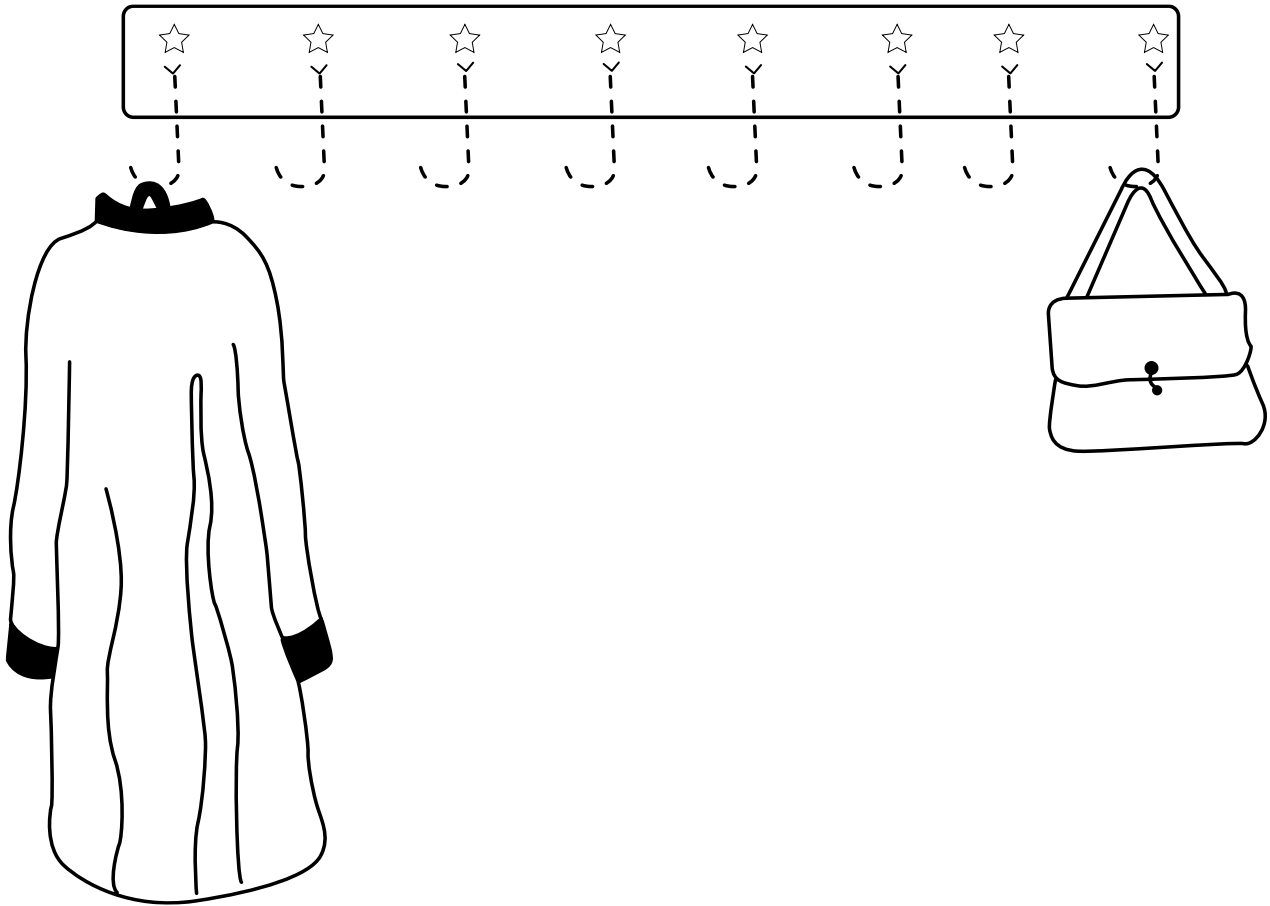



NAME: \_\_\_\_\_

DATE: \_\_\_\_\_

10.1  
PART 1

Assessment

Directions: Ask students to copy each shape.

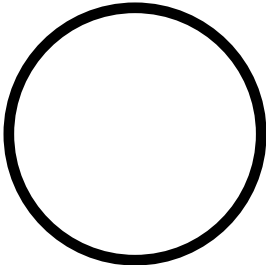
|                                                                                     |  |
|-------------------------------------------------------------------------------------|--|
|    |  |
|   |  |
|  |  |
|  |  |

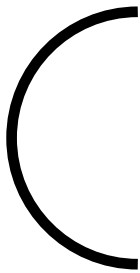
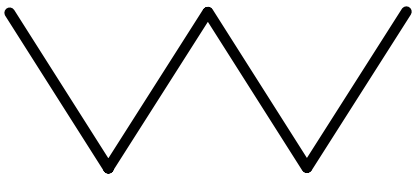
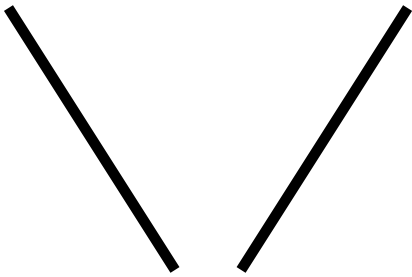
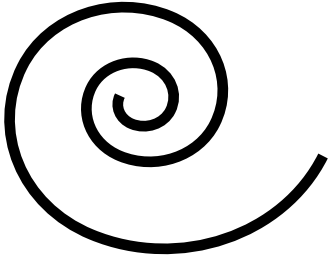

NAME: \_\_\_\_\_

DATE: \_\_\_\_\_

10.2  
PART 1

Assessment

Directions: Ask students to copy each shape.

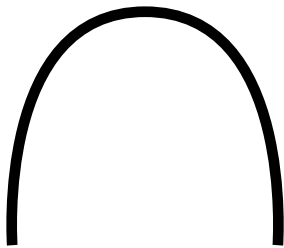
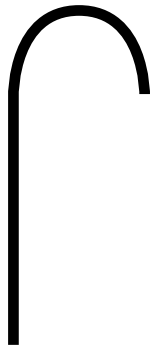
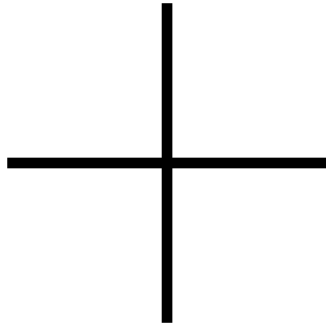

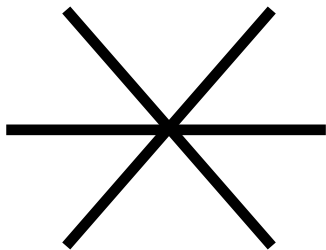
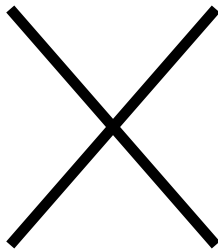
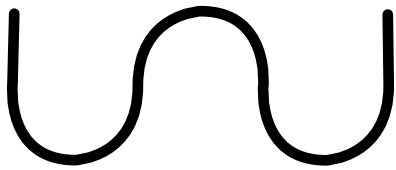
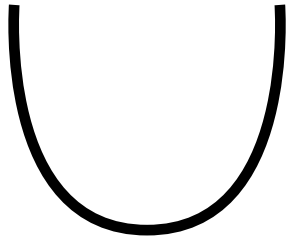

NAME: \_\_\_\_\_

DATE: \_\_\_\_\_

# 10.3

PART 2

Assessment

Directions: Orally segment each word and have students circle each picture.

1.



2.

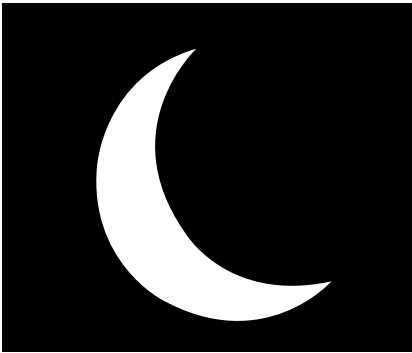

3.



4.



Part 2, Blending Score: \_\_\_\_\_

5.



6.



7.



8.



9.



10.





NAME: \_\_\_\_\_

DATE: \_\_\_\_\_

10.4

Take-Home

**Dear Family Member,**

In class, we have been using the terms “beginning” and “end.” Knowing these terms is important for tracking from the beginning of a row to the end of a row when reading. For each row, please have your child color the shape at the *beginning* green and the shape at the *end* red, saying the word *beginning* or *end* as they color each of them.

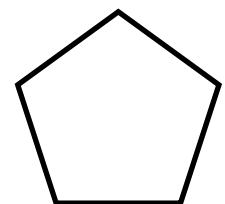
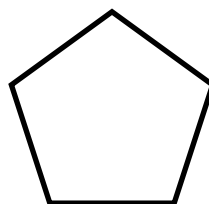
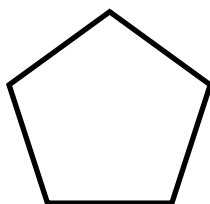
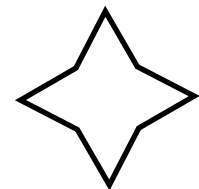
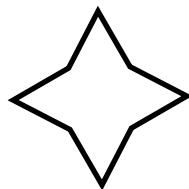
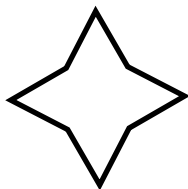
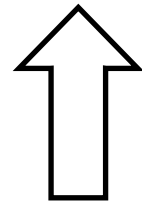
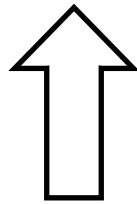
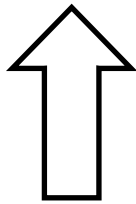
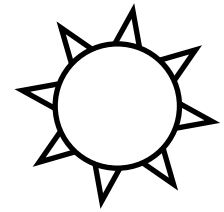
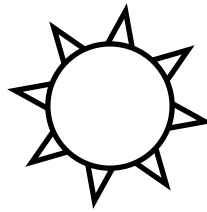
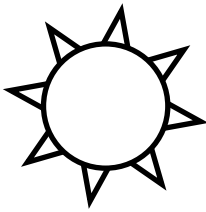

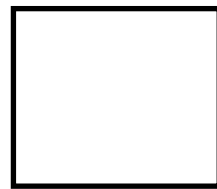
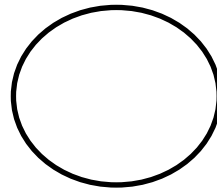
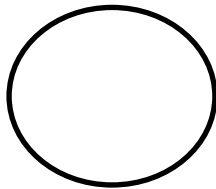
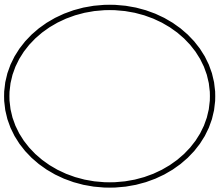
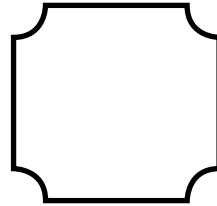
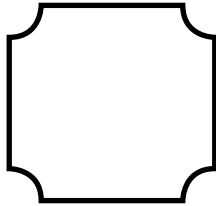
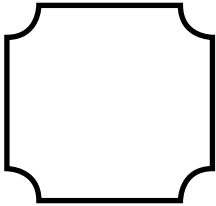
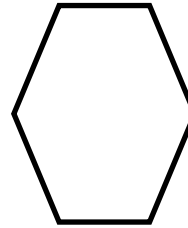
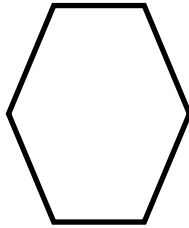
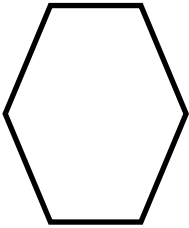
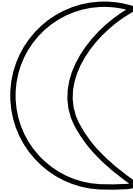
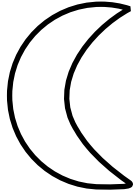
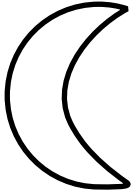











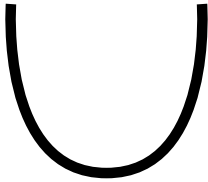



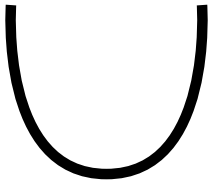



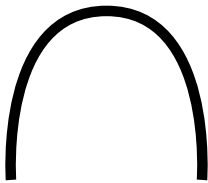



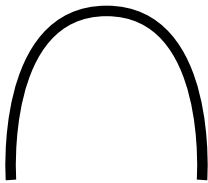

NAME: \_\_\_\_\_











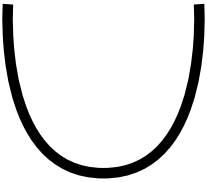



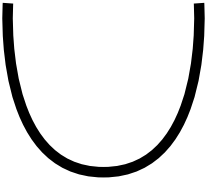



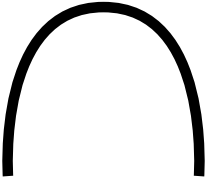



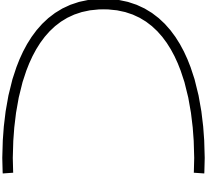

DATE: \_\_\_\_\_

PP.1

Activity Page

Directions: Ask students to first trace and then draw each shape.

|                                                                                     |                                                                                     |                                                                                      |                                                                                       |
|-------------------------------------------------------------------------------------|-------------------------------------------------------------------------------------|--------------------------------------------------------------------------------------|---------------------------------------------------------------------------------------|
|    |    |    |    |
|    |    |     |    |
|   |   |   |   |
|  |  |   |  |
|  |  |  |  |
|  |  |   |  |

|                                                                                     |                                                                                     |                                                                                      |                                                                                       |
|-------------------------------------------------------------------------------------|-------------------------------------------------------------------------------------|--------------------------------------------------------------------------------------|---------------------------------------------------------------------------------------|
|    |    |    |    |
|    |    |     |    |
|   |   |   |   |
|  |  |   |  |
|  |  |  |  |
|  |  |   |  |











NAME: \_\_\_\_\_



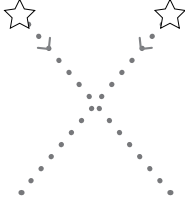
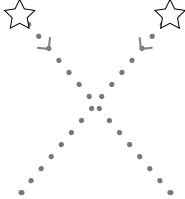
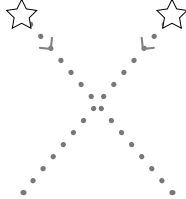
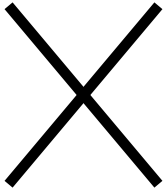
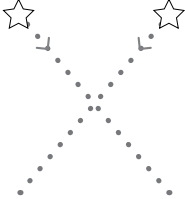

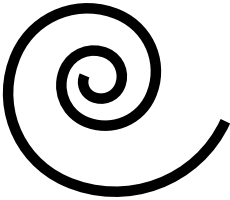
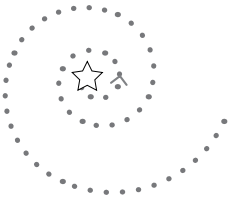
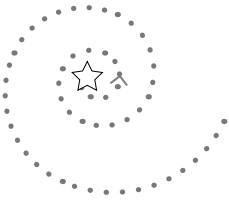
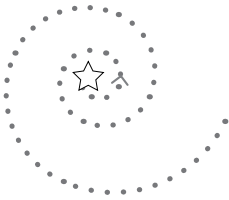
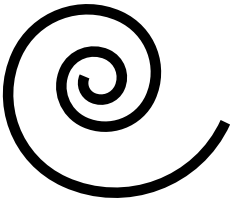
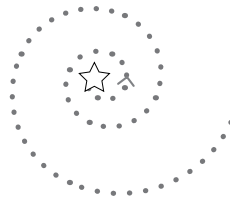

DATE: \_\_\_\_\_

PP.2

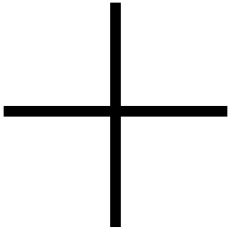
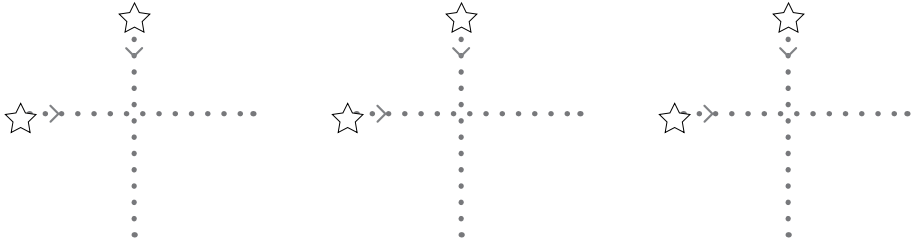
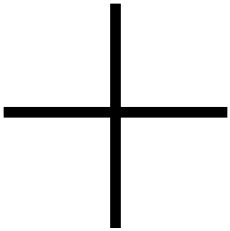
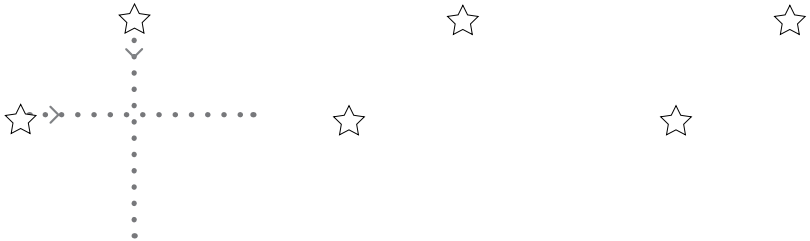
Activity Page

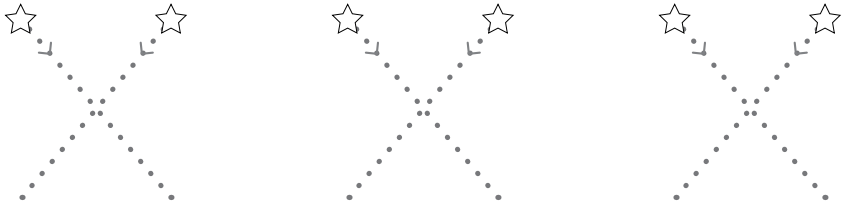
Directions: Ask students to first trace and then draw each shape

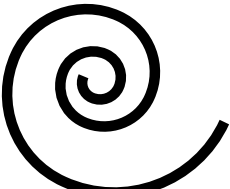
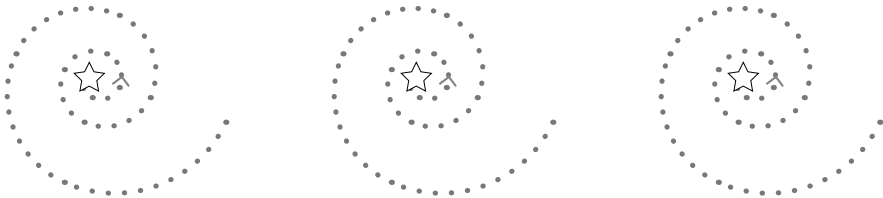
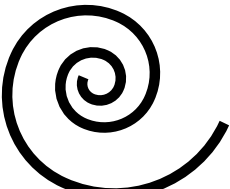
|                                                                                     |                                                                                                                                                                                                                                                                                                                                                                                                                                           |
|-------------------------------------------------------------------------------------|-------------------------------------------------------------------------------------------------------------------------------------------------------------------------------------------------------------------------------------------------------------------------------------------------------------------------------------------------------------------------------------------------------------------------------------------|
|    |                                                                                                                                                                                                                                                                                                                                                         |
|    |                                                                                                                                                                                                                                                                                                                                                          |
|   |                                                                                                                                                                                  |
|  |      |
|  |                                                                                                                                                                               |
|  |                                                                                                                                                                              |

|                                                                                     |                                                                                      |
|-------------------------------------------------------------------------------------|--------------------------------------------------------------------------------------|
|    |    |
|    |    |
|   |   |
|  |  |
|  |  |
|  |  |











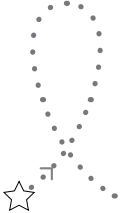

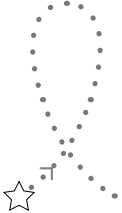

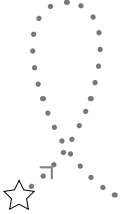







NAME: \_\_\_\_\_











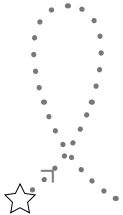
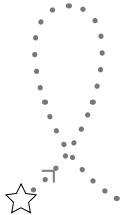
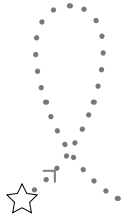

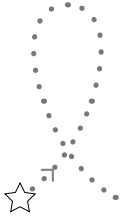







DATE: \_\_\_\_\_

PP.3

Activity Page

Directions: Ask students to first trace and then draw each shape.

|                                                                                     |                                                                                     |                                                                                       |                                                                                       |
|-------------------------------------------------------------------------------------|-------------------------------------------------------------------------------------|---------------------------------------------------------------------------------------|---------------------------------------------------------------------------------------|
|    |    |     |    |
|    |    |     |    |
|   |   |    |   |
|  |  |  |  |
|  |  |   |  |
|  |  |  |  |

|                                                                                     |                                                                                     |                                                                                      |                                                                                       |
|-------------------------------------------------------------------------------------|-------------------------------------------------------------------------------------|--------------------------------------------------------------------------------------|---------------------------------------------------------------------------------------|
|    |    |    |    |
|    |    |     |    |
|   |   |   |   |
|  |  |   |  |
|  |  |  |  |
|  |  |   |  |



























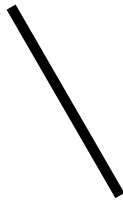









NAME: \_\_\_\_\_

DATE: \_\_\_\_\_

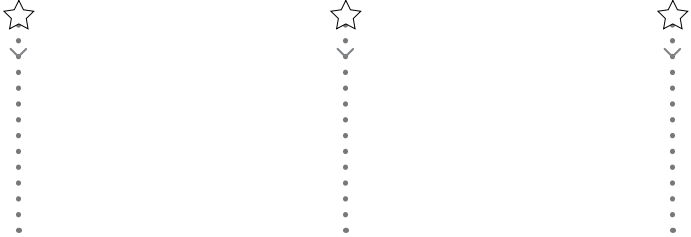
# PP.4

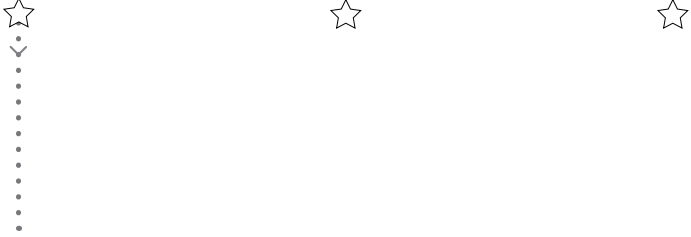
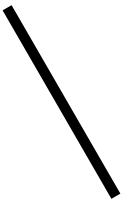
Directions: Ask students to first trace and then draw each shape.

|                                                                                     |                                                                                     |                                                                                       |                                                                                       |
|-------------------------------------------------------------------------------------|-------------------------------------------------------------------------------------|---------------------------------------------------------------------------------------|---------------------------------------------------------------------------------------|
|    |    |     |    |
|    |    |      |    |
|   |   |   |   |
|  |  |  |  |
|  |  |   |  |
|  |  |   |  |

|                                                                                     |                                                                                      |
|-------------------------------------------------------------------------------------|--------------------------------------------------------------------------------------|
|    |    |
|    |    |
|   |   |
|  |  |
|  |  |
|  |  |









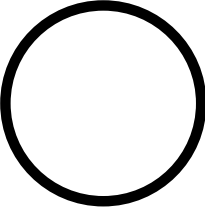
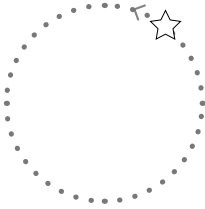
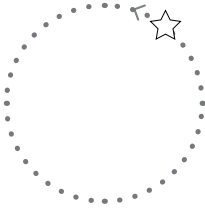
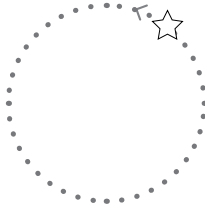
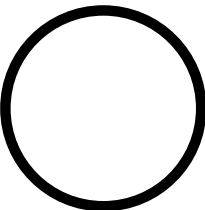
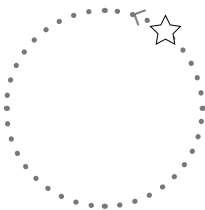

NAME: \_\_\_\_\_

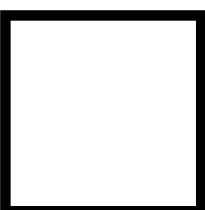

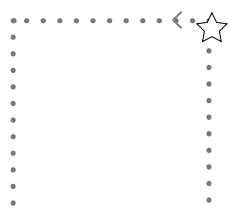
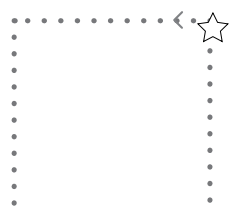
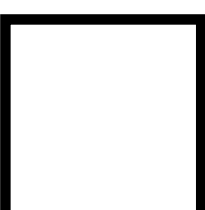



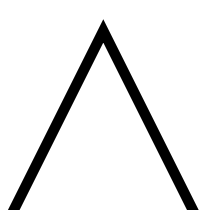
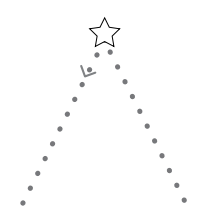
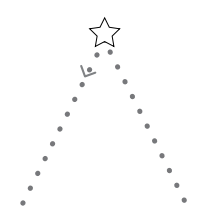
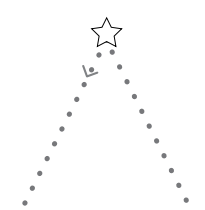
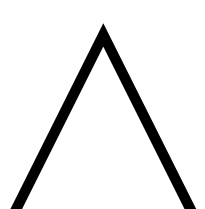
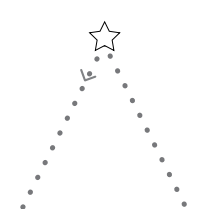

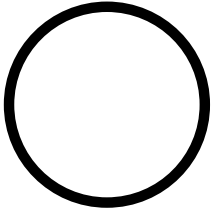

DATE: \_\_\_\_\_

PP.5

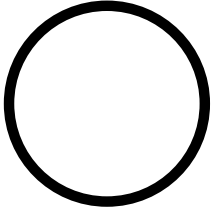
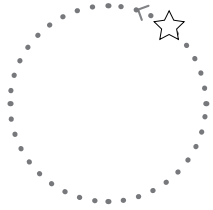
Activity Page

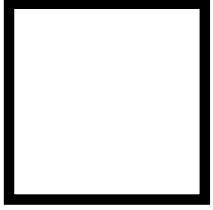
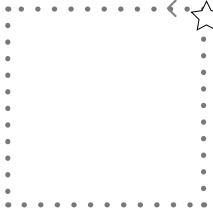
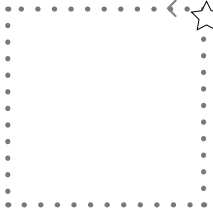
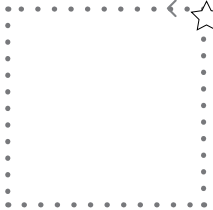
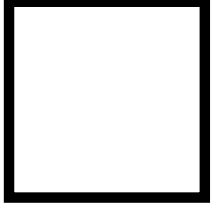
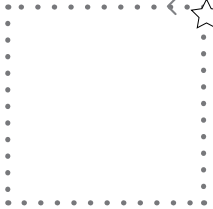
Directions: Ask students to first trace and then draw each shape.

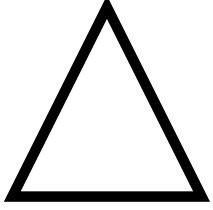
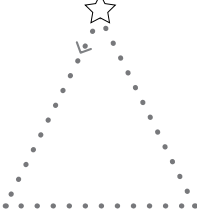
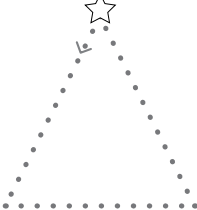
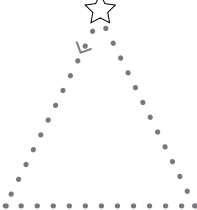
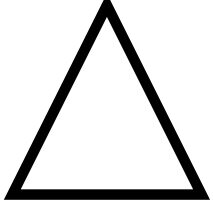
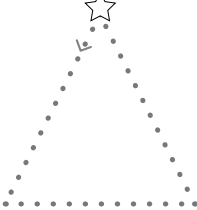
|                                                                                     |                                                                                     |                                                                                       |                                                                                       |
|-------------------------------------------------------------------------------------|-------------------------------------------------------------------------------------|---------------------------------------------------------------------------------------|---------------------------------------------------------------------------------------|
|    |    |     |    |
|    |    |    |    |
|   |   |    |   |
|  |  |  |  |
|  |  |   |  |
|  |  |  |  |

|                                                                                     |                                                                                     |                                                                                       |                                                                                       |
|-------------------------------------------------------------------------------------|-------------------------------------------------------------------------------------|---------------------------------------------------------------------------------------|---------------------------------------------------------------------------------------|
|    |    |     |    |
|    |    |    |    |
|   |   |    |   |
|  |  |  |  |
|  |  |   |  |
|  |  |    |  |

NAME: \_\_\_\_\_

DATE: \_\_\_\_\_

PP.6

Activity Page

*Directions: Using different colors, have students decorate the interior of the shape using a combination of writing strokes.*

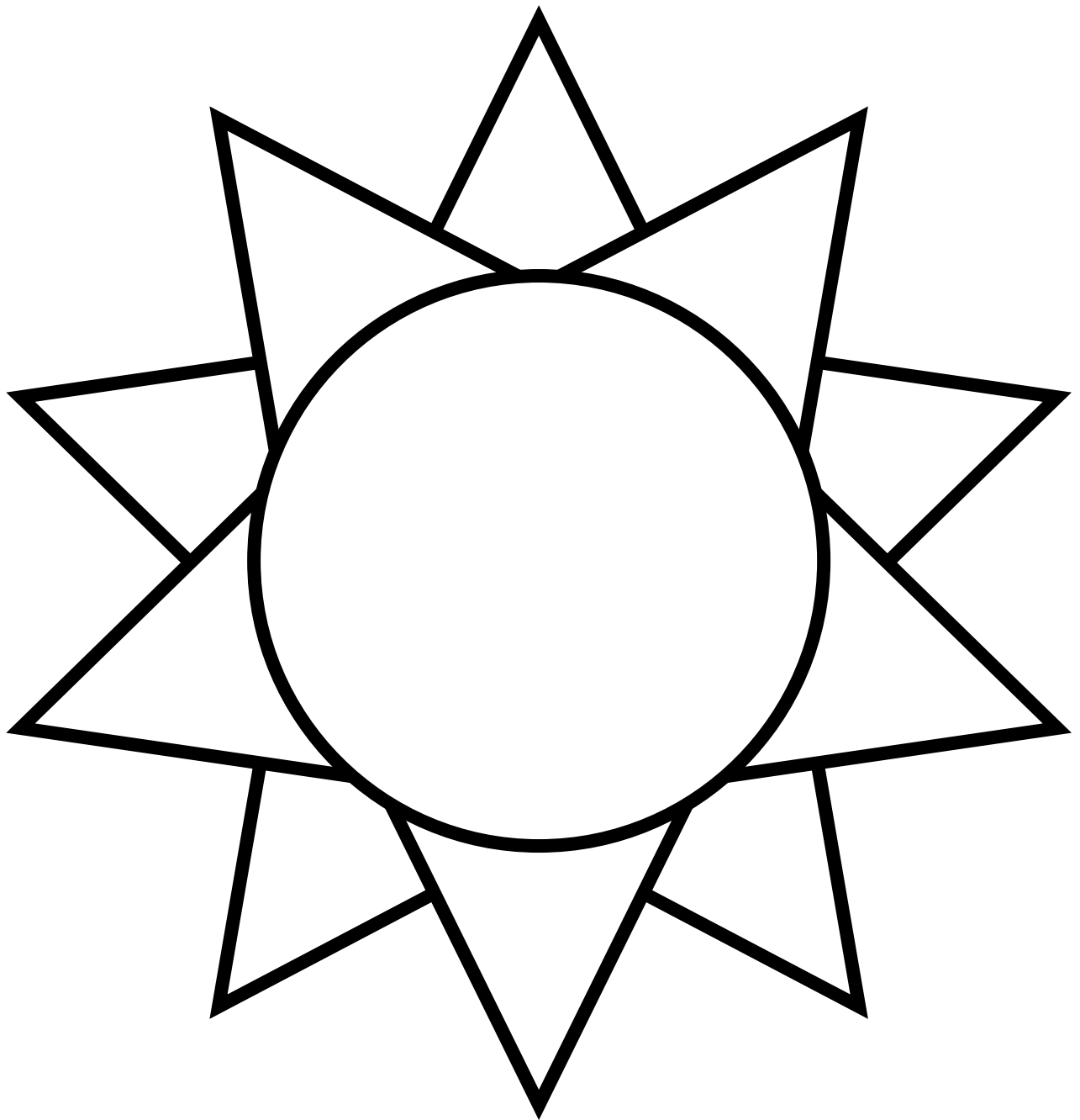



NAME: \_\_\_\_\_

DATE: \_\_\_\_\_

PP.7

Activity Page

*Directions: Using different colors, have students decorate the interior of the shape using a combination of writing strokes.*

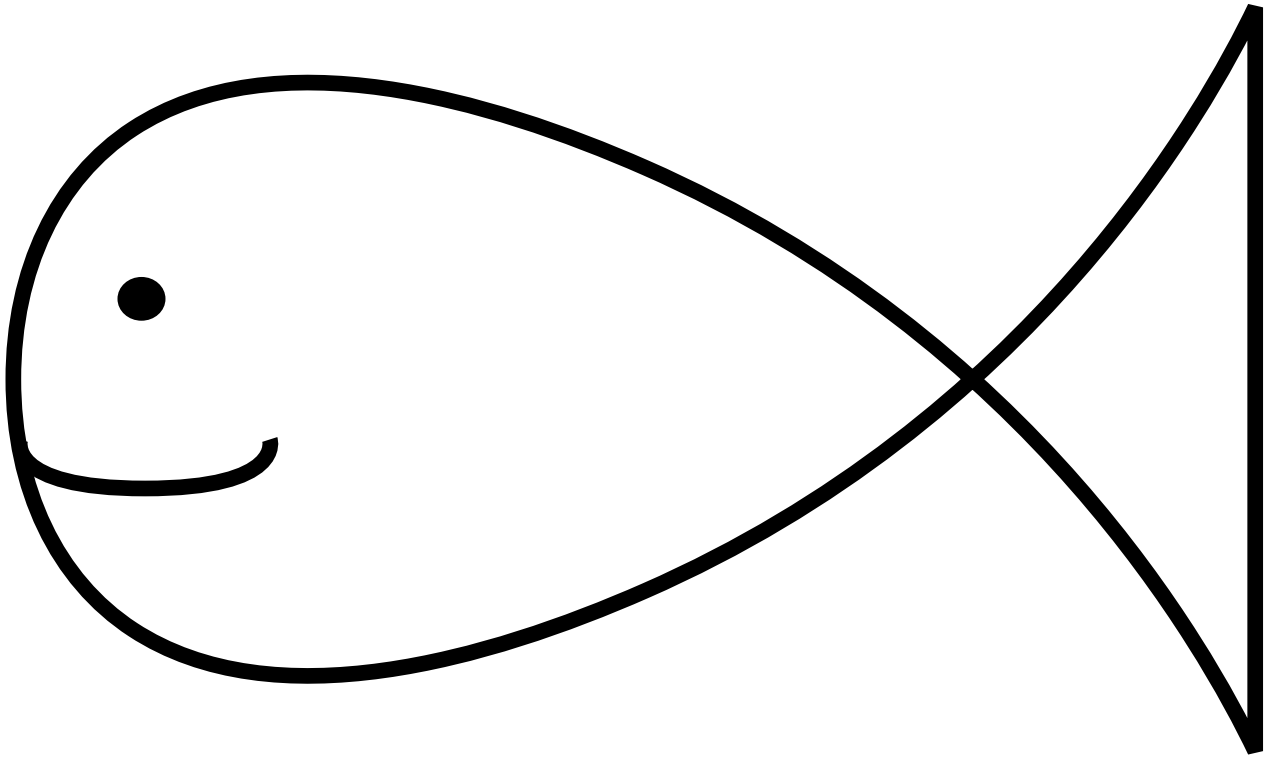





NAME: \_\_\_\_\_

DATE: \_\_\_\_\_

Directions: Using different colors, have students decorate the interior of the shape using a combination of writing strokes.

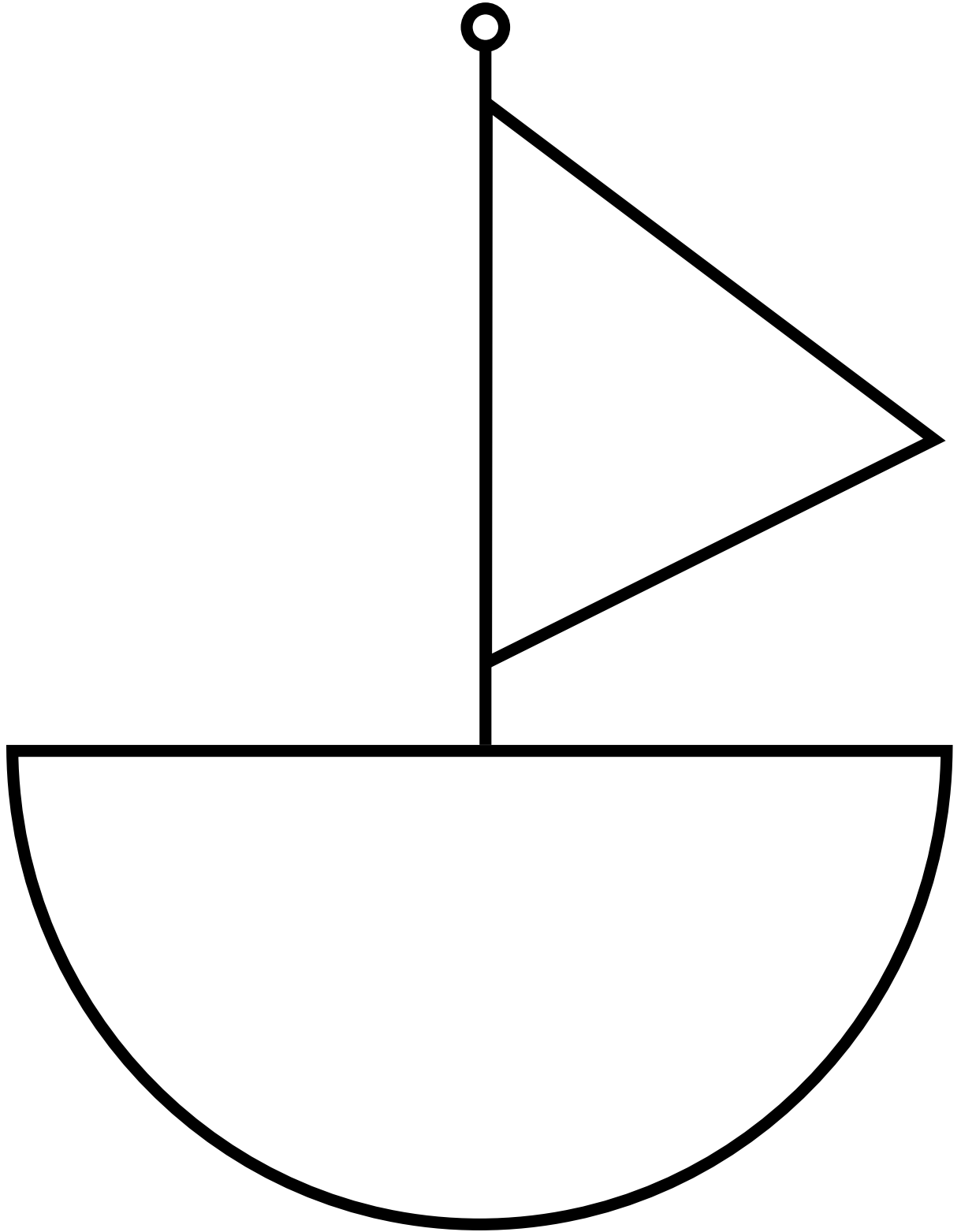



NAME: \_\_\_\_\_

DATE: \_\_\_\_\_

PP.9

*Directions: Using different colors, have students decorate the interior of the shape using a combination of writing strokes.*

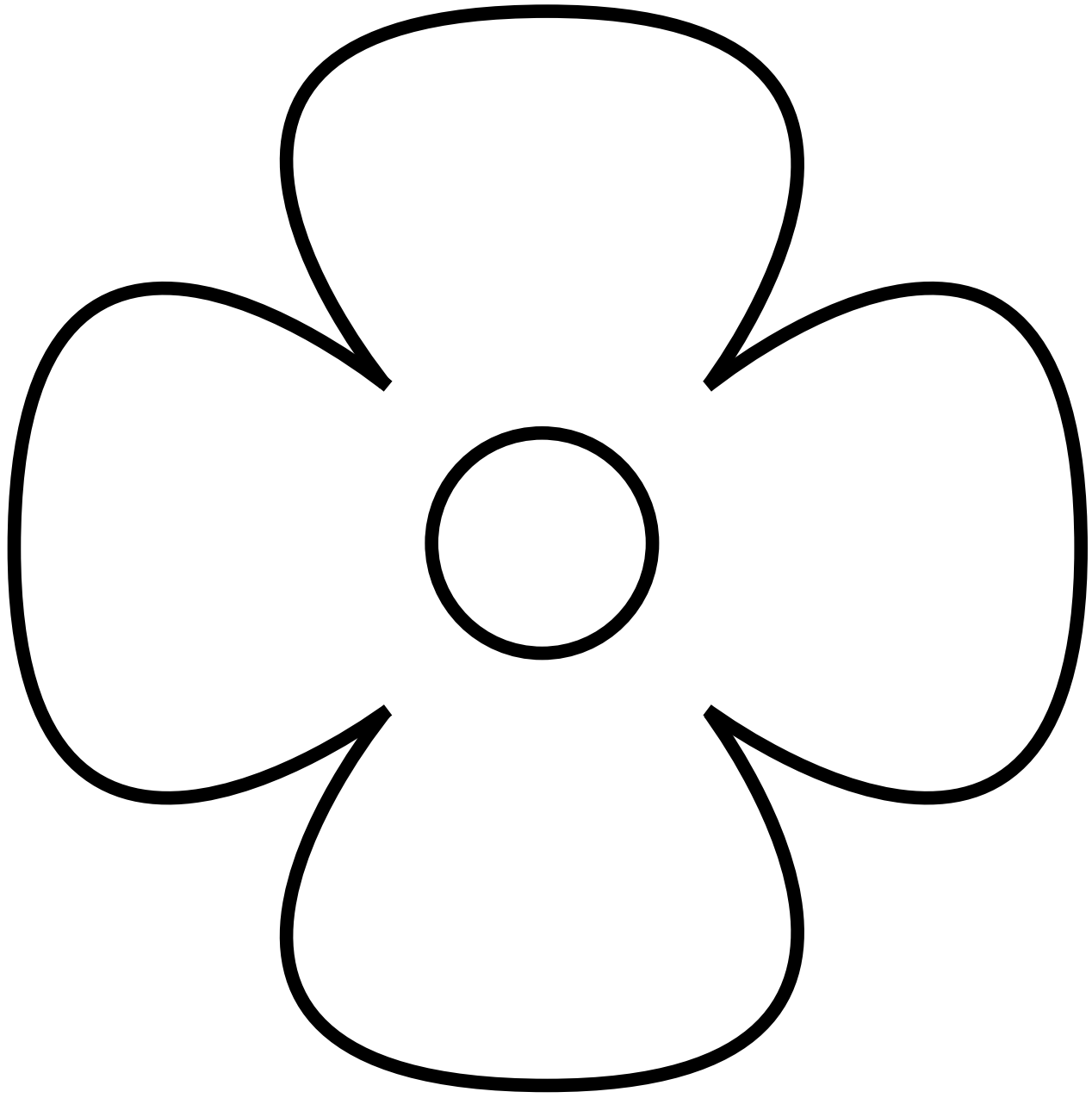





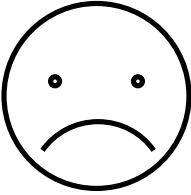
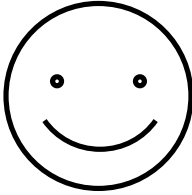
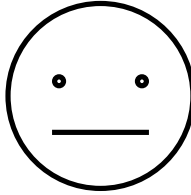
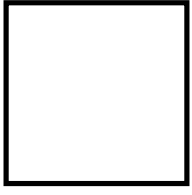
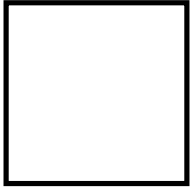
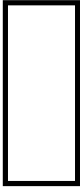

NAME: \_\_\_\_\_

DATE: \_\_\_\_\_

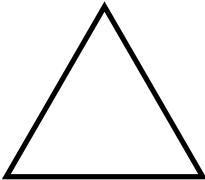
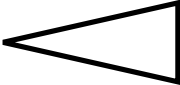
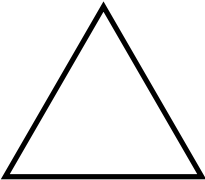
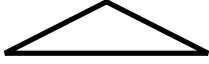
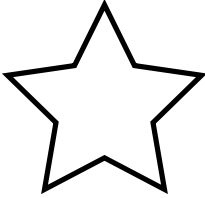
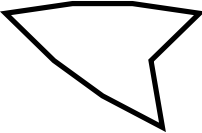
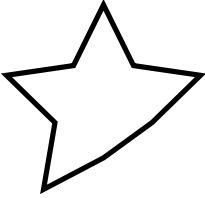
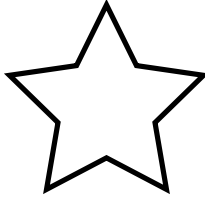
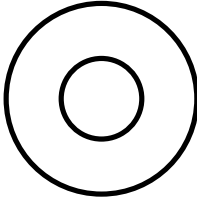
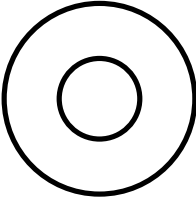
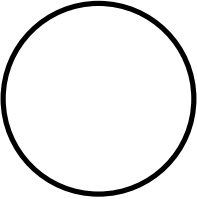
Directions: For each row, have students circle the shape that is the same as the shape on the left and cross out the shapes that are different.

|                                                                                     |                                                                                     |                                                                                      |                                                                                       |
|-------------------------------------------------------------------------------------|-------------------------------------------------------------------------------------|--------------------------------------------------------------------------------------|---------------------------------------------------------------------------------------|
|    |    |    |    |
|    |    |   |    |
|  |  |  |  |
|  |  |  |  |
|  |  |  |  |



NAME: \_\_\_\_\_

DATE: \_\_\_\_\_

PP.11

Directions: For each row, have students circle the shape that is the same as the shape on the left and cross out the shape that is different.

|   |   |   |
|---|---|---|
| t | f | t |
| i | j | i |
| w | w | v |
| o | a | o |
| d | d | b |
| e | e | c |

|   |   |   |
|---|---|---|
| n | n | m |
| x | t | x |
| u | n | u |
| g | g | a |
| h | n | h |
| f | t | f |



NAME: \_\_\_\_\_

DATE: \_\_\_\_\_

Directions: For each row, have students color the shape that is at the beginning green, the shape that is at the middle yellow, and the shape that is at the end red.

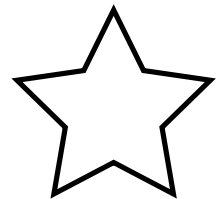
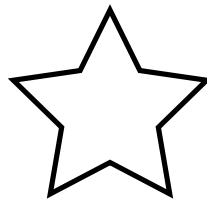
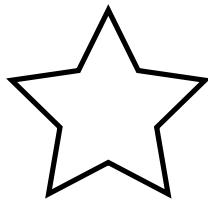
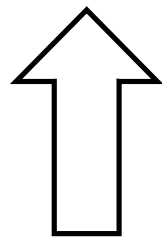
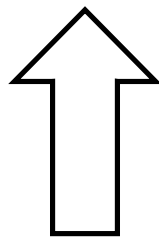
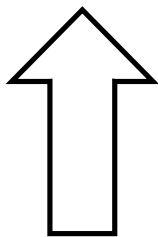
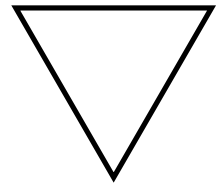
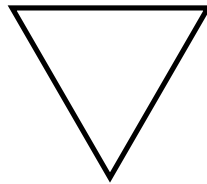
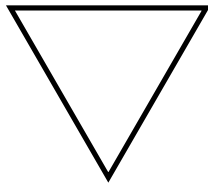
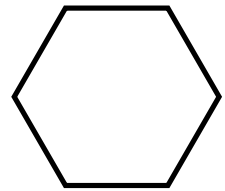
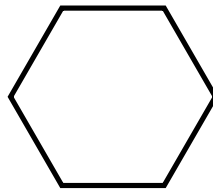
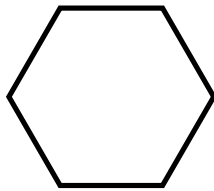
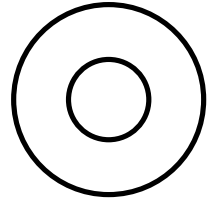
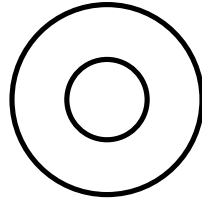
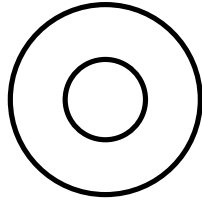



## General Manager K-8 Humanities and SVP, Product

Alexandra Clarke

## Chief Academic Officer, Elementary Humanities

Susan Lambert

### Content and Editorial

Elizabeth Wade, PhD, Director,  
Elementary Language Arts Content

Patricia Erno, Associate Director, Elementary ELA Instruction

Maria Martinez, Associate Director, Spanish Language Arts

Baria Jennings, EdD, Senior Content Developer

Christina Cox, Managing Editor

### Product and Project Management

Ayala Falk, Director, Business and Product Strategy,  
K-8 Language Arts

Amber McWilliams, Senior Product Manager

Elisabeth Hartman, Associate Product Manager

Catherine Alexander, Senior Project Manager, Spanish Language Arts

LaShon Ormond, SVP, Strategic Initiatives

Leslie Johnson, Associate Director, K-8 Language Arts

Thea Aguiar, Director of Strategic Projects, K-5 Language Arts

Zara Chaudhury, Project Manager, K-8 Language Arts

### Design and Production

Tory Novikova, Product Design Director

Erin O'Donnell, Product Design Manager

### Other Contributors

Patricia Beam, Bill Cheng, Ken Harney, Molly Hensley, David Herubin, Sara Hunt, Kristen Kirchner, James Mendez-Hodes, Christopher Miller, Diana Projansky, Todd Rawson, Jennifer Skelley, Julia Sverchuk, Elizabeth Thiers, Amanda Tolentino, Paige Womack

## Texas Contributors

### Content and Editorial

Sarah Cloos

Laia Cortes

Jayana Desai

Angela Donnelly

Claire Dorfman

Ana Mercedes Falcón

Rebecca Figueroa

Nick García

Sandra de Gennaro

Patricia Infanzón-  
Rodríguez

Seamus Kirst

Michelle Koral

Sean McBride

Jacqueline Ovalle

Sofía Pereson

Lilia Perez

Sheri Pineault

Megan Reasor

Marisol Rodriguez

Jessica Roodvoets

Lyna Ward

### Product and Project Management

Stephanie Koleda

Tamara Morris

### Art, Design, and Production

Nanyamka Anderson

Raghav Arumugan

Dani Aviles

Olioli Buika

Sherry Choi

Stuart Dalgo

Edel Ferri

Pedro Ferreira

Nicole Galuszka

Parker-Nia Gordon

Isabel Hetrick

Ian Horst

Ashna Kapadia

Jagriti Khirwar

Julie Kim

Lisa McGarry

Emily Mendoza

Marguerite Oerlemans

Lucas De Oliveira

Tara Pajouhesh

Jackie Pierson

Dominique Ramsey

Darby Raymond-  
Overstreet

Max Reinhardsen

Mia Saine

Nicole Stahl

Flore Thevoux

Jeanne Thornton

Amy Xu

Jules Zuckerberg



**Amplify.**  
**TEXAS**

ELEMENTARY LITERACY PROGRAM  
LECTOESCRITURA EN ESPAÑOL

**Series Editor-in-Chief**

E. D. Hirsch Jr.

**President**

Linda Bevilacqua

**Editorial Staff**

Mick Anderson  
Robin Blackshire  
Laura Drummond  
Emma Earnst  
Lucinda Ewing  
Sara Hunt  
Rosie McCormick  
Cynthia Peng  
Liz Pettit  
Tonya Ronayne  
Deborah Samley  
Kate Stephenson  
Elizabeth Wafler  
James Walsh  
Sarah Zelinke

**Design and Graphics Staff**

Kelsie Harman  
Liz Loewenstein  
Bridget Moriarty  
Lauren Pack

**Consulting Project Management Services**

ScribeConcepts.com

**Additional Consulting Services**

Erin Kist  
Carolyn Pinkerton  
Scott Ritchie  
Kelina Summers

**Acknowledgments**

These materials are the result of the work, advice, and encouragement of numerous individuals over many years. Some of those singled out here already know the depth of our gratitude; others may be surprised to find themselves thanked publicly for help they gave quietly and generously for the sake of the enterprise alone. To helpers named and unnamed we are deeply grateful.

**Contributors to Earlier Versions of These Materials**

Susan B. Albaugh, Kazuko Ashizawa, Kim Berrall, Ang Blanchette, Nancy Braier, Maggie Buchanan, Paula Coyner, Kathryn M. Cummings, Michelle De Groot, Michael Donegan, Diana Espinal, Mary E. Forbes, Michael L. Ford, Sue Fulton, Carolyn Gosse, Dorrit Green, Liza Greene, Ted Hirsch, Danielle Knecht, James K. Lee, Matt Leech, Diane Henry Leipzig, Robin Luecke, Martha G. Mack, Liana Mahoney, Isabel McLean, Steve Morrison, Juliane K. Munson, Elizabeth B. Rasmussen, Ellen Sadler, Rachael L. Shaw, Sivan B. Sherman, Diane Auger Smith, Laura Tortorelli, Khara Turnbull, Miriam E. Vidaver, Michelle L. Warner, Catherine S. Whittington, Jeannette A. Williams.

We would like to extend special recognition to Program Directors Matthew Davis and Souzanne Wright, who were instrumental in the early development of this program.

**Schools**

We are truly grateful to the teachers, students, and administrators of the following schools for their willingness to field-test these materials and for their invaluable advice: Capitol View Elementary, Challenge Foundation Academy (IN), Community Academy Public Charter School, Lake Lure Classical Academy, Lepanto Elementary School, New Holland Core Knowledge Academy, Paramount School of Excellence, Pioneer Challenge Foundation Academy, PS 26R (the Carteret School), PS 30X (Wilton School), PS 50X (Clara Barton School), PS 96Q, PS 102X (Joseph O. Loretan), PS 104Q (the Bays Water), PS 214K (Michael Friedsam), PS 223Q (Lyndon B. Johnson School), PS 308K (Clara Cardwell), PS 333Q (Goldie Maple Academy), Sequoyah Elementary School, South Shore Charter Public School, Spartanburg Charter School, Steed Elementary School, Thomas Jefferson Classical Academy, Three Oaks Elementary, West Manor Elementary.

And a special thanks to the Pilot Coordinators, Anita Henderson, Yasmin Lugo-Hernandez, and Susan Smith, whose suggestions and day-to-day support to teachers using these materials in their classrooms were critical.

## **Credits**

Every effort has been taken to trace and acknowledge copyrights. The editors tender their apologies for any accidental infringement where copyright has proved untraceable. They would be pleased to insert the appropriate acknowledgment in any subsequent edition of this publication. Trademarks and trade names are shown in this publication for illustrative purposes only and are the property of their respective owners. The references to trademarks and trade names given herein do not affect their validity.

All photographs are used under license from Shutterstock, Inc. unless otherwise noted.

## **Illustrators and Image Sources**

1.1: Staff; 1.2: Staff; 1.3: Staff; 2.1: Staff; 2.2: Staff; 3.1: Staff; 3.2: Staff; 3.3: Staff; 4.1: Staff; 4.2: Staff; 4.3: Staff; 5.1: Staff; 5.2: Staff; 6.1: Staff; 6.2: Staff; 7.1: Staff; 7.2: Staff; 8.1: Staff; 8.2: Staff; 9.1: Staff; 9.2: Staff; 10.1: Staff; 10.2: Staff; 10.3: Shutterstock, Staff; 10.4: Staff; PP.1: Staff; PP.2: Staff; PP.3: Staff; PP.4: Staff; PP.5: Staff; PP.6: Staff; PP.7: Staff; PP.8: Staff; PP.9: Staff; PP.10: Staff; PP.12: Staff

Regarding the Shutterstock items listed above, please note: "No person or entity shall falsely represent, expressly or by way of reasonable implication, that the content herein was created by that person or entity, or any person other than the copyright holder(s) of that content.



**Kindergarten | Skills 2 | Activity Book**

ISBN 9781643837819



9 781643 837819