

Appendix C – TReX XSD Graphical Representation

Schema **TReX.v1.16.xsd**

schema location: <C:\Users\jreese\Desktop\TReX.v1.16.xsd>
attributeFormDefault: **unqualified**
elementFormDefault: **unqualified**
targetNamespace: **urn:us:tx:state:tea:TReX:v1.16**

Elements	Groups	Complex types	Simple types
TReXStudentRecords	PhoneNumberGroup	AcademicSessionType	AbbreviationType
		AcademicStatusType	AdditionalTestNameType
		AcademicSummaryType	AddressStringType
		AddressType	AdvancedMeasureType
		AssessmentSubTestType	AsyleeRefugeeCodeType
		AssessmentType	BilingualType
		AttendanceType	CareerTechEdType
		CourseType	CityType
		CurrentCourseworkType	ClassPeriodType
		DisciplineActionType	ClassRankType
		DistinguishedAchievementType	ClassTotalNumberType
		EnrollmentType	CollegeCampusCodeType
		EthnicityType	CountryType
		ImmunizationType	CourseCreditType
		ParentType	CourseExplanationType
		PerfAckApIbType	CourseGradeType
		PerfAckBilingBilitType	CourseIDType
		PerfAckCertLicType	CourseTeacherType
		PerfAckCollegeAssessType	CourseTitleType
		PerfAckDualCreditType	DaysType
		PersonNameType	DisciplineActionCodeType
		SchoolType	DisciplineActionNumType
		SpecialProgramsType	DisciplineActionReasonType
		StudentDemographicType	DistrictIDType
		StudentIdentificationType	DistrictNameType
		StudentRecordsType	EconomicDisadvantagedType
		StudentRecordType	ESLType
			EthnicityYesNoType
			FHSP
			FirstNameType
			FosterCareType
			GenderType

[GiftedTalentedType](#)
[GPAType](#)
[GradeLevelType](#)
[GraduationDiplomaTypeType](#)
[HomelessType](#)
[IGCCodeType](#)
[ImmunizationCodeType](#)
[ImmunizationDoseType](#)
[LanguageType](#)
[LastNameType](#)
[LEPType](#)
[LocalIDType](#)
[MiddleNameType](#)
[MilitaryConnectedType](#)
[ParticipationType](#)
[PassFailCreditType](#)
[PerfAckAplbCode](#)
[PerfAckBillingBilitCode](#)
[PerfAckCertLicCode](#)
[PerfAckCollegeAssessCode](#)
[PerfAckDualCreditCode](#)
[PerformanceLevelType](#)
[PhoneNumberType](#)
[PostalCodeType](#)
[PriorIDType](#)
[QuartileType](#)
[RaceType](#)
[SchoolIDType](#)
[SchoolNameType](#)
[SemesterSeqType](#)
[SemesterType](#)
[SessionTypeType](#)
[StateProvinceType](#)
[StudentIDType](#)
[StudentUniqueIDType](#)
[SubjectAreaType](#)
[SubTestNameType](#)
[SuffixType](#)
[TestCodeType](#)
[TestNameType](#)
[TestScoreType](#)
[TexasGrantType](#)
[TitleType](#)
[WithdrawGradeType](#)
[WithdrawReasonType](#)
[YearRangeType](#)

[YMDType](#)

[YMType](#)

element **TReXStudentRecords**

diagram	
namespace	urn:us:tx:state:tea:TREx:v1.16
type	trex:StudentRecordsType
properties	content complex
children	TReXStudentRecord
source	<code><xs:element name="TReXStudentRecords" type="trex:StudentRecordsType"/></code>

group **PhoneNumberGroup**

diagram	
namespace	urn:us:tx:state:tea:TREx:v1.16
children	PhoneNumber Fax
used by	complexType SchoolType
source	<pre> <xs:group name="PhoneNumberGroup"> <xs:sequence> <xs:element name="PhoneNumber" type="trex:PhoneNumberType"/> <xs:element name="Fax" type="trex:PhoneNumberType" minOccurs="0"/> </xs:sequence> </xs:group> </pre>

element **PhoneNumberGroup/PhoneNumber**

diagram										
type	trex:PhoneNumberType									
properties	content simple									
facets	<table border="1"> <thead> <tr> <th>Kind</th> <th>Value</th> <th>Annotation</th> </tr> </thead> <tbody> <tr> <td>minLength</td> <td>1</td> <td></td> </tr> <tr> <td>maxLength</td> <td>20</td> <td></td> </tr> </tbody> </table>	Kind	Value	Annotation	minLength	1		maxLength	20	
Kind	Value	Annotation								
minLength	1									
maxLength	20									

source	<code><xs:element name="PhoneNumber" type="trex:PhoneNumberType"/></code>
--------	---

element **PhoneNumberGroup/Fax**

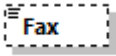
diagram	
type	trex:PhoneNumberType
properties	minOcc 0 maxOcc 1 content simple
facets	Kind Value Annotation minLength 1 maxLength 20
source	<code><xs:element name="Fax" type="trex:PhoneNumberType" minOccurs="0"/></code>

complexType **AcademicSessionType**

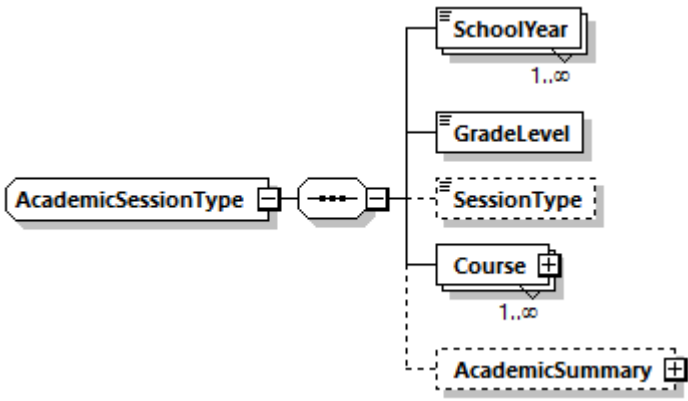
diagram	
namespace	urn:us:tx:state:tea:TREx:v1.16
children	SchoolYear GradeLevel SessionType Course AcademicSummary
used by	element StudentRecordType/AcademicSession
source	<pre><xs:complexType name="AcademicSessionType"> <xs:sequence> <xs:element name="SchoolYear" type="trex:YearRangeType" maxOccurs="unbounded"/> <xs:element name="GradeLevel" type="trex:GradeLevelType"/> <xs:element name="SessionType" type="trex:SessionTypeType" minOccurs="0"/> <xs:element name="Course" type="trex:CourseType" maxOccurs="unbounded"/> <xs:element name="AcademicSummary" type="trex:AcademicSummaryType" minOccurs="0"/> </xs:sequence> </xs:complexType></pre>

element **AcademicSessionType/SchoolYear**

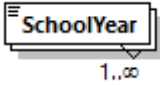
diagram	
type	trex:YearRangeType
properties	minOcc 1 maxOcc unbounded content simple
facets	Kind Value Annotation pattern [0-9]{4}-[0-9]{4}
source	<code><xs:element name="SchoolYear" type="trex:YearRangeType" maxOccurs="unbounded"/></code>

element **AcademicSessionType/GradeLevel**

diagram																																																	
type	trex:GradeLevelType																																																
properties	content simple																																																
facets	<table border="1"> <thead> <tr> <th>Kind</th> <th>Value</th> <th>Annotation</th> </tr> </thead> <tbody> <tr><td>enumeration</td><td>EE</td><td></td></tr> <tr><td>enumeration</td><td>PK</td><td></td></tr> <tr><td>enumeration</td><td>KG</td><td></td></tr> <tr><td>enumeration</td><td>01</td><td></td></tr> <tr><td>enumeration</td><td>02</td><td></td></tr> <tr><td>enumeration</td><td>03</td><td></td></tr> <tr><td>enumeration</td><td>04</td><td></td></tr> <tr><td>enumeration</td><td>05</td><td></td></tr> <tr><td>enumeration</td><td>06</td><td></td></tr> <tr><td>enumeration</td><td>07</td><td></td></tr> <tr><td>enumeration</td><td>08</td><td></td></tr> <tr><td>enumeration</td><td>09</td><td></td></tr> <tr><td>enumeration</td><td>10</td><td></td></tr> <tr><td>enumeration</td><td>11</td><td></td></tr> <tr><td>enumeration</td><td>12</td><td></td></tr> </tbody> </table>	Kind	Value	Annotation	enumeration	EE		enumeration	PK		enumeration	KG		enumeration	01		enumeration	02		enumeration	03		enumeration	04		enumeration	05		enumeration	06		enumeration	07		enumeration	08		enumeration	09		enumeration	10		enumeration	11		enumeration	12	
Kind	Value	Annotation																																															
enumeration	EE																																																
enumeration	PK																																																
enumeration	KG																																																
enumeration	01																																																
enumeration	02																																																
enumeration	03																																																
enumeration	04																																																
enumeration	05																																																
enumeration	06																																																
enumeration	07																																																
enumeration	08																																																
enumeration	09																																																
enumeration	10																																																
enumeration	11																																																
enumeration	12																																																
source	<code><xs:element name="GradeLevel" type="trex:GradeLevelType"/></code>																																																

element **AcademicSessionType/SessionType**

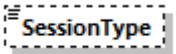
diagram	
type	trex:SessionTypeType
properties	minOcc 0 maxOcc 1 content simple

facets	Kind enumeration	Value Semester	Annotation
	enumeration	Trimester	
	enumeration	Quarter	
source	<code><xs:element name="SessionType" type="trex:SessionTypeType" minOccurs="0"/></code>		

element **AcademicSessionType/Course**

diagram	
type	trex:CourseType
properties	minOcc 1 maxOcc unbounded content complex

children	CourseTitle CourseID Abbreviation Semester ClassPeriod SubjectArea CourseGrade WithdrawGrade GradeAverage CourseCredit PassFailCredit Explanation CourseTeacher CreditCampus SemesterSeq FinalGradeAverage
source	<code><xs:element name="Course" type="trex:CourseType" maxOccurs="unbounded"/></code>

element **AcademicSessionType/AcademicSummary**

diagram	<p>The diagram illustrates the XSD structure for the <code>AcademicSummary</code> element. It shows a root element <code>AcademicSummary</code> (represented by a dashed box) containing a complex content type <code>trex:AcademicSummaryType</code> (represented by a yellow dashed box). Inside <code>trex:AcademicSummaryType</code>, there are six child elements: <code>GPA</code>, <code>ClassTotalNumber</code>, <code>ClassRank</code>, <code>ClassRankingDate</code>, <code>Quartile</code>, and <code>CollegeCampusCode</code>. Each child element is shown in a dashed box with a small icon indicating its cardinality (1).</p>
type	trex:AcademicSummaryType
properties	minOcc 0 maxOcc 1 content complex
children	GPA ClassTotalNumber ClassRank ClassRankingDate Quartile CollegeCampusCode
source	<code><xs:element name="AcademicSummary" type="trex:AcademicSummaryType" minOccurs="0"/></code>

complexType **AcademicStatusType**

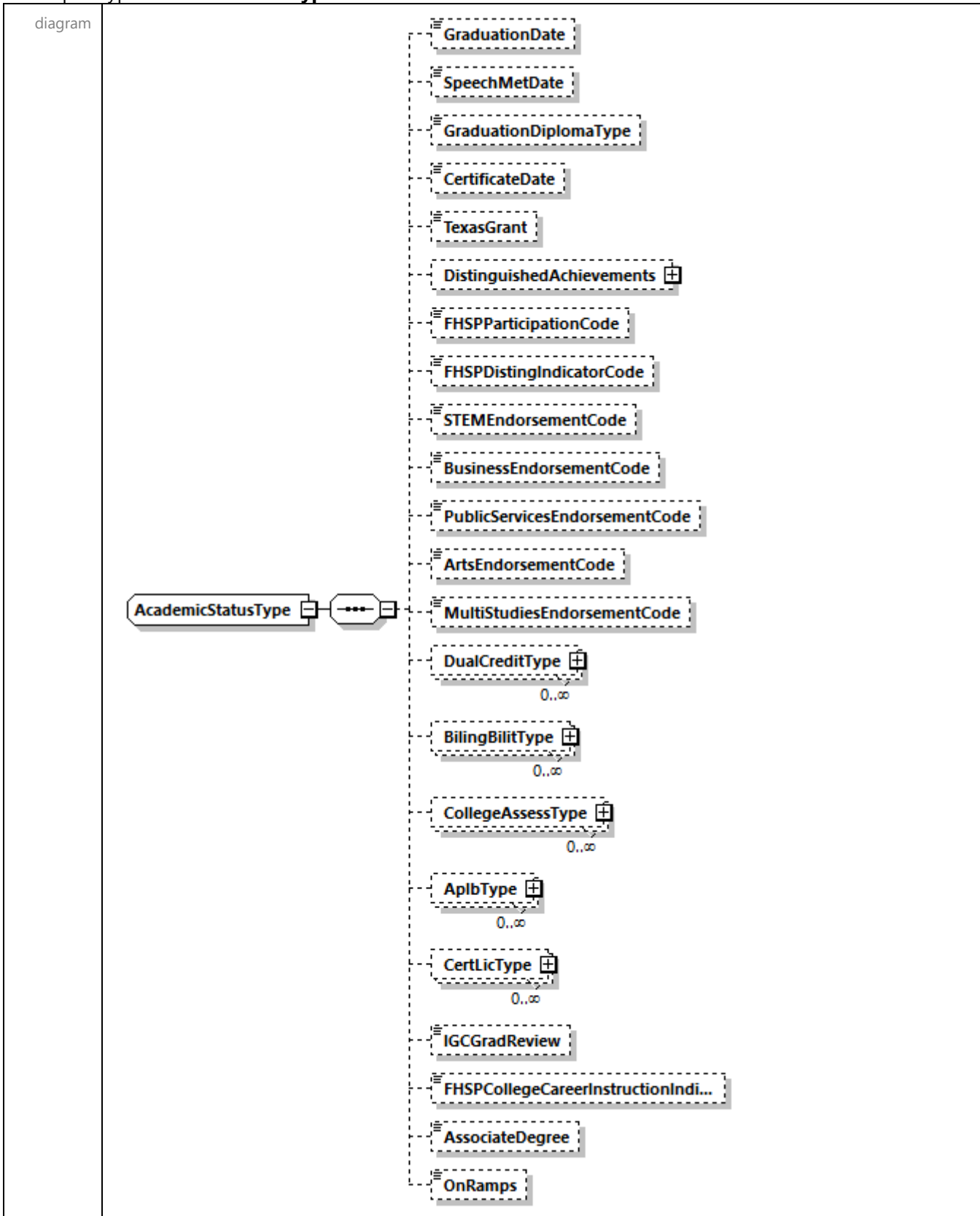

namespace	urn:us:tx:state:tea:TREx:v1.16
children	GraduationDate SpeechMetDate GraduationDiplomaType CertificateDate TexasGrant DistinguishedAchievements FHSPParticipationCode FHSPDistingIndicatorCode STEMEndorsementCode BusinessEndorsementCode PublicServicesEndorsementCode ArtsEndorsementCode MultiStudiesEndorsementCode DualCreditType BilingBilitType CollegeAssesType ApIbType CertLicType IGCGradReview FHSPCollegeCareerInstructionIndicator AssociateDegree OnRamps
used by	element StudentRecordType/AcademicStatus
source	<pre> <xs:complexType name="AcademicStatusType"> <xs:sequence> <xs:element name="GraduationDate" type="trex:YMType" minOccurs="0"/> <xs:element name="SpeechMetDate" type="trex:YMType" minOccurs="0"/> <xs:element name="GraduationDiplomaType" type="trex:GraduationDiplomaTypeType" minOccurs="0"/> <xs:element name="CertificateDate" type="trex:YMDType" minOccurs="0"/> <xs:element name="TexasGrant" type="trex:TexasGrantType" minOccurs="0"/> <xs:element name="DistinguishedAchievements" type="trex:DistinguishedAchievementType" minOccurs="0" maxOccurs="1"/> <xs:element name="FHSPParticipationCode" type="trex:FHSP" minOccurs="0"/> <xs:element name="FHSPDistingIndicatorCode" type="trex:FHSP" minOccurs="0"/> <xs:element name="STEMEndorsementCode" type="trex:FHSP" minOccurs="0"/> <xs:element name="BusinessEndorsementCode" type="trex:FHSP" minOccurs="0"/> <xs:element name="PublicServicesEndorsementCode" type="trex:FHSP" minOccurs="0"/> <xs:element name="ArtsEndorsementCode" type="trex:FHSP" minOccurs="0"/> <xs:element name="MultiStudiesEndorsementCode" type="trex:FHSP" minOccurs="0"/> <xs:element name="DualCreditType" type="trex:PerfAckDualCreditType" minOccurs="0" maxOccurs="unbounded"/> <xs:element name="BilingBilitType" type="trex:PerfAckBilingBilitType" minOccurs="0" maxOccurs="unbounded"/> <xs:element name="CollegeAssesType" type="trex:PerfAckCollegeAssesType" minOccurs="0" maxOccurs="unbounded"/> <xs:element name="ApIbType" type="trex:PerfAckApIbType" minOccurs="0" maxOccurs="unbounded"/> <xs:element name="CertLicType" type="trex:PerfAckCertLicType" minOccurs="0" maxOccurs="unbounded"/> <xs:element name="IGCGradReview" type="trex:IGCCodeType" minOccurs="0"/> <xs:element name="FHSPCollegeCareerInstructionIndicator" type="trex:ParticipationType" minOccurs="0"/> <xs:element name="AssociateDegree" type="trex:ParticipationType" minOccurs="0"/> <xs:element name="OnRamps" type="trex:ParticipationType" minOccurs="0"/> </xs:sequence> </xs:complexType> </pre>

element **AcademicStatusType/GraduationDate**

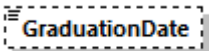
diagram	
type	trex:YMType

properties	minOcc 0 maxOcc 1 content simple
facets	Kind Value Annotation pattern [0-9]{4}-[01]?[0-9]
source	<code><xs:element name="GraduationDate" type="trex:YMType" minOccurs="0"/></code>

element **AcademicStatusType/SpeechMetDate**

diagram	
type	trex:YMType
properties	minOcc 0 maxOcc 1 content simple
facets	Kind Value Annotation pattern [0-9]{4}-[01]?[0-9]
source	<code><xs:element name="SpeechMetDate" type="trex:YMType" minOccurs="0"/></code>

element **AcademicStatusType/GraduationDiplomaType**

diagram																																																										
type	trex:GraduationDiplomaType																																																									
properties	minOcc 0 maxOcc 1 content simple																																																									
facets	<table border="0"> <thead> <tr> <th>Kind</th> <th>Value</th> <th>Annotation</th> </tr> </thead> <tbody> <tr><td>enumeration</td><td>04</td><td></td></tr> <tr><td>enumeration</td><td>05</td><td></td></tr> <tr><td>enumeration</td><td>06</td><td></td></tr> <tr><td>enumeration</td><td>07</td><td></td></tr> <tr><td>enumeration</td><td>13</td><td></td></tr> <tr><td>enumeration</td><td>15</td><td></td></tr> <tr><td>enumeration</td><td>17</td><td></td></tr> <tr><td>enumeration</td><td>18</td><td></td></tr> <tr><td>enumeration</td><td>19</td><td></td></tr> <tr><td>enumeration</td><td>20</td><td></td></tr> <tr><td>enumeration</td><td>21</td><td></td></tr> <tr><td>enumeration</td><td>22</td><td></td></tr> <tr><td>enumeration</td><td>23</td><td></td></tr> <tr><td>enumeration</td><td>24</td><td></td></tr> <tr><td>enumeration</td><td>25</td><td></td></tr> <tr><td>enumeration</td><td>26</td><td></td></tr> <tr><td>enumeration</td><td>27</td><td></td></tr> <tr><td>enumeration</td><td>28</td><td></td></tr> </tbody> </table>	Kind	Value	Annotation	enumeration	04		enumeration	05		enumeration	06		enumeration	07		enumeration	13		enumeration	15		enumeration	17		enumeration	18		enumeration	19		enumeration	20		enumeration	21		enumeration	22		enumeration	23		enumeration	24		enumeration	25		enumeration	26		enumeration	27		enumeration	28	
Kind	Value	Annotation																																																								
enumeration	04																																																									
enumeration	05																																																									
enumeration	06																																																									
enumeration	07																																																									
enumeration	13																																																									
enumeration	15																																																									
enumeration	17																																																									
enumeration	18																																																									
enumeration	19																																																									
enumeration	20																																																									
enumeration	21																																																									
enumeration	22																																																									
enumeration	23																																																									
enumeration	24																																																									
enumeration	25																																																									
enumeration	26																																																									
enumeration	27																																																									
enumeration	28																																																									

	enumeration 29 enumeration 30 enumeration 31 enumeration 32 enumeration 33 enumeration 34 enumeration 35 enumeration 54 enumeration 55 enumeration 56 enumeration 57
source	<code><xs:element name="GraduationDiplomaType" type="trex:GraduationDiplomaTypeType" minOccurs="0"/></code>

element **AcademicStatusType/CertificateDate**

diagram	
type	trex:YMDType
properties	minOcc 0 maxOcc 1 content simple
facets	Kind Value Annotation pattern [0-9]{4}-[01]?[0-9]-[0123]?[0-9]
source	<code><xs:element name="CertificateDate" type="trex:YMDType" minOccurs="0"/></code>

element **AcademicStatusType/TexasGrant**

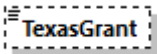
diagram	
type	trex:TexasGrantType
properties	minOcc 0 maxOcc 1 content simple
facets	Kind Value Annotation enumeration 1 enumeration 2 enumeration 3 enumeration 4 enumeration 5
source	<code><xs:element name="TexasGrant" type="trex:TexasGrantType" minOccurs="0"/></code>

element **AcademicStatusType/DistinguishedAchievements**

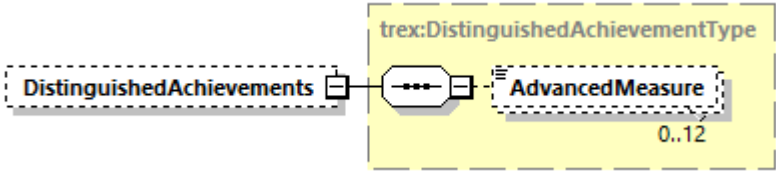
diagram	
type	trex:DistinguishedAchievementType
properties	minOcc 0 maxOcc 1 content complex
children	AdvancedMeasure
source	<code><xs:element name="DistinguishedAchievements" type="trex:DistinguishedAchievementType" minOccurs="0" maxOccurs="1"/></code>

element **AcademicStatusType/FHSPParticipationCode**

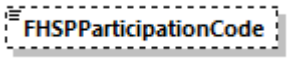
diagram													
type	trex:FHSP												
properties	minOcc 0 maxOcc 1 content simple												
facets	<table border="1"> <thead> <tr> <th>Kind</th> <th>Value</th> <th>Annotation</th> </tr> </thead> <tbody> <tr> <td>enumeration</td> <td>0</td> <td></td> </tr> <tr> <td>enumeration</td> <td>1</td> <td></td> </tr> <tr> <td>enumeration</td> <td>2</td> <td></td> </tr> </tbody> </table>	Kind	Value	Annotation	enumeration	0		enumeration	1		enumeration	2	
Kind	Value	Annotation											
enumeration	0												
enumeration	1												
enumeration	2												
source	<code><xs:element name="FHSPParticipationCode" type="trex:FHSP" minOccurs="0"/></code>												

element **AcademicStatusType/FHSPDistingIndicatorCode**

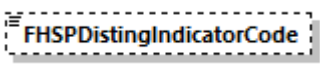
diagram													
type	trex:FHSP												
properties	minOcc 0 maxOcc 1 content simple												
facets	<table border="1"> <thead> <tr> <th>Kind</th> <th>Value</th> <th>Annotation</th> </tr> </thead> <tbody> <tr> <td>enumeration</td> <td>0</td> <td></td> </tr> <tr> <td>enumeration</td> <td>1</td> <td></td> </tr> <tr> <td>enumeration</td> <td>2</td> <td></td> </tr> </tbody> </table>	Kind	Value	Annotation	enumeration	0		enumeration	1		enumeration	2	
Kind	Value	Annotation											
enumeration	0												
enumeration	1												
enumeration	2												
source	<code><xs:element name="FHSPDistingIndicatorCode" type="trex:FHSP" minOccurs="0"/></code>												

element **AcademicStatusType/STEMEndorsementCode**

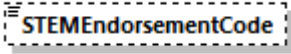
diagram	
type	trex:FHSP
properties	minOcc 0 maxOcc 1 content simple
facets	Kind Value Annotation enumeration 0 enumeration 1 enumeration 2
source	<code><xs:element name="STEMEndorsementCode" type="trex:FHSP" minOccurs="0"/></code>

element **AcademicStatusType/BusinessEndorsementCode**

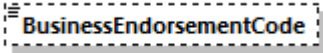
diagram	
type	trex:FHSP
properties	minOcc 0 maxOcc 1 content simple
facets	Kind Value Annotation enumeration 0 enumeration 1 enumeration 2
source	<code><xs:element name="BusinessEndorsementCode" type="trex:FHSP" minOccurs="0"/></code>

element **AcademicStatusType/PublicServicesEndorsementCode**

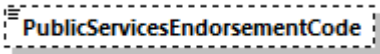
diagram	
type	trex:FHSP
properties	minOcc 0 maxOcc 1 content simple
facets	Kind Value Annotation enumeration 0 enumeration 1 enumeration 2
source	<code><xs:element name="PublicServicesEndorsementCode" type="trex:FHSP" minOccurs="0"/></code>

element **AcademicStatusType/ArtsEndorsementCode**

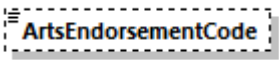
diagram	
type	trex:FHSP
properties	minOcc 0 maxOcc 1 content simple
facets	Kind Value Annotation enumeration 0 enumeration 1 enumeration 2
source	<code><xs:element name="ArtsEndorsementCode" type="trex:FHSP" minOccurs="0"/></code>

element **AcademicStatusType/MultiStudiesEndorsementCode**

diagram	
type	trex:FHSP
properties	minOcc 0 maxOcc 1 content simple
facets	Kind Value Annotation enumeration 0 enumeration 1 enumeration 2
source	<code><xs:element name="MultiStudiesEndorsementCode" type="trex:FHSP" minOccurs="0"/></code>

element **AcademicStatusType/DualCreditType**

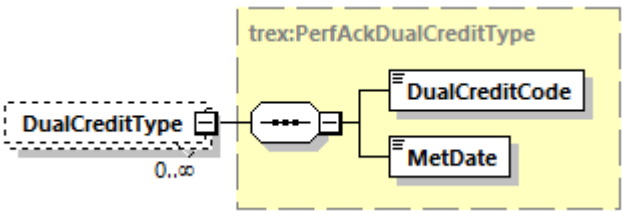
diagram	
type	trex:PerfAckDualCreditType
properties	minOcc 0 maxOcc unbounded content complex
children	DualCreditCode MetDate
source	<code><xs:element name="DualCreditType" type="trex:PerfAckDualCreditType" minOccurs="0" maxOccurs="unbounded"/></code>

element **AcademicStatusType/BilingBilitType**

diagram	
type	trex:PerfAckBilingBilitType
properties	minOcc 0 maxOcc unbounded content complex
children	BilingBilitCode MetDate
source	<pre><xs:element name="BilingBilitType" type="trex:PerfAckBilingBilitType" minOccurs="0" maxOccurs="unbounded"/></pre>

element **AcademicStatusType/CollegeAssesType**

diagram	
type	trex:PerfAckCollegeAssesType
properties	minOcc 0 maxOcc unbounded content complex
children	CollegeAssesCode MetDate
source	<pre><xs:element name="CollegeAssesType" type="trex:PerfAckCollegeAssesType" minOccurs="0" maxOccurs="unbounded"/></pre>

element **AcademicStatusType/AplbType**

diagram	
type	trex:PerfAckAplbType
properties	minOcc 0 maxOcc unbounded content complex
children	AplbCode MetDate

source	<code><xs:element name="ApIbType" type="trex:PerfAckApIbType" minOccurs="0" maxOccurs="unbounded"/></code>
--------	--

element **AcademicStatusType/CertLicType**

diagram	
type	trex:PerfAckCertLicType
properties	minOcc 0 maxOcc unbounded content complex
children	CertLicCode MetDate
source	<code><xs:element name="CertLicType" type="trex:PerfAckCertLicType" minOccurs="0" maxOccurs="unbounded"/></code>

element **AcademicStatusType/IGCGradReview**

diagram										
type	trex:IGCCodeType									
properties	minOcc 0 maxOcc 1 content simple									
facets	<table border="1"> <thead> <tr> <th>Kind</th> <th>Value</th> <th>Annotation</th> </tr> </thead> <tbody> <tr> <td>enumeration</td> <td>00</td> <td></td> </tr> <tr> <td>enumeration</td> <td>01</td> <td></td> </tr> </tbody> </table>	Kind	Value	Annotation	enumeration	00		enumeration	01	
Kind	Value	Annotation								
enumeration	00									
enumeration	01									
source	<code><xs:element name="IGCGradReview" type="trex:IGCCodeType" minOccurs="0"/></code>									

element **AcademicStatusType/FHSPCollegeCareerInstructionIndicator**

diagram										
type	trex:ParticipationType									
properties	minOcc 0 maxOcc 1 content simple									
facets	<table border="1"> <thead> <tr> <th>Kind</th> <th>Value</th> <th>Annotation</th> </tr> </thead> <tbody> <tr> <td>enumeration</td> <td>0</td> <td></td> </tr> <tr> <td>enumeration</td> <td>1</td> <td></td> </tr> </tbody> </table>	Kind	Value	Annotation	enumeration	0		enumeration	1	
Kind	Value	Annotation								
enumeration	0									
enumeration	1									
source	<code><xs:element name="FHSPCollegeCareerInstructionIndicator"</code>									

	<code>type="trex:ParticipationType" minOccurs="0"/></code>
--	---

element **AcademicStatusType/AssociateDegree**

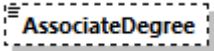
diagram										
type	trex:ParticipationType									
properties	minOcc 0 maxOcc 1 content simple									
facets	<table border="1"> <thead> <tr> <th>Kind</th> <th>Value</th> <th>Annotation</th> </tr> </thead> <tbody> <tr> <td>enumeration</td> <td>0</td> <td></td> </tr> <tr> <td>enumeration</td> <td>1</td> <td></td> </tr> </tbody> </table>	Kind	Value	Annotation	enumeration	0		enumeration	1	
Kind	Value	Annotation								
enumeration	0									
enumeration	1									
source	<code><xs:element name="AssociateDegree" type="trex:ParticipationType" minOccurs="0"/></code>									

element **AcademicStatusType/OnRamps**

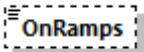
diagram										
type	trex:ParticipationType									
properties	minOcc 0 maxOcc 1 content simple									
facets	<table border="1"> <thead> <tr> <th>Kind</th> <th>Value</th> <th>Annotation</th> </tr> </thead> <tbody> <tr> <td>enumeration</td> <td>0</td> <td></td> </tr> <tr> <td>enumeration</td> <td>1</td> <td></td> </tr> </tbody> </table>	Kind	Value	Annotation	enumeration	0		enumeration	1	
Kind	Value	Annotation								
enumeration	0									
enumeration	1									
source	<code><xs:element name="OnRamps" type="trex:ParticipationType" minOccurs="0"/></code>									

complexType **AcademicSummaryType**

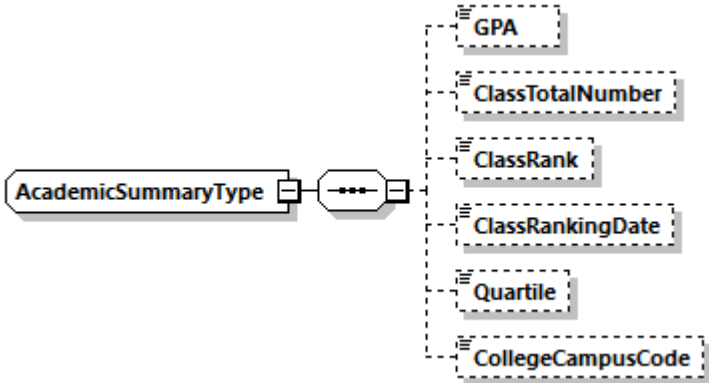
diagram	
namespace	urn:us:tx:state:tea:TREx:v1.16
children	GPA ClassTotalNumber ClassRank ClassRankingDate Quartile CollegeCampusCode
used by	elements AcademicSessionType/AcademicSummary StudentRecordType/AcademicSummary

source	<pre><xs:complexType name="AcademicSummaryType"> <xs:sequence> <xs:element name="GPA" type="trex:GPAType" minOccurs="0"/> <xs:element name="ClassTotalNumber" type="trex:ClassTotalNumberType" minOccurs="0"/> <xs:element name="ClassRank" type="trex:ClassRankType" minOccurs="0"/> <xs:element name="ClassRankingDate" type="trex:YMDType" minOccurs="0"/> <xs:element name="Quartile" type="trex:QuartileType" minOccurs="0"/> <xs:element name="CollegeCampusCode" type="trex:CollegeCampusCodeType" minOccurs="0"/> </xs:sequence> </xs:complexType></pre>
--------	--

element **AcademicSummaryType/GPA**

diagram										
type	trex:GPAType									
properties	minOcc 0 maxOcc 1 content simple									
facets	<table border="1"> <thead> <tr> <th>Kind</th> <th>Value</th> <th>Annotation</th> </tr> </thead> <tbody> <tr> <td>minLength</td> <td>1</td> <td></td> </tr> <tr> <td>maxLength</td> <td>10</td> <td></td> </tr> </tbody> </table>	Kind	Value	Annotation	minLength	1		maxLength	10	
Kind	Value	Annotation								
minLength	1									
maxLength	10									
source	<pre><xs:element name="GPA" type="trex:GPAType" minOccurs="0"/></pre>									

element **AcademicSummaryType/ClassTotalNumber**

diagram							
type	trex:ClassTotalNumberType						
properties	minOcc 0 maxOcc 1 content simple						
facets	<table border="1"> <thead> <tr> <th>Kind</th> <th>Value</th> <th>Annotation</th> </tr> </thead> <tbody> <tr> <td>totalDigits</td> <td>5</td> <td></td> </tr> </tbody> </table>	Kind	Value	Annotation	totalDigits	5	
Kind	Value	Annotation					
totalDigits	5						
source	<pre><xs:element name="ClassTotalNumber" type="trex:ClassTotalNumberType" minOccurs="0"/></pre>						

element **AcademicSummaryType/ClassRank**

diagram	
type	trex:ClassRankType
properties	minOcc 0 maxOcc 1 content simple

facets	Kind Value Annotation totalDigits 5
source	<code><xs:element name="ClassRank" type="trex:ClassRankType" minOccurs="0"/></code>

element **AcademicSummaryType/ClassRankingDate**

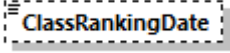
diagram	
type	trex:YMDType
properties	minOcc 0 maxOcc 1 content simple
facets	Kind Value Annotation pattern [0-9]{4}-[01]?[0-9]-[0123]?[0-9]
source	<code><xs:element name="ClassRankingDate" type="trex:YMDType" minOccurs="0"/></code>

element **AcademicSummaryType/Quartile**

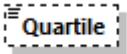
diagram	
type	trex:QuartileType
properties	minOcc 0 maxOcc 1 content simple
facets	Kind Value Annotation enumeration 1 enumeration 2 enumeration 3 enumeration 4
source	<code><xs:element name="Quartile" type="trex:QuartileType" minOccurs="0"/></code>

element **AcademicSummaryType/CollegeCampusCode**

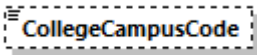
diagram	
type	trex:CollegeCampusCodeType
properties	minOcc 0 maxOcc 1 content simple
facets	Kind Value Annotation pattern ([0-9]{6})
source	<code><xs:element name="CollegeCampusCode" type="trex:CollegeCampusCodeType" minOccurs="0"/></code>

complexType **AddressType**

diagram	<p>The diagram shows a complex type named 'AddressType' connected to a sequence container. This container lists five child elements: 'Address', 'City', 'StateProvince', 'Country', and 'PostalCode'.</p>
namespace	urn:us:tx:state:tea:TREx:v1.16
children	Address City StateProvince Country PostalCode
used by	elements SchoolType/Address StudentIdentificationType/Address
source	<pre><xs:complexType name="AddressType"> <xs:sequence> <xs:element name="Address" type="trex:AddressStringType" minOccurs="0"/> <xs:element name="City" type="trex:CityType" minOccurs="0"/> <xs:element name="StateProvince" type="trex:StateProvinceType" minOccurs="0"/> <xs:element name="Country" type="trex:CountryType" minOccurs="0"/> <xs:element name="PostalCode" type="trex:PostalCodeType" minOccurs="0"/> </xs:sequence> </xs:complexType></pre>

element **AddressType/Address**

diagram	<p>The diagram shows a single element named 'Address'.</p>									
type	trex:AddressStringType									
properties	minOcc 0 maxOcc 1 content simple									
facets	<table border="1"> <thead> <tr> <th>Kind</th> <th>Value</th> <th>Annotation</th> </tr> </thead> <tbody> <tr> <td>minLength</td> <td>1</td> <td></td> </tr> <tr> <td>maxLength</td> <td>50</td> <td></td> </tr> </tbody> </table>	Kind	Value	Annotation	minLength	1		maxLength	50	
Kind	Value	Annotation								
minLength	1									
maxLength	50									
source	<pre><xs:element name="Address" type="trex:AddressStringType" minOccurs="0"/></pre>									

element **AddressType/City**

diagram	<p>The diagram shows a single element named 'City'.</p>
type	trex:CityType
properties	minOcc 0 maxOcc 1 content simple

facets	Kind	Value	Annotation
	minLength	1	
	maxLength	30	
source	<code><xs:element name="City" type="trex:CityType" minOccurs="0"/></code>		

element **AddressType/StateProvince**

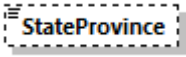
diagram			
type	trex:StateProvinceType		
properties	minOcc	0	
	maxOcc	1	
	content	simple	
facets	Kind	Value	Annotation
	enumeration	TX	
	enumeration	AA	
	enumeration	AB	
	enumeration	AE	
	enumeration	AK	
	enumeration	AL	
	enumeration	AP	
	enumeration	AR	
	enumeration	AS	
	enumeration	AZ	
	enumeration	BC	
	enumeration	CA	
	enumeration	CO	
	enumeration	CT	
	enumeration	CZ	
	enumeration	DC	
	enumeration	DE	
	enumeration	FL	
	enumeration	FM	
	enumeration	GA	
	enumeration	GU	
	enumeration	HI	
	enumeration	IA	
	enumeration	ID	
	enumeration	IL	
	enumeration	IN	
	enumeration	KS	
	enumeration	KY	
	enumeration	LA	
	enumeration	MA	
	enumeration	MB	

enumeration	MD
enumeration	ME
enumeration	MH
enumeration	MI
enumeration	MN
enumeration	MO
enumeration	MP
enumeration	MS
enumeration	MT
enumeration	NB
enumeration	NC
enumeration	ND
enumeration	NE
enumeration	NF
enumeration	NH
enumeration	NJ
enumeration	NL
enumeration	NM
enumeration	NS
enumeration	NT
enumeration	NU
enumeration	NV
enumeration	NY
enumeration	OH
enumeration	OK
enumeration	ON
enumeration	OR
enumeration	PA
enumeration	PE
enumeration	PR
enumeration	PW
enumeration	QC
enumeration	RI
enumeration	SC
enumeration	SD
enumeration	SK
enumeration	TN
enumeration	UT
enumeration	VA
enumeration	VI
enumeration	VT
enumeration	WA
enumeration	WI
enumeration	WV
enumeration	WY

	enumeration YT
source	<code><xs:element name="StateProvince" type="trex:StateProvinceType" minOccurs="0"/></code>

element **AddressType/Country**

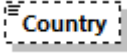
diagram			
type	trex:CountryType		
properties	minOcc	0	
	maxOcc	1	
	content	simple	
facets	Kind	Value	Annotation
	enumeration	US	
	enumeration	AD	
	enumeration	AE	
	enumeration	AF	
	enumeration	AG	
	enumeration	AI	
	enumeration	AL	
	enumeration	AM	
	enumeration	AN	
	enumeration	AO	
	enumeration	AQ	
	enumeration	AR	
	enumeration	AS	
	enumeration	AT	
	enumeration	AU	
	enumeration	AW	
	enumeration	AX	
	enumeration	AZ	
	enumeration	BA	
	enumeration	BB	
	enumeration	BD	
	enumeration	BE	
	enumeration	BF	
	enumeration	BG	
	enumeration	BH	
	enumeration	BI	
	enumeration	BJ	
	enumeration	BM	
	enumeration	BN	
	enumeration	BO	
	enumeration	BR	
	enumeration	BS	
	enumeration	BT	

enumeration	BV
enumeration	BW
enumeration	BY
enumeration	BZ
enumeration	CA
enumeration	CC
enumeration	CD
enumeration	CF
enumeration	CG
enumeration	CH
enumeration	CI
enumeration	CK
enumeration	CL
enumeration	CM
enumeration	CN
enumeration	CO
enumeration	CR
enumeration	CS
enumeration	CU
enumeration	CV
enumeration	CX
enumeration	CY
enumeration	CZ
enumeration	DE
enumeration	DJ
enumeration	DK
enumeration	DM
enumeration	DO
enumeration	DZ
enumeration	EC
enumeration	EE
enumeration	EG
enumeration	EH
enumeration	ER
enumeration	ES
enumeration	ET
enumeration	FI
enumeration	FJ
enumeration	FK
enumeration	FM
enumeration	FO
enumeration	FR
enumeration	GA
enumeration	GB
enumeration	GD

enumeration	GE
enumeration	GF
enumeration	GH
enumeration	GI
enumeration	GL
enumeration	GM
enumeration	GN
enumeration	GP
enumeration	GQ
enumeration	GR
enumeration	GS
enumeration	GT
enumeration	GU
enumeration	GW
enumeration	GY
enumeration	HK
enumeration	HM
enumeration	HN
enumeration	HR
enumeration	HT
enumeration	HU
enumeration	ID
enumeration	IE
enumeration	IL
enumeration	IN
enumeration	IO
enumeration	IQ
enumeration	IR
enumeration	IS
enumeration	IT
enumeration	JM
enumeration	JO
enumeration	JP
enumeration	KE
enumeration	KG
enumeration	KH
enumeration	KI
enumeration	KM
enumeration	KN
enumeration	KP
enumeration	KR
enumeration	KW
enumeration	KY
enumeration	KZ
enumeration	LA

enumeration	LB
enumeration	LC
enumeration	LI
enumeration	LK
enumeration	LR
enumeration	LS
enumeration	LT
enumeration	LU
enumeration	LV
enumeration	LY
enumeration	MA
enumeration	MC
enumeration	MD
enumeration	MG
enumeration	MH
enumeration	MK
enumeration	ML
enumeration	MM
enumeration	MN
enumeration	MO
enumeration	MP
enumeration	MQ
enumeration	MR
enumeration	MS
enumeration	MT
enumeration	MU
enumeration	MV
enumeration	MW
enumeration	MX
enumeration	MY
enumeration	MZ
enumeration	NA
enumeration	NC
enumeration	NE
enumeration	NF
enumeration	NG
enumeration	NI
enumeration	NL
enumeration	NO
enumeration	NP
enumeration	NR
enumeration	NU
enumeration	NZ
enumeration	OM
enumeration	PA

enumeration	PE
enumeration	PF
enumeration	PG
enumeration	PH
enumeration	PK
enumeration	PL
enumeration	PM
enumeration	PN
enumeration	PR
enumeration	PS
enumeration	PT
enumeration	PW
enumeration	PY
enumeration	QA
enumeration	RE
enumeration	RO
enumeration	RU
enumeration	RW
enumeration	SA
enumeration	SB
enumeration	SC
enumeration	SD
enumeration	SE
enumeration	SG
enumeration	SH
enumeration	SI
enumeration	SJ
enumeration	SK
enumeration	SL
enumeration	SM
enumeration	SN
enumeration	SO
enumeration	SR
enumeration	ST
enumeration	SV
enumeration	SY
enumeration	SZ
enumeration	TC
enumeration	TD
enumeration	TF
enumeration	TG
enumeration	TH
enumeration	TJ
enumeration	TK
enumeration	TL

	enumeration TM enumeration TN enumeration TO enumeration TR enumeration TT enumeration TV enumeration TW enumeration TZ enumeration UA enumeration UG enumeration UM enumeration UY enumeration UZ enumeration VA enumeration VC enumeration VE enumeration VG enumeration VI enumeration VN enumeration VU enumeration WF enumeration WS enumeration YE enumeration YT enumeration ZA enumeration ZM enumeration ZW
source	<code><xs:element name="Country" type="trex:CountryType" minOccurs="0"/></code>

element **AddressType/PostalCode**

diagram													
type	trex:PostalCodeType												
properties	minOcc 0 maxOcc 1 content simple												
facets	<table border="0"> <thead> <tr> <th>Kind</th> <th>Value</th> <th>Annotation</th> </tr> </thead> <tbody> <tr> <td>minLength</td> <td>5</td> <td></td> </tr> <tr> <td>maxLength</td> <td>10</td> <td></td> </tr> <tr> <td>pattern</td> <td>(([0-9]{5}) ([0-9]{5}-[0-9]{4}))</td> <td></td> </tr> </tbody> </table>	Kind	Value	Annotation	minLength	5		maxLength	10		pattern	(([0-9]{5}) ([0-9]{5}-[0-9]{4}))	
Kind	Value	Annotation											
minLength	5												
maxLength	10												
pattern	(([0-9]{5}) ([0-9]{5}-[0-9]{4}))												
source	<code><xs:element name="PostalCode" type="trex:PostalCodeType" minOccurs="0"/></code>												

complexType **AssessmentSubTestType**

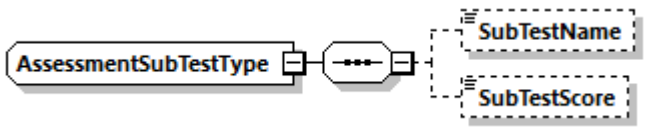
diagram	
namespace	urn:us:tx:state:tea:TREx:v1.16
children	SubTestName SubTestScore
used by	element AssessmentType/AssessmentSubTest
source	<pre><xs:complexType name="AssessmentSubTestType"> <xs:sequence> <xs:element name="SubTestName" type="trex:SubTestNameType" minOccurs="0"/> <xs:element name="SubTestScore" type="trex:TestScoreType" minOccurs="0"/> </xs:sequence> </xs:complexType></pre>

element **AssessmentSubTestType/SubTestName**

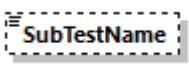
diagram	
type	trex:SubTestNameType
properties	minOcc 0 maxOcc 1 content simple
facets	Kind Value Annotation minLength 1 maxLength 60
source	<pre><xs:element name="SubTestName" type="trex:SubTestNameType" minOccurs="0"/></pre>

element **AssessmentSubTestType/SubTestScore**

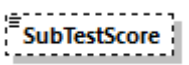
diagram	
type	trex:TestScoreType
properties	minOcc 0 maxOcc 1 content simple
facets	Kind Value Annotation minLength 1 maxLength 6
source	<pre><xs:element name="SubTestScore" type="trex:TestScoreType" minOccurs="0"/></pre>

complexType **AssessmentType**

diagram	
namespace	urn:us:tx:state:tea:TREx:v1.16
children	TestName AdditionalTestName TestLevel TestDate ExitRequirementMetDate TestScore TestCode PerformanceLevel AssessmentSubTest
used by	element StudentRecordType/Assessment
source	<pre> <xs:complexType name="AssessmentType"> <xs:sequence> <xs:choice> <xs:element name="TestName" type="trex:TestNameType" minOccurs="0"/> <xs:element name="AdditionalTestName" type="trex:AdditionalTestNameType" minOccurs="0"/> </xs:choice> <xs:element name="TestLevel" type="trex:GradeLevelType" minOccurs="0"/> <xs:element name="TestDate" type="trex:YMTType" minOccurs="0"/> <xs:element name="ExitRequirementMetDate" type="trex:YMTType" minOccurs="0"/> <xs:element name="TestScore" type="trex:TestScoreType" minOccurs="0"/> <xs:element name="TestCode" type="trex:TestCodeType" minOccurs="0"/> <xs:element name="PerformanceLevel" type="trex:PerformanceLevelType" minOccurs="0"/> <xs:element name="AssessmentSubTest" type="trex:AssessmentSubTestType" minOccurs="0" maxOccurs="unbounded"/> </xs:sequence> </xs:complexType> </pre>

element **AssessmentType/TestName**

diagram	
type	trex:TestNameType

properties	minOcc 0 maxOcc 1 content simple		
facets	Kind	Value	Annotation
	enumeration	01	
	enumeration	02	
	enumeration	03	
	enumeration	04	
	enumeration	05	
	enumeration	06	
	enumeration	07	
	enumeration	08	
	enumeration	09	
	enumeration	10	
	enumeration	11	
	enumeration	12	
	enumeration	13	
	enumeration	14	
	enumeration	15	
	enumeration	16	
	enumeration	17	
	enumeration	18	
	enumeration	19	
	enumeration	20	
	enumeration	21	
	enumeration	22	
	enumeration	23	
	enumeration	24	
	enumeration	25	
	enumeration	26	
	enumeration	27	
	enumeration	28	
	enumeration	29	
	enumeration	30	
	enumeration	31	
	enumeration	32	
	enumeration	33	
	enumeration	34	
	enumeration	35	
	enumeration	36	
	enumeration	37	
	enumeration	38	
	enumeration	39	
	enumeration	40	
	enumeration	41	documentation Deprecated: Use code 'E6'
	enumeration	42	documentation

enumeration	43	Deprecated: Use code 'E7' documentation
enumeration	44	Deprecated: Use code 'E9' documentation
enumeration	45	Deprecated: Use code 'EA' documentation
enumeration	46	Deprecated: Use code 'EC' documentation
enumeration	47	Deprecated: Use code 'EB' documentation
enumeration	48	Deprecated: Use code 'EF' documentation
enumeration	49	Deprecated: Use code 'H0' documentation
enumeration	50	Deprecated: Use code 'E8' documentation
enumeration	51	Deprecated: Use code 'H1' documentation
enumeration	52	Deprecated: Use code 'ED' documentation
enumeration	53	Deprecated: Use code 'H2'
enumeration	54	
enumeration	55	
enumeration	56	
enumeration	57	
enumeration	58	
enumeration	59	
enumeration	60	
enumeration	61	
enumeration	62	
enumeration	63	
enumeration	64	
enumeration	65	
enumeration	66	
enumeration	67	
enumeration	68	
enumeration	69	
enumeration	70	
enumeration	71	documentation
enumeration	72	Deprecated: Use code 'E0' documentation
enumeration	73	Deprecated: Use code 'E1' documentation
enumeration	74	Deprecated: Use code 'E2' documentation
enumeration	75	Deprecated: Use code 'E3' documentation
enumeration	76	Deprecated: Use code 'E4' documentation
enumeration	77	Deprecated: Use code 'E5'
enumeration	A0	

enumeration	A1
enumeration	A2
enumeration	A3
enumeration	A4
enumeration	A5
enumeration	A6
enumeration	A7
enumeration	A8
enumeration	A9
enumeration	AA
enumeration	AB
enumeration	AC
enumeration	AD
enumeration	AE
enumeration	AF
enumeration	AG
enumeration	AH
enumeration	AJ
enumeration	AK
enumeration	AL
enumeration	AM
enumeration	AN
enumeration	AP
enumeration	AQ
enumeration	B0
enumeration	B1
enumeration	B2
enumeration	B3
enumeration	B4
enumeration	B5
enumeration	B6
enumeration	B7
enumeration	B8
enumeration	C0
enumeration	C1
enumeration	C2
enumeration	C3
enumeration	C4
enumeration	C5
enumeration	C6
enumeration	C7
enumeration	C8
enumeration	C9
enumeration	CA
enumeration	CB

enumeration	CC	
enumeration	CD	
enumeration	CE	
enumeration	CF	
enumeration	CG	
enumeration	D0	
enumeration	D1	
enumeration	D2	
enumeration	D3	
enumeration	D4	
enumeration	D5	
enumeration	D6	
enumeration	D7	
enumeration	D8	
enumeration	D9	
enumeration	DA	
enumeration	DB	
enumeration	DC	
enumeration	DD	
enumeration	DE	
enumeration	DF	
enumeration	DG	
enumeration	E0	documentation Deprecated: Use code 'EG'
enumeration	E1	documentation Deprecated: Use code 'EG'
enumeration	E2	documentation Deprecated: Use code 'EH'
enumeration	E3	documentation Deprecated: Use code 'EH'
enumeration	E4	
enumeration	E5	
enumeration	E6	
enumeration	E7	
enumeration	E8	
enumeration	E9	
enumeration	EA	
enumeration	EB	
enumeration	EC	
enumeration	ED	
enumeration	EF	
enumeration	EG	
enumeration	EH	
enumeration	EJ	
enumeration	F0	
enumeration	F1	
enumeration	F2	

enumeration	F3
enumeration	F4
enumeration	F5
enumeration	F6
enumeration	F7
enumeration	F8
enumeration	G0
enumeration	G1
enumeration	G2
enumeration	G3
enumeration	G4
enumeration	G5
enumeration	G6
enumeration	G7
enumeration	G8
enumeration	G9
enumeration	GA
enumeration	GB
enumeration	GC
enumeration	GD
enumeration	H0
enumeration	H1
enumeration	H2
enumeration	H3
enumeration	H4
enumeration	H5
enumeration	H6
enumeration	H7
enumeration	H8
enumeration	J0
enumeration	J1
enumeration	J2
enumeration	J3
enumeration	J4
enumeration	JA
enumeration	JB
enumeration	JC
enumeration	JD
enumeration	JE
enumeration	JF
enumeration	JG
enumeration	JH
enumeration	JJ
enumeration	JK
enumeration	JL

	enumeration JM enumeration JN enumeration JP enumeration JQ enumeration JR enumeration JS enumeration K0 enumeration K1 enumeration K2 enumeration K3 enumeration K4 enumeration KA enumeration KB enumeration KC enumeration KD enumeration KE enumeration KF enumeration KG enumeration KH enumeration KJ enumeration KK enumeration KL enumeration KM enumeration KN enumeration KP enumeration KQ enumeration KR enumeration KS
source	<code><xs:element name="TestName" type="trex:TestNameType" minOccurs="0"/></code>

element **AssessmentType/AdditionalTestName**

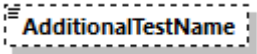
diagram										
type	trex:AdditionalTestNameType									
properties	minOcc 0 maxOcc 1 content simple									
facets	<table border="0"> <tr> <td>Kind</td> <td>Value</td> <td>Annotation</td> </tr> <tr> <td>minLength</td> <td>1</td> <td></td> </tr> <tr> <td>maxLength</td> <td>60</td> <td></td> </tr> </table>	Kind	Value	Annotation	minLength	1		maxLength	60	
Kind	Value	Annotation								
minLength	1									
maxLength	60									
source	<code><xs:element name="AdditionalTestName" type="trex:AdditionalTestNameType" minOccurs="0"/></code>									

element **AssessmentType/TestLevel**

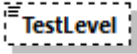
diagram	
type	trex:GradeLevelType
properties	minOcc 0 maxOcc 1 content simple
facets	Kind Value Annotation enumeration EE enumeration PK enumeration KG enumeration 01 enumeration 02 enumeration 03 enumeration 04 enumeration 05 enumeration 06 enumeration 07 enumeration 08 enumeration 09 enumeration 10 enumeration 11 enumeration 12
source	<code><xs:element name="TestLevel" type="trex:GradeLevelType" minOccurs="0"/></code>

element **AssessmentType/TestDate**

diagram	
type	trex:YMType
properties	minOcc 0 maxOcc 1 content simple
facets	Kind Value Annotation pattern [0-9]{4}-[01]?[0-9]
source	<code><xs:element name="TestDate" type="trex:YMType" minOccurs="0"/></code>

element **AssessmentType/ExitRequirementMetDate**

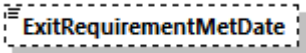
diagram	
type	trex:YMType
properties	minOcc 0 maxOcc 1 content simple

facets	Kind Value Annotation pattern [0-9]{4}-[01]?[0-9]
source	<xs:element name="ExitRequirementMetDate" type="trex:YMType" minOccurs="0"/>

element **AssessmentType/TestScore**

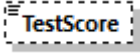
diagram	
type	trex:TestScoreType
properties	minOcc 0 maxOcc 1 content simple
facets	Kind Value Annotation minLength 1 maxLength 6
source	<xs:element name="TestScore" type="trex:TestScoreType" minOccurs="0"/>

element **AssessmentType/TestCode**

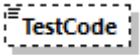
diagram	
type	trex:TestCodeType
properties	minOcc 0 maxOcc 1 content simple
facets	Kind Value Annotation enumeration A enumeration B enumeration C enumeration D enumeration E enumeration G enumeration I enumeration L enumeration M enumeration N enumeration O enumeration P enumeration Q enumeration R enumeration S enumeration T enumeration W enumeration X enumeration Y

	enumeration Z enumeration *
source	<code><xs:element name="TestCode" type="trex:TestCodeType" minOccurs="0"/></code>

element **AssessmentType/PerformanceLevel**

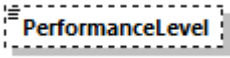
diagram																																					
type	trex:PerformanceLevelType																																				
properties	minOcc 0 maxOcc 1 content simple																																				
facets	<table border="1"> <thead> <tr> <th>Kind</th> <th>Value</th> <th>Annotation</th> </tr> </thead> <tbody> <tr><td>enumeration</td><td>0</td><td></td></tr> <tr><td>enumeration</td><td>1</td><td></td></tr> <tr><td>enumeration</td><td>2</td><td></td></tr> <tr><td>enumeration</td><td>3</td><td></td></tr> <tr><td>enumeration</td><td>4</td><td></td></tr> <tr><td>enumeration</td><td>5</td><td></td></tr> <tr><td>enumeration</td><td>6</td><td></td></tr> <tr><td>enumeration</td><td>7</td><td></td></tr> <tr><td>enumeration</td><td>8</td><td></td></tr> <tr><td>enumeration</td><td>9</td><td></td></tr> <tr><td>enumeration</td><td>A</td><td></td></tr> </tbody> </table>	Kind	Value	Annotation	enumeration	0		enumeration	1		enumeration	2		enumeration	3		enumeration	4		enumeration	5		enumeration	6		enumeration	7		enumeration	8		enumeration	9		enumeration	A	
Kind	Value	Annotation																																			
enumeration	0																																				
enumeration	1																																				
enumeration	2																																				
enumeration	3																																				
enumeration	4																																				
enumeration	5																																				
enumeration	6																																				
enumeration	7																																				
enumeration	8																																				
enumeration	9																																				
enumeration	A																																				
source	<code><xs:element name="PerformanceLevel" type="trex:PerformanceLevelType" minOccurs="0"/></code>																																				

element **AssessmentType/AssessmentSubTest**

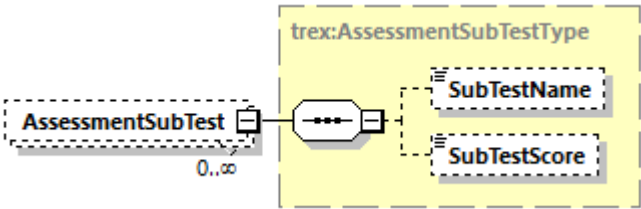
diagram	
type	trex:AssessmentSubTestType
properties	minOcc 0 maxOcc unbounded content complex
children	SubTestName SubTestScore
source	<code><xs:element name="AssessmentSubTest" type="trex:AssessmentSubTestType" minOccurs="0" maxOccurs="unbounded"/></code>

complexType **AttendanceType**

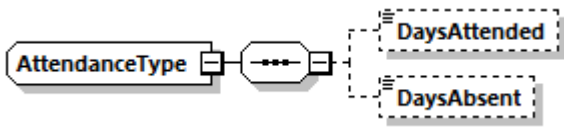
diagram	
namespace	urn:us:tx:state:tea:TREx:v1.16
children	DaysAttended DaysAbsent
used by	element StudentRecordType/Attendance
source	<pre><xs:complexType name="AttendanceType"> <xs:sequence> <xs:element name="DaysAttended" type="trex:DaysType" minOccurs="0"/> <xs:element name="DaysAbsent" type="trex:DaysType" minOccurs="0"/> </xs:sequence> </xs:complexType></pre>

element **AttendanceType/DaysAttended**

diagram										
type	trex:DaysType									
properties	minOcc 0 maxOcc 1 content simple									
facets	<table border="1"> <thead> <tr> <th>Kind</th> <th>Value</th> <th>Annotation</th> </tr> </thead> <tbody> <tr> <td>totalDigits</td> <td>4</td> <td></td> </tr> <tr> <td>fractionDigits</td> <td>1</td> <td></td> </tr> </tbody> </table>	Kind	Value	Annotation	totalDigits	4		fractionDigits	1	
Kind	Value	Annotation								
totalDigits	4									
fractionDigits	1									
source	<pre><xs:element name="DaysAttended" type="trex:DaysType" minOccurs="0"/></pre>									

element **AttendanceType/DaysAbsent**

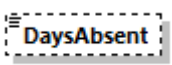
diagram										
type	trex:DaysType									
properties	minOcc 0 maxOcc 1 content simple									
facets	<table border="1"> <thead> <tr> <th>Kind</th> <th>Value</th> <th>Annotation</th> </tr> </thead> <tbody> <tr> <td>totalDigits</td> <td>4</td> <td></td> </tr> <tr> <td>fractionDigits</td> <td>1</td> <td></td> </tr> </tbody> </table>	Kind	Value	Annotation	totalDigits	4		fractionDigits	1	
Kind	Value	Annotation								
totalDigits	4									
fractionDigits	1									
source	<pre><xs:element name="DaysAbsent" type="trex:DaysType" minOccurs="0"/></pre>									

complexType **CourseType**

<p>diagram</p>	
<p>namespace</p>	<p>urn:us:tx:state:tea:TREx:v1.16</p>
<p>children</p>	<p>CourseTitle CourseID Abbreviation Semester ClassPeriod SubjectArea CourseGrade WithdrawGrade GradeAverage CourseCredit PassFailCredit Explanation CourseTeacher CreditCampus SemesterSeq FinalGradeAverage</p>
<p>used by</p>	<p>elements AcademicSessionType/Course CurrentCourseworkType/Course</p>
<p>source</p>	<pre><xs:complexType name="CourseType"> <xs:sequence> <xs:element name="CourseTitle" type="trex:CourseTitleType" minOccurs="0"/> <xs:element name="CourseID" type="trex:CourseIDType" minOccurs="0"/> <xs:element name="Abbreviation" type="trex:AbbreviationType" minOccurs="0"/> <xs:element name="Semester" type="trex:SemesterType" minOccurs="0"/> <xs:element name="ClassPeriod" type="trex:ClassPeriodType" minOccurs="0"/> <xs:element name="SubjectArea" type="trex:SubjectAreaType" minOccurs="0"/> <xs:element name="CourseGrade" type="trex:CourseGradeType" minOccurs="0" maxOccurs="unbounded"/> </pre>

	<pre> <xs:element name="WithdrawGrade" type="trex:WithdrawGradeType" minOccurs="0"/> <xs:element name="GradeAverage" type="trex:CourseGradeType" minOccurs="0"/> <xs:element name="CourseCredit" type="trex:CourseCreditType" minOccurs="0"/> <xs:element name="PassFailCredit" type="trex:PassFailCreditType" minOccurs="0"/> <xs:element name="Explanation" type="trex:CourseExplanationType" minOccurs="0" maxOccurs="unbounded"/> <xs:element name="CourseTeacher" type="trex:CourseTeacherType" minOccurs="0"/> <xs:element name="CreditCampus" type="trex:SchoolIDType" minOccurs="0"/> <xs:element name="SemesterSeq" type="trex:SemesterSeqType" minOccurs="0"/> <xs:element name="FinalGradeAverage" type="trex:CourseGradeType" minOccurs="0"/> </xs:sequence> </xs:complexType> </pre>
--	---

element **CourseType/CourseTitle**

diagram										
type	trex:CourseTitleType									
properties	minOcc 0 maxOcc 1 content simple									
facets	<table border="1"> <thead> <tr> <th>Kind</th> <th>Value</th> <th>Annotation</th> </tr> </thead> <tbody> <tr> <td>minLength</td> <td>1</td> <td></td> </tr> <tr> <td>maxLength</td> <td>100</td> <td></td> </tr> </tbody> </table>	Kind	Value	Annotation	minLength	1		maxLength	100	
Kind	Value	Annotation								
minLength	1									
maxLength	100									
source	<pre><xs:element name="CourseTitle" type="trex:CourseTitleType" minOccurs="0"/></pre>									

element **CourseType/CourseID**

diagram										
type	trex:CourseIDType									
properties	minOcc 0 maxOcc 1 content simple									
facets	<table border="1"> <thead> <tr> <th>Kind</th> <th>Value</th> <th>Annotation</th> </tr> </thead> <tbody> <tr> <td>minLength</td> <td>1</td> <td></td> </tr> <tr> <td>maxLength</td> <td>64</td> <td></td> </tr> </tbody> </table>	Kind	Value	Annotation	minLength	1		maxLength	64	
Kind	Value	Annotation								
minLength	1									
maxLength	64									
source	<pre><xs:element name="CourseID" type="trex:CourseIDType" minOccurs="0"/></pre>									

element **CourseType/Abbreviation**

diagram	
---------	--

type	trex:AbbreviationType
properties	minOcc 0 maxOcc 1 content simple
facets	Kind Value Annotation minLength 1 maxLength 100
source	<code><xs:element name="Abbreviation" type="trex:AbbreviationType" minOccurs="0"/></code>

element **CourseType/Semester**

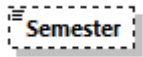
diagram	
type	trex:SemesterType
properties	minOcc 0 maxOcc 1 content simple
facets	Kind Value Annotation totalDigits 1
source	<code><xs:element name="Semester" type="trex:SemesterType" minOccurs="0"/></code>

element **CourseType/ClassPeriod**

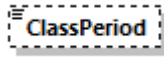
diagram	
type	trex:ClassPeriodType
properties	minOcc 0 maxOcc 1 content simple
facets	Kind Value Annotation minLength 1 maxLength 5
source	<code><xs:element name="ClassPeriod" type="trex:ClassPeriodType" minOccurs="0"/></code>

element **CourseType/SubjectArea**

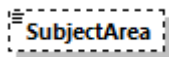
diagram	
type	trex:SubjectAreaType
properties	minOcc 0 maxOcc 1 content simple
facets	Kind Value Annotation enumeration ELA enumeration SP

	enumeration MA enumeration SC enumeration SS enumeration ECFE enumeration HL enumeration PE enumeration LOTE enumeration FA enumeration TA enumeration CTE enumeration EL enumeration LC
source	<code><xs:element name="SubjectArea" type="trex:SubjectAreaType" minOccurs="0"/></code>

element **CourseType/CourseGrade**

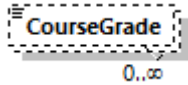
diagram	
type	trex:CourseGradeType
properties	minOcc 0 maxOcc unbounded content simple
facets	Kind Value Annotation minLength 1 maxLength 10
source	<code><xs:element name="CourseGrade" type="trex:CourseGradeType" minOccurs="0" maxOccurs="unbounded"/></code>

element **CourseType/WithdrawGrade**

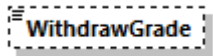
diagram	
type	trex:WithdrawGradeType
properties	minOcc 0 maxOcc 1 content simple
facets	Kind Value Annotation minLength 1 maxLength 15
source	<code><xs:element name="WithdrawGrade" type="trex:WithdrawGradeType" minOccurs="0"/></code>

element **CourseType/GradeAverage**

diagram	
type	trex:CourseGradeType
properties	minOcc 0 maxOcc 1 content simple
facets	Kind Value Annotation minLength 1 maxLength 10
source	<code><xs:element name="GradeAverage" type="trex:CourseGradeType" minOccurs="0"/></code>

element **CourseType/CourseCredit**

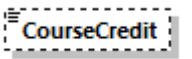
diagram	
type	trex:CourseCreditType
properties	minOcc 0 maxOcc 1 content simple
facets	Kind Value Annotation totalDigits 2 fractionDigits 1
source	<code><xs:element name="CourseCredit" type="trex:CourseCreditType" minOccurs="0"/></code>

element **CourseType/PassFailCredit**

diagram	
type	trex:PassFailCreditType
properties	minOcc 0 maxOcc 1 content simple
facets	Kind Value Annotation enumeration 00 enumeration 01 enumeration 02 enumeration 03 enumeration 04 enumeration 05 enumeration 06 enumeration 07 enumeration 08 enumeration 09 enumeration 10

	enumeration 11 enumeration 12 enumeration 13 enumeration 14
source	<code><xs:element name="PassFailCredit" type="trex:PassFailCreditType" minOccurs="0"/></code>

element **CourseType/Explanation**

diagram																																																																																					
type	trex:CourseExplanationType																																																																																				
properties	minOcc 0 maxOcc unbounded content simple																																																																																				
facets	<table border="1"> <thead> <tr> <th>Kind</th> <th>Value</th> <th>Annotation</th> </tr> </thead> <tbody> <tr><td>enumeration</td><td>A</td><td></td></tr> <tr><td>enumeration</td><td>C</td><td></td></tr> <tr><td>enumeration</td><td>D</td><td></td></tr> <tr><td>enumeration</td><td>E</td><td></td></tr> <tr><td>enumeration</td><td>G</td><td></td></tr> <tr><td>enumeration</td><td>H</td><td></td></tr> <tr><td>enumeration</td><td>I</td><td></td></tr> <tr><td>enumeration</td><td>J</td><td></td></tr> <tr><td>enumeration</td><td>K</td><td></td></tr> <tr><td>enumeration</td><td>L</td><td></td></tr> <tr><td>enumeration</td><td>M</td><td></td></tr> <tr><td>enumeration</td><td>P</td><td></td></tr> <tr><td>enumeration</td><td>Q</td><td></td></tr> <tr><td>enumeration</td><td>R</td><td></td></tr> <tr><td>enumeration</td><td>T</td><td></td></tr> <tr><td>enumeration</td><td>V</td><td></td></tr> <tr><td>enumeration</td><td>X</td><td></td></tr> <tr><td>enumeration</td><td>Z</td><td></td></tr> <tr><td>enumeration</td><td>1</td><td></td></tr> <tr><td>enumeration</td><td>2</td><td></td></tr> <tr><td>enumeration</td><td>3</td><td></td></tr> <tr><td>enumeration</td><td>4</td><td></td></tr> <tr><td>enumeration</td><td>5</td><td></td></tr> <tr><td>enumeration</td><td>7</td><td></td></tr> <tr><td>enumeration</td><td>8</td><td></td></tr> <tr><td>enumeration</td><td>9</td><td></td></tr> <tr><td>enumeration</td><td>10</td><td></td></tr> </tbody> </table>	Kind	Value	Annotation	enumeration	A		enumeration	C		enumeration	D		enumeration	E		enumeration	G		enumeration	H		enumeration	I		enumeration	J		enumeration	K		enumeration	L		enumeration	M		enumeration	P		enumeration	Q		enumeration	R		enumeration	T		enumeration	V		enumeration	X		enumeration	Z		enumeration	1		enumeration	2		enumeration	3		enumeration	4		enumeration	5		enumeration	7		enumeration	8		enumeration	9		enumeration	10	
Kind	Value	Annotation																																																																																			
enumeration	A																																																																																				
enumeration	C																																																																																				
enumeration	D																																																																																				
enumeration	E																																																																																				
enumeration	G																																																																																				
enumeration	H																																																																																				
enumeration	I																																																																																				
enumeration	J																																																																																				
enumeration	K																																																																																				
enumeration	L																																																																																				
enumeration	M																																																																																				
enumeration	P																																																																																				
enumeration	Q																																																																																				
enumeration	R																																																																																				
enumeration	T																																																																																				
enumeration	V																																																																																				
enumeration	X																																																																																				
enumeration	Z																																																																																				
enumeration	1																																																																																				
enumeration	2																																																																																				
enumeration	3																																																																																				
enumeration	4																																																																																				
enumeration	5																																																																																				
enumeration	7																																																																																				
enumeration	8																																																																																				
enumeration	9																																																																																				
enumeration	10																																																																																				
source	<code><xs:element name="Explanation" type="trex:CourseExplanationType" minOccurs="0" maxOccurs="unbounded"/></code>																																																																																				

element **CourseType/CourseTeacher**

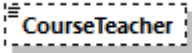
diagram										
type	trex:CourseTeacherType									
properties	minOcc 0 maxOcc 1 content simple									
facets	<table border="1"> <thead> <tr> <th>Kind</th> <th>Value</th> <th>Annotation</th> </tr> </thead> <tbody> <tr> <td>minLength</td> <td>1</td> <td></td> </tr> <tr> <td>maxLength</td> <td>40</td> <td></td> </tr> </tbody> </table>	Kind	Value	Annotation	minLength	1		maxLength	40	
Kind	Value	Annotation								
minLength	1									
maxLength	40									
source	<code><xs:element name="CourseTeacher" type="trex:CourseTeacherType" minOccurs="0"/></code>									

element **CourseType/CreditCampus**

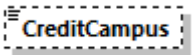
diagram							
type	trex:SchoolIDType						
properties	minOcc 0 maxOcc 1 content simple						
facets	<table border="1"> <thead> <tr> <th>Kind</th> <th>Value</th> <th>Annotation</th> </tr> </thead> <tbody> <tr> <td>pattern</td> <td>([0-9]{9})</td> <td></td> </tr> </tbody> </table>	Kind	Value	Annotation	pattern	([0-9]{9})	
Kind	Value	Annotation					
pattern	([0-9]{9})						
source	<code><xs:element name="CreditCampus" type="trex:SchoolIDType" minOccurs="0"/></code>						

element **CourseType/SemesterSeq**

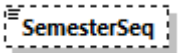
diagram																																		
type	trex:SemesterSeqType																																	
properties	minOcc 0 maxOcc 1 content simple																																	
facets	<table border="1"> <thead> <tr> <th>Kind</th> <th>Value</th> <th>Annotation</th> </tr> </thead> <tbody> <tr><td>enumeration</td><td>0</td><td></td></tr> <tr><td>enumeration</td><td>1</td><td></td></tr> <tr><td>enumeration</td><td>2</td><td></td></tr> <tr><td>enumeration</td><td>3</td><td></td></tr> <tr><td>enumeration</td><td>4</td><td></td></tr> <tr><td>enumeration</td><td>5</td><td></td></tr> <tr><td>enumeration</td><td>6</td><td></td></tr> <tr><td>enumeration</td><td>7</td><td></td></tr> <tr><td>enumeration</td><td>8</td><td></td></tr> <tr><td>enumeration</td><td>9</td><td></td></tr> </tbody> </table>	Kind	Value	Annotation	enumeration	0		enumeration	1		enumeration	2		enumeration	3		enumeration	4		enumeration	5		enumeration	6		enumeration	7		enumeration	8		enumeration	9	
Kind	Value	Annotation																																
enumeration	0																																	
enumeration	1																																	
enumeration	2																																	
enumeration	3																																	
enumeration	4																																	
enumeration	5																																	
enumeration	6																																	
enumeration	7																																	
enumeration	8																																	
enumeration	9																																	

	enumeration A
source	<code><xs:element name="SemesterSeq" type="trex:SemesterSeqType" minOccurs="0"/></code>

element **CourseType/FinalGradeAverage**

diagram	
type	trex:CourseGradeType
properties	minOcc 0 maxOcc 1 content simple
facets	Kind Value Annotation minLength 1 maxLength 10
source	<code><xs:element name="FinalGradeAverage" type="trex:CourseGradeType" minOccurs="0"/></code>

complexType **CurrentCourseworkType**

diagram	
namespace	urn:us:tx:state:tea:TReX:v1.16
children	Course SchoolYear GradeLevel SessionType
used by	element StudentRecordType/CurrentCoursework
source	<pre><xs:complexType name="CurrentCourseworkType"> <xs:sequence> <xs:element name="Course" type="trex:CourseType" maxOccurs="unbounded"/> <xs:element name="SchoolYear" type="trex:YearRangeType"/> <xs:element name="GradeLevel" type="trex:GradeLevelType"/> <xs:element name="SessionType" type="trex:SessionTypeType" minOccurs="0"/> </xs:sequence> </xs:complexType></pre>

element **CurrentCourseworkType/Course**

<p>diagram</p>	<p>The diagram shows the structure of the <code>trex:CourseType</code> element. On the left, a box labeled 'Course' with a multiplicity of <code>1..∞</code> is connected to a container box with a multiplicity of <code>0..∞</code>. This container lists the following child elements: <code>CourseTitle</code>, <code>CourseID</code>, <code>Abbreviation</code>, <code>Semester</code>, <code>ClassPeriod</code>, <code>SubjectArea</code>, <code>CourseGrade</code> (multiplicity <code>0..∞</code>), <code>WithdrawGrade</code>, <code>GradeAverage</code>, <code>CourseCredit</code>, <code>PassFailCredit</code>, <code>Explanation</code> (multiplicity <code>0..∞</code>), <code>CourseTeacher</code>, <code>CreditCampus</code>, <code>SemesterSeq</code>, and <code>FinalGradeAverage</code>.</p>
<p>type</p>	<p>trex:CourseType</p>
<p>properties</p>	<p>minOcc 1 maxOcc unbounded content complex</p>
<p>children</p>	<p>CourseTitle CourseID Abbreviation Semester ClassPeriod SubjectArea CourseGrade WithdrawGrade GradeAverage CourseCredit PassFailCredit Explanation CourseTeacher CreditCampus SemesterSeq FinalGradeAverage</p>
<p>source</p>	<p><code><xs:element name="Course" type="trex:CourseType" maxOccurs="unbounded"/></code></p>

element **CurrentCourseworkType/SchoolYear**

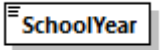
diagram							
type	trex:YearRangeType						
properties	content simple						
facets	<table border="1"> <thead> <tr> <th>Kind</th> <th>Value</th> <th>Annotation</th> </tr> </thead> <tbody> <tr> <td>pattern</td> <td>[0-9]{4}-[0-9]{4}</td> <td></td> </tr> </tbody> </table>	Kind	Value	Annotation	pattern	[0-9]{4}-[0-9]{4}	
Kind	Value	Annotation					
pattern	[0-9]{4}-[0-9]{4}						
source	<code><xs:element name="SchoolYear" type="trex:YearRangeType"/></code>						

element **CurrentCourseworkType/GradeLevel**

diagram																																																	
type	trex:GradeLevelType																																																
properties	content simple																																																
facets	<table border="1"> <thead> <tr> <th>Kind</th> <th>Value</th> <th>Annotation</th> </tr> </thead> <tbody> <tr><td>enumeration</td><td>EE</td><td></td></tr> <tr><td>enumeration</td><td>PK</td><td></td></tr> <tr><td>enumeration</td><td>KG</td><td></td></tr> <tr><td>enumeration</td><td>01</td><td></td></tr> <tr><td>enumeration</td><td>02</td><td></td></tr> <tr><td>enumeration</td><td>03</td><td></td></tr> <tr><td>enumeration</td><td>04</td><td></td></tr> <tr><td>enumeration</td><td>05</td><td></td></tr> <tr><td>enumeration</td><td>06</td><td></td></tr> <tr><td>enumeration</td><td>07</td><td></td></tr> <tr><td>enumeration</td><td>08</td><td></td></tr> <tr><td>enumeration</td><td>09</td><td></td></tr> <tr><td>enumeration</td><td>10</td><td></td></tr> <tr><td>enumeration</td><td>11</td><td></td></tr> <tr><td>enumeration</td><td>12</td><td></td></tr> </tbody> </table>	Kind	Value	Annotation	enumeration	EE		enumeration	PK		enumeration	KG		enumeration	01		enumeration	02		enumeration	03		enumeration	04		enumeration	05		enumeration	06		enumeration	07		enumeration	08		enumeration	09		enumeration	10		enumeration	11		enumeration	12	
Kind	Value	Annotation																																															
enumeration	EE																																																
enumeration	PK																																																
enumeration	KG																																																
enumeration	01																																																
enumeration	02																																																
enumeration	03																																																
enumeration	04																																																
enumeration	05																																																
enumeration	06																																																
enumeration	07																																																
enumeration	08																																																
enumeration	09																																																
enumeration	10																																																
enumeration	11																																																
enumeration	12																																																
source	<code><xs:element name="GradeLevel" type="trex:GradeLevelType"/></code>																																																

element **CurrentCourseworkType/SessionType**

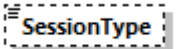
diagram							
type	trex:SessionTypeType						
properties	<table border="1"> <tbody> <tr><td>minOcc</td><td>0</td></tr> <tr><td>maxOcc</td><td>1</td></tr> <tr><td>content</td><td>simple</td></tr> </tbody> </table>	minOcc	0	maxOcc	1	content	simple
minOcc	0						
maxOcc	1						
content	simple						
facets	<table border="1"> <thead> <tr> <th>Kind</th> <th>Value</th> <th>Annotation</th> </tr> </thead> <tbody> <tr> <td>enumeration</td> <td>Semester</td> <td></td> </tr> </tbody> </table>	Kind	Value	Annotation	enumeration	Semester	
Kind	Value	Annotation					
enumeration	Semester						

	enumeration Trimester enumeration Quarter
source	<code><xs:element name="SessionType" type="trex:SessionTypeType" minOccurs="0"/></code>

complexType **DisciplineActionType**

diagram	
namespace	urn:us:tx:state:tea:TREx:v1.16
children	DisciplineActionDate DisciplineActionNum DisciplineActionCode DisciplineActionReason
used by	element StudentRecordType/DisciplineAction
source	<pre> <xs:complexType name="DisciplineActionType"> <xs:sequence> <xs:element name="DisciplineActionDate" type="trex:YMDType" minOccurs="0"/> <xs:element name="DisciplineActionNum" type="trex:DisciplineActionNumType" minOccurs="0"/> <xs:element name="DisciplineActionCode" type="trex:DisciplineActionCodeType" minOccurs="0"/> <xs:element name="DisciplineActionReason" type="trex:DisciplineActionReasonType" minOccurs="0"/> </xs:sequence> </xs:complexType> </pre>

element **DisciplineActionType/DisciplineActionDate**

diagram	
type	trex:YMDType
properties	minOcc 0 maxOcc 1 content simple
facets	Kind Value Annotation pattern [0-9]{4}-[01]?[0-9]-[0123]?[0-9]
source	<code><xs:element name="DisciplineActionDate" type="trex:YMDType" minOccurs="0"/></code>

element **DisciplineActionType/DisciplineActionNum**

diagram	
---------	--

type	trex:DisciplineActionNumType
properties	minOcc 0 maxOcc 1 content simple
facets	Kind Value Annotation totalDigits 3
source	<code><xs:element name="DisciplineActionNum" type="trex:DisciplineActionNumType" minOccurs="0"/></code>

element **DisciplineActionType/DisciplineActionCode**

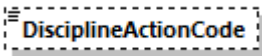
diagram																																																																																								
type	trex:DisciplineActionCodeType																																																																																							
properties	minOcc 0 maxOcc 1 content simple																																																																																							
facets	<table border="1"> <thead> <tr> <th>Kind</th> <th>Value</th> <th>Annotation</th> </tr> </thead> <tbody> <tr><td>enumeration</td><td>01</td><td></td></tr> <tr><td>enumeration</td><td>02</td><td></td></tr> <tr><td>enumeration</td><td>03</td><td></td></tr> <tr><td>enumeration</td><td>04</td><td></td></tr> <tr><td>enumeration</td><td>05</td><td></td></tr> <tr><td>enumeration</td><td>06</td><td></td></tr> <tr><td>enumeration</td><td>07</td><td></td></tr> <tr><td>enumeration</td><td>08</td><td></td></tr> <tr><td>enumeration</td><td>09</td><td></td></tr> <tr><td>enumeration</td><td>10</td><td></td></tr> <tr><td>enumeration</td><td>11</td><td></td></tr> <tr><td>enumeration</td><td>12</td><td></td></tr> <tr><td>enumeration</td><td>13</td><td></td></tr> <tr><td>enumeration</td><td>14</td><td></td></tr> <tr><td>enumeration</td><td>15</td><td></td></tr> <tr><td>enumeration</td><td>25</td><td></td></tr> <tr><td>enumeration</td><td>26</td><td></td></tr> <tr><td>enumeration</td><td>27</td><td></td></tr> <tr><td>enumeration</td><td>28</td><td></td></tr> <tr><td>enumeration</td><td>50</td><td></td></tr> <tr><td>enumeration</td><td>51</td><td></td></tr> <tr><td>enumeration</td><td>52</td><td></td></tr> <tr><td>enumeration</td><td>53</td><td></td></tr> <tr><td>enumeration</td><td>54</td><td></td></tr> <tr><td>enumeration</td><td>55</td><td></td></tr> <tr><td>enumeration</td><td>56</td><td></td></tr> <tr><td>enumeration</td><td>57</td><td></td></tr> <tr><td>enumeration</td><td>58</td><td></td></tr> </tbody> </table>	Kind	Value	Annotation	enumeration	01		enumeration	02		enumeration	03		enumeration	04		enumeration	05		enumeration	06		enumeration	07		enumeration	08		enumeration	09		enumeration	10		enumeration	11		enumeration	12		enumeration	13		enumeration	14		enumeration	15		enumeration	25		enumeration	26		enumeration	27		enumeration	28		enumeration	50		enumeration	51		enumeration	52		enumeration	53		enumeration	54		enumeration	55		enumeration	56		enumeration	57		enumeration	58	
Kind	Value	Annotation																																																																																						
enumeration	01																																																																																							
enumeration	02																																																																																							
enumeration	03																																																																																							
enumeration	04																																																																																							
enumeration	05																																																																																							
enumeration	06																																																																																							
enumeration	07																																																																																							
enumeration	08																																																																																							
enumeration	09																																																																																							
enumeration	10																																																																																							
enumeration	11																																																																																							
enumeration	12																																																																																							
enumeration	13																																																																																							
enumeration	14																																																																																							
enumeration	15																																																																																							
enumeration	25																																																																																							
enumeration	26																																																																																							
enumeration	27																																																																																							
enumeration	28																																																																																							
enumeration	50																																																																																							
enumeration	51																																																																																							
enumeration	52																																																																																							
enumeration	53																																																																																							
enumeration	54																																																																																							
enumeration	55																																																																																							
enumeration	56																																																																																							
enumeration	57																																																																																							
enumeration	58																																																																																							

	enumeration 59 enumeration 60 enumeration 61
source	<code><xs:element name="DisciplineActionCode" type="trex:DisciplineActionCodeType" minOccurs="0"/></code>

element **DisciplineActionType/DisciplineActionReason**

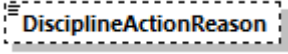
diagram																																																																																														
type	trex:DisciplineActionReasonType																																																																																													
properties	minOcc 0 maxOcc 1 content simple																																																																																													
facets	<table border="1"> <thead> <tr> <th>Kind</th> <th>Value</th> <th>Annotation</th> </tr> </thead> <tbody> <tr><td>enumeration</td><td>01</td><td></td></tr> <tr><td>enumeration</td><td>02</td><td></td></tr> <tr><td>enumeration</td><td>04</td><td></td></tr> <tr><td>enumeration</td><td>05</td><td></td></tr> <tr><td>enumeration</td><td>06</td><td></td></tr> <tr><td>enumeration</td><td>07</td><td></td></tr> <tr><td>enumeration</td><td>08</td><td></td></tr> <tr><td>enumeration</td><td>09</td><td></td></tr> <tr><td>enumeration</td><td>10</td><td></td></tr> <tr><td>enumeration</td><td>11</td><td></td></tr> <tr><td>enumeration</td><td>12</td><td></td></tr> <tr><td>enumeration</td><td>13</td><td></td></tr> <tr><td>enumeration</td><td>14</td><td></td></tr> <tr><td>enumeration</td><td>16</td><td></td></tr> <tr><td>enumeration</td><td>17</td><td></td></tr> <tr><td>enumeration</td><td>18</td><td></td></tr> <tr><td>enumeration</td><td>19</td><td></td></tr> <tr><td>enumeration</td><td>20</td><td></td></tr> <tr><td>enumeration</td><td>21</td><td></td></tr> <tr><td>enumeration</td><td>22</td><td></td></tr> <tr><td>enumeration</td><td>23</td><td></td></tr> <tr><td>enumeration</td><td>26</td><td></td></tr> <tr><td>enumeration</td><td>27</td><td></td></tr> <tr><td>enumeration</td><td>28</td><td></td></tr> <tr><td>enumeration</td><td>29</td><td></td></tr> <tr><td>enumeration</td><td>30</td><td></td></tr> <tr><td>enumeration</td><td>31</td><td></td></tr> <tr><td>enumeration</td><td>32</td><td></td></tr> <tr><td>enumeration</td><td>33</td><td></td></tr> <tr><td>enumeration</td><td>34</td><td></td></tr> </tbody> </table>	Kind	Value	Annotation	enumeration	01		enumeration	02		enumeration	04		enumeration	05		enumeration	06		enumeration	07		enumeration	08		enumeration	09		enumeration	10		enumeration	11		enumeration	12		enumeration	13		enumeration	14		enumeration	16		enumeration	17		enumeration	18		enumeration	19		enumeration	20		enumeration	21		enumeration	22		enumeration	23		enumeration	26		enumeration	27		enumeration	28		enumeration	29		enumeration	30		enumeration	31		enumeration	32		enumeration	33		enumeration	34	
Kind	Value	Annotation																																																																																												
enumeration	01																																																																																													
enumeration	02																																																																																													
enumeration	04																																																																																													
enumeration	05																																																																																													
enumeration	06																																																																																													
enumeration	07																																																																																													
enumeration	08																																																																																													
enumeration	09																																																																																													
enumeration	10																																																																																													
enumeration	11																																																																																													
enumeration	12																																																																																													
enumeration	13																																																																																													
enumeration	14																																																																																													
enumeration	16																																																																																													
enumeration	17																																																																																													
enumeration	18																																																																																													
enumeration	19																																																																																													
enumeration	20																																																																																													
enumeration	21																																																																																													
enumeration	22																																																																																													
enumeration	23																																																																																													
enumeration	26																																																																																													
enumeration	27																																																																																													
enumeration	28																																																																																													
enumeration	29																																																																																													
enumeration	30																																																																																													
enumeration	31																																																																																													
enumeration	32																																																																																													
enumeration	33																																																																																													
enumeration	34																																																																																													

	enumeration 35	
	enumeration 36	
	enumeration 37	
	enumeration 41	
	enumeration 46	
	enumeration 47	
	enumeration 48	
	enumeration 49	
	enumeration 50	documentation Deprecated
	enumeration 51	
	enumeration 52	
	enumeration 53	
	enumeration 54	
	enumeration 55	
	enumeration 56	
	enumeration 57	
	enumeration 58	
	enumeration 59	
source	<code><xs:element name="DisciplineActionReason" type="trex:DisciplineActionReasonType" minOccurs="0"/></code>	

complexType **DistinguishedAchievementType**

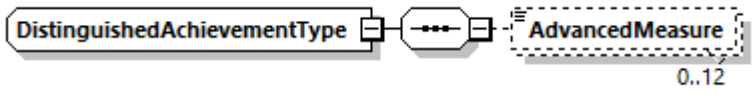
diagram	
namespace	urn:us:tx:state:tea:TREx:v1.16
children	AdvancedMeasure
used by	element AcademicStatusType/DistinguishedAchievements
source	<code><xs:complexType name="DistinguishedAchievementType"> <xs:sequence> <xs:element name="AdvancedMeasure" type="trex:AdvancedMeasureType" minOccurs="0" maxOccurs="12"/> </xs:sequence> </xs:complexType></code>

element **DistinguishedAchievementType/AdvancedMeasure**

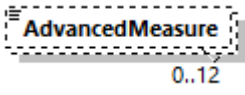
diagram	
type	trex:AdvancedMeasureType
properties	minOcc 0 maxOcc 12

	content	simple
facets	Kind	Value Annotation
	enumeration	A
	enumeration	B
	enumeration	C
	enumeration	D
	enumeration	E
	enumeration	F
source	<pre><xs:element name="AdvancedMeasure" type="trex:AdvancedMeasureType" minOccurs="0" maxOccurs="12"/></pre>	

complexType **EnrollmentType**

diagram	
namespace	urn:us:tx:state:tea:TREx:v1.16
children	GradeLevel EntryDate ExitDate WithdrawDate WithdrawReason GradePlaced GradePromoted GradeRetained
used by	element StudentRecordType/Enrollment
source	<pre><xs:complexType name="EnrollmentType"> <xs:sequence> <xs:element name="GradeLevel" type="trex:GradeLevelType" minOccurs="0"/> <xs:element name="EntryDate" type="trex:YMDType" minOccurs="0"/> <xs:element name="ExitDate" type="trex:YMDType" minOccurs="0"/> <xs:element name="WithdrawDate" type="trex:YMDType" minOccurs="0"/> <xs:element name="WithdrawReason" type="trex:WithdrawReasonType" minOccurs="0"/> <xs:element name="GradePlaced" type="trex:GradeLevelType" minOccurs="0"/> <xs:element name="GradePromoted" type="trex:GradeLevelType" minOccurs="0"/> <xs:element name="GradeRetained" type="trex:GradeLevelType" minOccurs="0"/> </xs:sequence> </xs:complexType></pre>

element **EnrollmentType/GradeLevel**

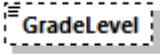
diagram																																																	
type	trex:GradeLevelType																																																
properties	minOcc 0 maxOcc 1 content simple																																																
facets	<table border="0"> <tr> <td>Kind</td> <td>Value</td> <td>Annotation</td> </tr> <tr> <td>enumeration</td> <td>EE</td> <td></td> </tr> <tr> <td>enumeration</td> <td>PK</td> <td></td> </tr> <tr> <td>enumeration</td> <td>KG</td> <td></td> </tr> <tr> <td>enumeration</td> <td>01</td> <td></td> </tr> <tr> <td>enumeration</td> <td>02</td> <td></td> </tr> <tr> <td>enumeration</td> <td>03</td> <td></td> </tr> <tr> <td>enumeration</td> <td>04</td> <td></td> </tr> <tr> <td>enumeration</td> <td>05</td> <td></td> </tr> <tr> <td>enumeration</td> <td>06</td> <td></td> </tr> <tr> <td>enumeration</td> <td>07</td> <td></td> </tr> <tr> <td>enumeration</td> <td>08</td> <td></td> </tr> <tr> <td>enumeration</td> <td>09</td> <td></td> </tr> <tr> <td>enumeration</td> <td>10</td> <td></td> </tr> <tr> <td>enumeration</td> <td>11</td> <td></td> </tr> <tr> <td>enumeration</td> <td>12</td> <td></td> </tr> </table>	Kind	Value	Annotation	enumeration	EE		enumeration	PK		enumeration	KG		enumeration	01		enumeration	02		enumeration	03		enumeration	04		enumeration	05		enumeration	06		enumeration	07		enumeration	08		enumeration	09		enumeration	10		enumeration	11		enumeration	12	
Kind	Value	Annotation																																															
enumeration	EE																																																
enumeration	PK																																																
enumeration	KG																																																
enumeration	01																																																
enumeration	02																																																
enumeration	03																																																
enumeration	04																																																
enumeration	05																																																
enumeration	06																																																
enumeration	07																																																
enumeration	08																																																
enumeration	09																																																
enumeration	10																																																
enumeration	11																																																
enumeration	12																																																
source	<code><xs:element name="GradeLevel" type="trex:GradeLevelType" minOccurs="0"/></code>																																																

element **EnrollmentType/EntryDate**

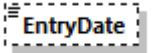
diagram							
type	trex:YMDType						
properties	minOcc 0 maxOcc 1 content simple						
facets	<table border="0"> <tr> <td>Kind</td> <td>Value</td> <td>Annotation</td> </tr> <tr> <td>pattern</td> <td>[0-9]{4}-[01]?[0-9]-[0123]?[0-9]</td> <td></td> </tr> </table>	Kind	Value	Annotation	pattern	[0-9]{4}-[01]?[0-9]-[0123]?[0-9]	
Kind	Value	Annotation					
pattern	[0-9]{4}-[01]?[0-9]-[0123]?[0-9]						
source	<code><xs:element name="EntryDate" type="trex:YMDType" minOccurs="0"/></code>						

element **EnrollmentType/ExitDate**

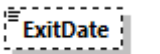
diagram	
type	trex:YMDType
properties	minOcc 0 maxOcc 1 content simple

facets	Kind Value Annotation pattern [0-9]{4}-[01]?[0-9]-[0123]?[0-9]
source	<xs:element name="ExitDate" type="trex:YMDType" minOccurs="0"/>

element **EnrollmentType/WithdrawDate**

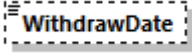
diagram	
type	trex:YMDType
properties	minOcc 0 maxOcc 1 content simple
facets	Kind Value Annotation pattern [0-9]{4}-[01]?[0-9]-[0123]?[0-9]
source	<xs:element name="WithdrawDate" type="trex:YMDType" minOccurs="0"/>

element **EnrollmentType/WithdrawReason**

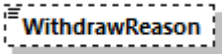
diagram																																																										
type	trex:WithdrawReasonType																																																									
properties	minOcc 0 maxOcc 1 content simple																																																									
facets	<table border="1"> <thead> <tr> <th>Kind</th> <th>Value</th> <th>Annotation</th> </tr> </thead> <tbody> <tr><td>enumeration</td><td>01</td><td></td></tr> <tr><td>enumeration</td><td>03</td><td></td></tr> <tr><td>enumeration</td><td>16</td><td></td></tr> <tr><td>enumeration</td><td>24</td><td></td></tr> <tr><td>enumeration</td><td>60</td><td></td></tr> <tr><td>enumeration</td><td>66</td><td></td></tr> <tr><td>enumeration</td><td>78</td><td></td></tr> <tr><td>enumeration</td><td>81</td><td></td></tr> <tr><td>enumeration</td><td>82</td><td></td></tr> <tr><td>enumeration</td><td>83</td><td></td></tr> <tr><td>enumeration</td><td>85</td><td></td></tr> <tr><td>enumeration</td><td>86</td><td></td></tr> <tr><td>enumeration</td><td>87</td><td></td></tr> <tr><td>enumeration</td><td>88</td><td></td></tr> <tr><td>enumeration</td><td>89</td><td></td></tr> <tr><td>enumeration</td><td>90</td><td></td></tr> <tr><td>enumeration</td><td>98</td><td></td></tr> <tr><td>enumeration</td><td>99</td><td></td></tr> </tbody> </table>	Kind	Value	Annotation	enumeration	01		enumeration	03		enumeration	16		enumeration	24		enumeration	60		enumeration	66		enumeration	78		enumeration	81		enumeration	82		enumeration	83		enumeration	85		enumeration	86		enumeration	87		enumeration	88		enumeration	89		enumeration	90		enumeration	98		enumeration	99	
Kind	Value	Annotation																																																								
enumeration	01																																																									
enumeration	03																																																									
enumeration	16																																																									
enumeration	24																																																									
enumeration	60																																																									
enumeration	66																																																									
enumeration	78																																																									
enumeration	81																																																									
enumeration	82																																																									
enumeration	83																																																									
enumeration	85																																																									
enumeration	86																																																									
enumeration	87																																																									
enumeration	88																																																									
enumeration	89																																																									
enumeration	90																																																									
enumeration	98																																																									
enumeration	99																																																									
source	<xs:element name="WithdrawReason" type="trex:WithdrawReasonType" minOccurs="0"/>																																																									

element **EnrollmentType/GradePlaced**

diagram																																																	
type	trex:GradeLevelType																																																
properties	minOcc 0 maxOcc 1 content simple																																																
facets	<table border="1"> <thead> <tr> <th>Kind</th> <th>Value</th> <th>Annotation</th> </tr> </thead> <tbody> <tr><td>enumeration</td><td>EE</td><td></td></tr> <tr><td>enumeration</td><td>PK</td><td></td></tr> <tr><td>enumeration</td><td>KG</td><td></td></tr> <tr><td>enumeration</td><td>01</td><td></td></tr> <tr><td>enumeration</td><td>02</td><td></td></tr> <tr><td>enumeration</td><td>03</td><td></td></tr> <tr><td>enumeration</td><td>04</td><td></td></tr> <tr><td>enumeration</td><td>05</td><td></td></tr> <tr><td>enumeration</td><td>06</td><td></td></tr> <tr><td>enumeration</td><td>07</td><td></td></tr> <tr><td>enumeration</td><td>08</td><td></td></tr> <tr><td>enumeration</td><td>09</td><td></td></tr> <tr><td>enumeration</td><td>10</td><td></td></tr> <tr><td>enumeration</td><td>11</td><td></td></tr> <tr><td>enumeration</td><td>12</td><td></td></tr> </tbody> </table>	Kind	Value	Annotation	enumeration	EE		enumeration	PK		enumeration	KG		enumeration	01		enumeration	02		enumeration	03		enumeration	04		enumeration	05		enumeration	06		enumeration	07		enumeration	08		enumeration	09		enumeration	10		enumeration	11		enumeration	12	
Kind	Value	Annotation																																															
enumeration	EE																																																
enumeration	PK																																																
enumeration	KG																																																
enumeration	01																																																
enumeration	02																																																
enumeration	03																																																
enumeration	04																																																
enumeration	05																																																
enumeration	06																																																
enumeration	07																																																
enumeration	08																																																
enumeration	09																																																
enumeration	10																																																
enumeration	11																																																
enumeration	12																																																
source	<code><xs:element name="GradePlaced" type="trex:GradeLevelType" minOccurs="0"/></code>																																																

element **EnrollmentType/GradePromoted**

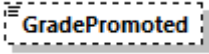
diagram																																		
type	trex:GradeLevelType																																	
properties	minOcc 0 maxOcc 1 content simple																																	
facets	<table border="1"> <thead> <tr> <th>Kind</th> <th>Value</th> <th>Annotation</th> </tr> </thead> <tbody> <tr><td>enumeration</td><td>EE</td><td></td></tr> <tr><td>enumeration</td><td>PK</td><td></td></tr> <tr><td>enumeration</td><td>KG</td><td></td></tr> <tr><td>enumeration</td><td>01</td><td></td></tr> <tr><td>enumeration</td><td>02</td><td></td></tr> <tr><td>enumeration</td><td>03</td><td></td></tr> <tr><td>enumeration</td><td>04</td><td></td></tr> <tr><td>enumeration</td><td>05</td><td></td></tr> <tr><td>enumeration</td><td>06</td><td></td></tr> <tr><td>enumeration</td><td>07</td><td></td></tr> </tbody> </table>	Kind	Value	Annotation	enumeration	EE		enumeration	PK		enumeration	KG		enumeration	01		enumeration	02		enumeration	03		enumeration	04		enumeration	05		enumeration	06		enumeration	07	
Kind	Value	Annotation																																
enumeration	EE																																	
enumeration	PK																																	
enumeration	KG																																	
enumeration	01																																	
enumeration	02																																	
enumeration	03																																	
enumeration	04																																	
enumeration	05																																	
enumeration	06																																	
enumeration	07																																	

	enumeration 08 enumeration 09 enumeration 10 enumeration 11 enumeration 12
source	<code><xs:element name="GradePromoted" type="trex:GradeLevelType" minOccurs="0"/></code>

element **EnrollmentType/GradeRetained**

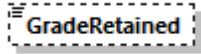
diagram																																																	
type	trex:GradeLevelType																																																
properties	minOcc 0 maxOcc 1 content simple																																																
facets	<table border="1"> <thead> <tr> <th>Kind</th> <th>Value</th> <th>Annotation</th> </tr> </thead> <tbody> <tr><td>enumeration</td><td>EE</td><td></td></tr> <tr><td>enumeration</td><td>PK</td><td></td></tr> <tr><td>enumeration</td><td>KG</td><td></td></tr> <tr><td>enumeration</td><td>01</td><td></td></tr> <tr><td>enumeration</td><td>02</td><td></td></tr> <tr><td>enumeration</td><td>03</td><td></td></tr> <tr><td>enumeration</td><td>04</td><td></td></tr> <tr><td>enumeration</td><td>05</td><td></td></tr> <tr><td>enumeration</td><td>06</td><td></td></tr> <tr><td>enumeration</td><td>07</td><td></td></tr> <tr><td>enumeration</td><td>08</td><td></td></tr> <tr><td>enumeration</td><td>09</td><td></td></tr> <tr><td>enumeration</td><td>10</td><td></td></tr> <tr><td>enumeration</td><td>11</td><td></td></tr> <tr><td>enumeration</td><td>12</td><td></td></tr> </tbody> </table>	Kind	Value	Annotation	enumeration	EE		enumeration	PK		enumeration	KG		enumeration	01		enumeration	02		enumeration	03		enumeration	04		enumeration	05		enumeration	06		enumeration	07		enumeration	08		enumeration	09		enumeration	10		enumeration	11		enumeration	12	
Kind	Value	Annotation																																															
enumeration	EE																																																
enumeration	PK																																																
enumeration	KG																																																
enumeration	01																																																
enumeration	02																																																
enumeration	03																																																
enumeration	04																																																
enumeration	05																																																
enumeration	06																																																
enumeration	07																																																
enumeration	08																																																
enumeration	09																																																
enumeration	10																																																
enumeration	11																																																
enumeration	12																																																
source	<code><xs:element name="GradeRetained" type="trex:GradeLevelType" minOccurs="0"/></code>																																																

complexType **EthnicityType**

diagram	
namespace	urn:us:tx:state:tea:TREx:v1.16
children	AmericanIndianAlaskaNativeCode AsianCode BlackAfricanAmericanCode HispanicLatinoCode NativeHawaiianPacificIslanderCode WhiteCode
used by	element StudentDemographicType/Ethnicity
source	<pre><xs:complexType name="EthnicityType"> <xs:sequence> <xs:element name="AmericanIndianAlaskaNativeCode" type="trex:EthnicityYesNoType"/> <xs:element name="AsianCode" type="trex:EthnicityYesNoType"/> <xs:element name="BlackAfricanAmericanCode" type="trex:EthnicityYesNoType"/> <xs:element name="HispanicLatinoCode" type="trex:EthnicityYesNoType"/> <xs:element name="NativeHawaiianPacificIslanderCode" type="trex:EthnicityYesNoType"/> <xs:element name="WhiteCode" type="trex:EthnicityYesNoType"/> </xs:sequence> </xs:complexType></pre>

element **EthnicityType/AmericanIndianAlaskaNativeCode**

diagram										
type	trex:EthnicityYesNoType									
properties	content simple									
facets	<table border="1"> <thead> <tr> <th>Kind</th> <th>Value</th> <th>Annotation</th> </tr> </thead> <tbody> <tr> <td>enumeration</td> <td>0</td> <td></td> </tr> <tr> <td>enumeration</td> <td>1</td> <td></td> </tr> </tbody> </table>	Kind	Value	Annotation	enumeration	0		enumeration	1	
Kind	Value	Annotation								
enumeration	0									
enumeration	1									
source	<pre><xs:element name="AmericanIndianAlaskaNativeCode" type="trex:EthnicityYesNoType"/></pre>									

element **EthnicityType/AsianCode**

diagram	
---------	--

type	trex:EthnicityYesNoType									
properties	content simple									
facets	<table border="1"> <thead> <tr> <th>Kind</th> <th>Value</th> <th>Annotation</th> </tr> </thead> <tbody> <tr> <td>enumeration</td> <td>0</td> <td></td> </tr> <tr> <td>enumeration</td> <td>1</td> <td></td> </tr> </tbody> </table>	Kind	Value	Annotation	enumeration	0		enumeration	1	
Kind	Value	Annotation								
enumeration	0									
enumeration	1									
source	<code><xs:element name="AsianCode" type="trex:EthnicityYesNoType"/></code>									

element **EthnicityType/BlackAfricanAmericanCode**

diagram										
type	trex:EthnicityYesNoType									
properties	content simple									
facets	<table border="1"> <thead> <tr> <th>Kind</th> <th>Value</th> <th>Annotation</th> </tr> </thead> <tbody> <tr> <td>enumeration</td> <td>0</td> <td></td> </tr> <tr> <td>enumeration</td> <td>1</td> <td></td> </tr> </tbody> </table>	Kind	Value	Annotation	enumeration	0		enumeration	1	
Kind	Value	Annotation								
enumeration	0									
enumeration	1									
source	<code><xs:element name="BlackAfricanAmericanCode" type="trex:EthnicityYesNoType"/></code>									

element **EthnicityType/HispanicLatinoCode**

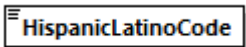
diagram										
type	trex:EthnicityYesNoType									
properties	content simple									
facets	<table border="1"> <thead> <tr> <th>Kind</th> <th>Value</th> <th>Annotation</th> </tr> </thead> <tbody> <tr> <td>enumeration</td> <td>0</td> <td></td> </tr> <tr> <td>enumeration</td> <td>1</td> <td></td> </tr> </tbody> </table>	Kind	Value	Annotation	enumeration	0		enumeration	1	
Kind	Value	Annotation								
enumeration	0									
enumeration	1									
source	<code><xs:element name="HispanicLatinoCode" type="trex:EthnicityYesNoType"/></code>									

element **EthnicityType/NativeHawaiianPacificIslanderCode**

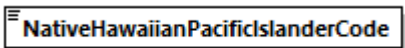
diagram										
type	trex:EthnicityYesNoType									
properties	content simple									
facets	<table border="1"> <thead> <tr> <th>Kind</th> <th>Value</th> <th>Annotation</th> </tr> </thead> <tbody> <tr> <td>enumeration</td> <td>0</td> <td></td> </tr> <tr> <td>enumeration</td> <td>1</td> <td></td> </tr> </tbody> </table>	Kind	Value	Annotation	enumeration	0		enumeration	1	
Kind	Value	Annotation								
enumeration	0									
enumeration	1									
source	<code><xs:element name="NativeHawaiianPacificIslanderCode" type="trex:EthnicityYesNoType"/></code>									

element **EthnicityType/WhiteCode**

diagram										
type	trex:EthnicityYesNoType									
properties	content simple									
facets	<table border="1"> <thead> <tr> <th>Kind</th> <th>Value</th> <th>Annotation</th> </tr> </thead> <tbody> <tr> <td>enumeration</td> <td>0</td> <td></td> </tr> <tr> <td>enumeration</td> <td>1</td> <td></td> </tr> </tbody> </table>	Kind	Value	Annotation	enumeration	0		enumeration	1	
Kind	Value	Annotation								
enumeration	0									
enumeration	1									
source	<code><xs:element name="WhiteCode" type="trex:EthnicityYesNoType"/></code>									

complexType **ImmunizationType**

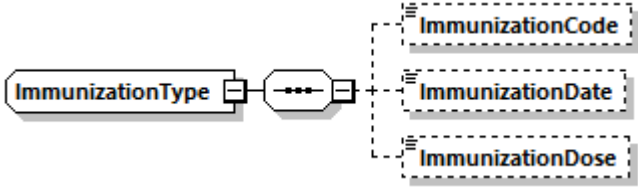
diagram	
namespace	urn:us:tx:state:tea:TREx:v1.16
children	ImmunizationCode ImmunizationDate ImmunizationDose
used by	element StudentRecordType/Immunization
source	<pre><xs:complexType name="ImmunizationType"> <xs:sequence> <xs:element name="ImmunizationCode" type="trex:ImmunizationCodeType" minOccurs="0"/> <xs:element name="ImmunizationDate" type="trex:YMDType" minOccurs="0"/> <xs:element name="ImmunizationDose" type="trex:ImmunizationDoseType" minOccurs="0"/> </xs:sequence> </xs:complexType></pre>

element **ImmunizationType/ImmunizationCode**

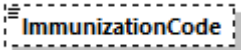
diagram										
type	trex:ImmunizationCodeType									
properties	minOcc 0 maxOcc 1 content simple									
facets	<table border="1"> <thead> <tr> <th>Kind</th> <th>Value</th> <th>Annotation</th> </tr> </thead> <tbody> <tr> <td>minLength</td> <td>1</td> <td></td> </tr> <tr> <td>maxLength</td> <td>35</td> <td></td> </tr> </tbody> </table>	Kind	Value	Annotation	minLength	1		maxLength	35	
Kind	Value	Annotation								
minLength	1									
maxLength	35									
source	<code><xs:element name="ImmunizationCode" type="trex:ImmunizationCodeType"</code>									

	<code>minOccurs="0"/></code>
--	---------------------------------

element **ImmunizationType/ImmunizationDate**

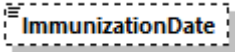
diagram	
type	trex:YMDType
properties	minOcc 0 maxOcc 1 content simple
facets	Kind Value Annotation pattern [0-9]{4}-[01]?[0-9]-[0123]?[0-9]
source	<code><xs:element name="ImmunizationDate" type="trex:YMDType" minOccurs="0"/></code>

element **ImmunizationType/ImmunizationDose**

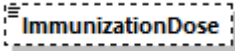
diagram	
type	trex:ImmunizationDoseType
properties	minOcc 0 maxOcc 1 content simple
facets	Kind Value Annotation totalDigits 2
source	<code><xs:element name="ImmunizationDose" type="trex:ImmunizationDoseType" minOccurs="0"/></code>

complexType **ParentType**

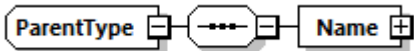
diagram	
namespace	urn:us:tx:state:tea:TREx:v1.16
children	Name
used by	element StudentRecordType/Parent
source	<code><xs:complexType name="ParentType"> <xs:sequence> <xs:element name="Name" type="trex:PersonNameType"/> </xs:sequence> </xs:complexType></code>

element **ParentType/Name**

diagram	
type	trex:PersonNameType
properties	content complex
children	FirstName MiddleName LastName Suffix
source	<code><xs:element name="Name" type="trex:PersonNameType"/></code>

complexType **PerfAckApIbType**

diagram	
namespace	urn:us:tx:state:tea:TREx:v1.16
children	ApIbCode MetDate
used by	element AcademicStatusType/ApIbType
source	<pre><xs:complexType name="PerfAckApIbType"> <xs:sequence> <xs:element name="ApIbCode" type="trex:PerfAckApIbCode"/> <xs:element name="MetDate" type="trex:YMTType"/> </xs:sequence> </xs:complexType></pre>

element **PerfAckApIbType/ApIbCode**

diagram																
type	trex:PerfAckApIbCode															
properties	content simple															
facets	<table border="1"> <thead> <tr> <th>Kind</th> <th>Value</th> <th>Annotation</th> </tr> </thead> <tbody> <tr> <td>enumeration</td> <td>0</td> <td></td> </tr> <tr> <td>enumeration</td> <td>1</td> <td></td> </tr> <tr> <td>enumeration</td> <td>2</td> <td></td> </tr> <tr> <td>enumeration</td> <td>3</td> <td></td> </tr> </tbody> </table>	Kind	Value	Annotation	enumeration	0		enumeration	1		enumeration	2		enumeration	3	
Kind	Value	Annotation														
enumeration	0															
enumeration	1															
enumeration	2															
enumeration	3															

enumeration	4
enumeration	5
enumeration	6
enumeration	7
enumeration	8
enumeration	9
enumeration	10
enumeration	11
enumeration	12
enumeration	13
enumeration	14
enumeration	15
enumeration	16
enumeration	17
enumeration	18
enumeration	19
enumeration	20
enumeration	21
enumeration	22
enumeration	23
enumeration	24
enumeration	25
enumeration	26
enumeration	27
enumeration	28
enumeration	29
enumeration	30
enumeration	31
enumeration	32
enumeration	33
enumeration	34
enumeration	35
enumeration	36
enumeration	37
enumeration	38
enumeration	39
enumeration	40
enumeration	41
enumeration	42
enumeration	43
enumeration	44
enumeration	45
enumeration	46
enumeration	47
enumeration	48

enumeration	49
enumeration	50
enumeration	51
enumeration	52
enumeration	53
enumeration	54
enumeration	55
enumeration	56
enumeration	57
enumeration	58
enumeration	59
enumeration	60
enumeration	61
enumeration	62
enumeration	63
enumeration	64
enumeration	65
enumeration	66
enumeration	67
enumeration	68
enumeration	69
enumeration	70
enumeration	71
enumeration	72
enumeration	73
enumeration	74
enumeration	75
enumeration	76
enumeration	77
enumeration	78
enumeration	79
enumeration	80
enumeration	81
enumeration	82
enumeration	83
enumeration	84
enumeration	85
enumeration	86
enumeration	87
enumeration	88
enumeration	89
enumeration	90
enumeration	91
enumeration	92
enumeration	93

	enumeration 94
	enumeration 95
	enumeration 96
	enumeration 97
	enumeration 98
	enumeration 99
	enumeration 100
	enumeration 101
	enumeration 102
	enumeration 103
	enumeration 104
	enumeration 105
	enumeration 106
	enumeration 107
	enumeration 108
	enumeration 109
	enumeration 110
	enumeration 111
	enumeration 112
	enumeration 113
	enumeration 114
	enumeration 115
	enumeration 116
	enumeration 117
	enumeration 118
	enumeration 119
	enumeration 120
	enumeration 121
	enumeration 122
	enumeration 123
	enumeration 124
	enumeration 125
	enumeration 126
	enumeration 127
	enumeration 128
	enumeration 129
	enumeration 150
source	<code><xs:element name="ApIbCode" type="trex:PerfAckApIbCode"/></code>

element **PerfAckApIbType/MetDate**

diagram	
type	trex:YMType

properties	content simple						
facets	<table border="1"> <thead> <tr> <th>Kind</th> <th>Value</th> <th>Annotation</th> </tr> </thead> <tbody> <tr> <td>pattern</td> <td>[0-9]{4}-[01]?[0-9]</td> <td></td> </tr> </tbody> </table>	Kind	Value	Annotation	pattern	[0-9]{4}-[01]?[0-9]	
Kind	Value	Annotation					
pattern	[0-9]{4}-[01]?[0-9]						
source	<code><xs:element name="MetDate" type="trex:YMType"/></code>						

complexType **PerfAckBilingBilitType**

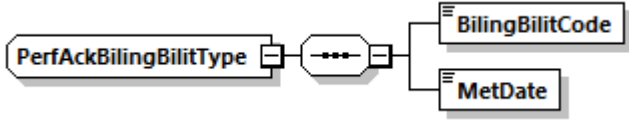
diagram	
namespace	urn:us:tx:state:tea:TREx:v1.16
children	BilingBilitCode MetDate
used by	element AcademicStatusType/BilingBilitType
source	<pre><xs:complexType name="PerfAckBilingBilitType"> <xs:sequence> <xs:element name="BilingBilitCode" type="trex:PerfAckBilingBilitCode"/> <xs:element name="MetDate" type="trex:YMType"/> </xs:sequence> </xs:complexType></pre>

element **PerfAckBilingBilitType/BilingBilitCode**

diagram										
type	trex:PerfAckBilingBilitCode									
properties	content simple									
facets	<table border="1"> <thead> <tr> <th>Kind</th> <th>Value</th> <th>Annotation</th> </tr> </thead> <tbody> <tr> <td>enumeration</td> <td>0</td> <td></td> </tr> <tr> <td>enumeration</td> <td>1</td> <td></td> </tr> </tbody> </table>	Kind	Value	Annotation	enumeration	0		enumeration	1	
Kind	Value	Annotation								
enumeration	0									
enumeration	1									
source	<code><xs:element name="BilingBilitCode" type="trex:PerfAckBilingBilitCode"/></code>									

element **PerfAckBilingBilitType/MetDate**

diagram							
type	trex:YMType						
properties	content simple						
facets	<table border="1"> <thead> <tr> <th>Kind</th> <th>Value</th> <th>Annotation</th> </tr> </thead> <tbody> <tr> <td>pattern</td> <td>[0-9]{4}-[01]?[0-9]</td> <td></td> </tr> </tbody> </table>	Kind	Value	Annotation	pattern	[0-9]{4}-[01]?[0-9]	
Kind	Value	Annotation					
pattern	[0-9]{4}-[01]?[0-9]						
source	<code><xs:element name="MetDate" type="trex:YMType"/></code>						

complexType **PerfAckCertLicType**

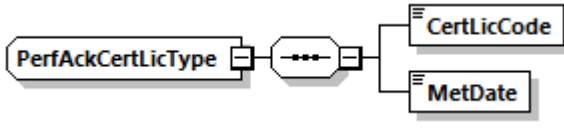
diagram	
namespace	urn:us:tx:state:tea:TREx:v1.16
children	CertLicCode MetDate
used by	element AcademicStatusType/CertLicType
source	<pre><xs:complexType name="PerfAckCertLicType"> <xs:sequence> <xs:element name="CertLicCode" type="trex:PerfAckCertLicCode"/> <xs:element name="MetDate" type="trex:YMType"/> </xs:sequence> </xs:complexType></pre>

element **PerfAckCertLicType/CertLicCode**

diagram										
type	trex:PerfAckCertLicCode									
properties	content simple									
facets	<table border="1"> <thead> <tr> <th>Kind</th> <th>Value</th> <th>Annotation</th> </tr> </thead> <tbody> <tr> <td>minLength</td> <td>1</td> <td></td> </tr> <tr> <td>maxLength</td> <td>61</td> <td></td> </tr> </tbody> </table>	Kind	Value	Annotation	minLength	1		maxLength	61	
Kind	Value	Annotation								
minLength	1									
maxLength	61									
source	<pre><xs:element name="CertLicCode" type="trex:PerfAckCertLicCode"/></pre>									

element **PerfAckCertLicType/MetDate**

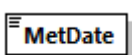
diagram							
type	trex:YMType						
properties	content simple						
facets	<table border="1"> <thead> <tr> <th>Kind</th> <th>Value</th> <th>Annotation</th> </tr> </thead> <tbody> <tr> <td>pattern</td> <td>[0-9]{4}-[01]?[0-9]</td> <td></td> </tr> </tbody> </table>	Kind	Value	Annotation	pattern	[0-9]{4}-[01]?[0-9]	
Kind	Value	Annotation					
pattern	[0-9]{4}-[01]?[0-9]						
source	<pre><xs:element name="MetDate" type="trex:YMType"/></pre>						

complexType **PerfAckCollegeAssessType**

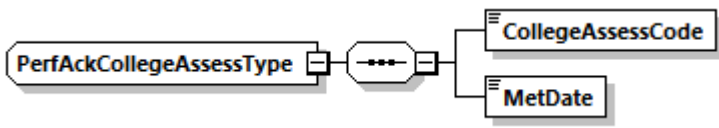
diagram	
namespace	urn:us:tx:state:tea:TREx:v1.16
children	CollegeAssessCode MetDate
used by	element AcademicStatusType/CollegeAssessType
source	<pre><xs:complexType name="PerfAckCollegeAssessType"> <xs:sequence> <xs:element name="CollegeAssessCode" type="trex:PerfAckCollegeAssessCode"/> <xs:element name="MetDate" type="trex:YMType"/> </xs:sequence> </xs:complexType></pre>

element **PerfAckCollegeAssessType/CollegeAssessCode**

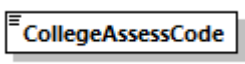
diagram																						
type	trex:PerfAckCollegeAssessCode																					
properties	content simple																					
facets	<table border="1"> <thead> <tr> <th>Kind</th> <th>Value</th> <th>Annotation</th> </tr> </thead> <tbody> <tr> <td>enumeration</td> <td>0</td> <td></td> </tr> <tr> <td>enumeration</td> <td>1</td> <td></td> </tr> <tr> <td>enumeration</td> <td>2</td> <td></td> </tr> <tr> <td>enumeration</td> <td>3</td> <td></td> </tr> <tr> <td>enumeration</td> <td>4</td> <td></td> </tr> <tr> <td>enumeration</td> <td>5</td> <td></td> </tr> </tbody> </table>	Kind	Value	Annotation	enumeration	0		enumeration	1		enumeration	2		enumeration	3		enumeration	4		enumeration	5	
Kind	Value	Annotation																				
enumeration	0																					
enumeration	1																					
enumeration	2																					
enumeration	3																					
enumeration	4																					
enumeration	5																					
source	<pre><xs:element name="CollegeAssessCode" type="trex:PerfAckCollegeAssessCode"/></pre>																					

element **PerfAckCollegeAssessType/MetDate**

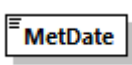
diagram							
type	trex:YMType						
properties	content simple						
facets	<table border="1"> <thead> <tr> <th>Kind</th> <th>Value</th> <th>Annotation</th> </tr> </thead> <tbody> <tr> <td>pattern</td> <td>[0-9]{4}-[01]?[0-9]</td> <td></td> </tr> </tbody> </table>	Kind	Value	Annotation	pattern	[0-9]{4}-[01]?[0-9]	
Kind	Value	Annotation					
pattern	[0-9]{4}-[01]?[0-9]						
source	<pre><xs:element name="MetDate" type="trex:YMType"/></pre>						

complexType **PerfAckDualCreditType**

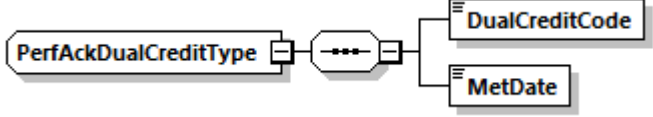
diagram	
namespace	urn:us:tx:state:tea:TREx:v1.16
children	DualCreditCode MetDate
used by	element AcademicStatusType/DualCreditType
source	<pre><xs:complexType name="PerfAckDualCreditType"> <xs:sequence> <xs:element name="DualCreditCode" type="trex:PerfAckDualCreditCode"/> <xs:element name="MetDate" type="trex:YMType"/> </xs:sequence> </xs:complexType></pre>

element **PerfAckDualCreditType/DualCreditCode**

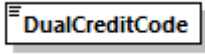
diagram													
type	trex:PerfAckDualCreditCode												
properties	content simple												
facets	<table border="1"> <thead> <tr> <th>Kind</th> <th>Value</th> <th>Annotation</th> </tr> </thead> <tbody> <tr> <td>enumeration</td> <td>0</td> <td></td> </tr> <tr> <td>enumeration</td> <td>1</td> <td></td> </tr> <tr> <td>enumeration</td> <td>2</td> <td></td> </tr> </tbody> </table>	Kind	Value	Annotation	enumeration	0		enumeration	1		enumeration	2	
Kind	Value	Annotation											
enumeration	0												
enumeration	1												
enumeration	2												
source	<pre><xs:element name="DualCreditCode" type="trex:PerfAckDualCreditCode"/></pre>												

element **PerfAckDualCreditType/MetDate**

diagram							
type	trex:YMType						
properties	content simple						
facets	<table border="1"> <thead> <tr> <th>Kind</th> <th>Value</th> <th>Annotation</th> </tr> </thead> <tbody> <tr> <td>pattern</td> <td>[0-9]{4}-[01]?[0-9]</td> <td></td> </tr> </tbody> </table>	Kind	Value	Annotation	pattern	[0-9]{4}-[01]?[0-9]	
Kind	Value	Annotation					
pattern	[0-9]{4}-[01]?[0-9]						
source	<pre><xs:element name="MetDate" type="trex:YMType"/></pre>						

complexType **PersonNameType**

diagram	<p>The diagram shows a complex type 'PersonNameType' containing a sequence of four elements: 'FirstName', 'MiddleName', 'LastName', and 'Suffix'. 'MiddleName' and 'Suffix' are shown with dashed boxes, indicating they are optional.</p>
namespace	urn:us:tx:state:tea:TREx:v1.16
children	FirstName MiddleName LastName Suffix
used by	elements ParentType/Name StudentIdentificationType/Name
source	<pre><xs:complexType name="PersonNameType"> <xs:sequence> <xs:element name="FirstName" type="trex:FirstNameType"/> <xs:element name="MiddleName" type="trex:MiddleNameType" minOccurs="0"/> <xs:element name="LastName" type="trex:LastNameType"/> <xs:element name="Suffix" type="trex:SuffixType" minOccurs="0"/> </xs:sequence> </xs:complexType></pre>

element **PersonNameType/FirstName**

diagram	<p>The diagram shows a simple element box labeled 'FirstName'.</p>									
type	trex:FirstNameType									
properties	content simple									
facets	<table border="1"> <thead> <tr> <th>Kind</th> <th>Value</th> <th>Annotation</th> </tr> </thead> <tbody> <tr> <td>minLength</td> <td>1</td> <td></td> </tr> <tr> <td>maxLength</td> <td>30</td> <td></td> </tr> </tbody> </table>	Kind	Value	Annotation	minLength	1		maxLength	30	
Kind	Value	Annotation								
minLength	1									
maxLength	30									
source	<pre><xs:element name="FirstName" type="trex:FirstNameType"/></pre>									

element **PersonNameType/MiddleName**

diagram	<p>The diagram shows a simple element box labeled 'MiddleName' with a dashed border, indicating it is optional.</p>									
type	trex:MiddleNameType									
properties	<table border="1"> <tbody> <tr> <td>minOcc</td> <td>0</td> </tr> <tr> <td>maxOcc</td> <td>1</td> </tr> <tr> <td>content</td> <td>simple</td> </tr> </tbody> </table>	minOcc	0	maxOcc	1	content	simple			
minOcc	0									
maxOcc	1									
content	simple									
facets	<table border="1"> <thead> <tr> <th>Kind</th> <th>Value</th> <th>Annotation</th> </tr> </thead> <tbody> <tr> <td>minLength</td> <td>1</td> <td></td> </tr> <tr> <td>maxLength</td> <td>30</td> <td></td> </tr> </tbody> </table>	Kind	Value	Annotation	minLength	1		maxLength	30	
Kind	Value	Annotation								
minLength	1									
maxLength	30									
source	<pre><xs:element name="MiddleName" type="trex:MiddleNameType" minOccurs="0"/></pre>									

element **PersonNameType/LastName**

diagram										
type	trex:LastNameType									
properties	content simple									
facets	<table border="1"> <thead> <tr> <th>Kind</th> <th>Value</th> <th>Annotation</th> </tr> </thead> <tbody> <tr> <td>minLength</td> <td>1</td> <td></td> </tr> <tr> <td>maxLength</td> <td>40</td> <td></td> </tr> </tbody> </table>	Kind	Value	Annotation	minLength	1		maxLength	40	
Kind	Value	Annotation								
minLength	1									
maxLength	40									
source	<code><xs:element name="LastName" type="trex:LastNameType"/></code>									

element **PersonNameType/Suffix**

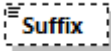
diagram																																								
type	trex:SuffixType																																							
properties	minOcc 0 maxOcc 1 content simple																																							
facets	<table border="1"> <thead> <tr> <th>Kind</th> <th>Value</th> <th>Annotation</th> </tr> </thead> <tbody> <tr><td>enumeration</td><td>1</td><td></td></tr> <tr><td>enumeration</td><td>2</td><td></td></tr> <tr><td>enumeration</td><td>3</td><td></td></tr> <tr><td>enumeration</td><td>4</td><td></td></tr> <tr><td>enumeration</td><td>5</td><td></td></tr> <tr><td>enumeration</td><td>6</td><td></td></tr> <tr><td>enumeration</td><td>7</td><td></td></tr> <tr><td>enumeration</td><td>8</td><td></td></tr> <tr><td>enumeration</td><td>9</td><td></td></tr> <tr><td>enumeration</td><td>A</td><td></td></tr> <tr><td>enumeration</td><td>B</td><td></td></tr> <tr><td>enumeration</td><td>C</td><td></td></tr> </tbody> </table>	Kind	Value	Annotation	enumeration	1		enumeration	2		enumeration	3		enumeration	4		enumeration	5		enumeration	6		enumeration	7		enumeration	8		enumeration	9		enumeration	A		enumeration	B		enumeration	C	
Kind	Value	Annotation																																						
enumeration	1																																							
enumeration	2																																							
enumeration	3																																							
enumeration	4																																							
enumeration	5																																							
enumeration	6																																							
enumeration	7																																							
enumeration	8																																							
enumeration	9																																							
enumeration	A																																							
enumeration	B																																							
enumeration	C																																							
source	<code><xs:element name="Suffix" type="trex:SuffixType" minOccurs="0"/></code>																																							

complexType **SchoolType**

diagram	
namespace	urn:us:tx:state:tea:TREx:v1.16
children	SchoolID SchoolName DistrictID DistrictName Address PhoneNumber Fax
used by	element StudentRecordType/School
source	<pre><xs:complexType name="SchoolType"> <xs:sequence> <xs:element name="SchoolID" type="trex:SchoolIDType"/> <xs:element name="SchoolName" type="trex:SchoolNameType"/> <xs:element name="DistrictID" type="trex:DistrictIDType"/> <xs:element name="DistrictName" type="trex:DistrictNameType" minOccurs="0"/> <xs:element name="Address" type="trex:AddressType" minOccurs="0"/> <xs:group ref="trex:PhoneNumberGroup"/> </xs:sequence> </xs:complexType></pre>

element **SchoolType/SchoolID**

diagram							
type	trex:SchoolIDType						
properties	content simple						
facets	<table border="1"> <thead> <tr> <th>Kind</th> <th>Value</th> <th>Annotation</th> </tr> </thead> <tbody> <tr> <td>pattern</td> <td>([0-9]{9})</td> <td></td> </tr> </tbody> </table>	Kind	Value	Annotation	pattern	([0-9]{9})	
Kind	Value	Annotation					
pattern	([0-9]{9})						
source	<pre><xs:element name="SchoolID" type="trex:SchoolIDType"/></pre>						

element **SchoolType/SchoolName**

diagram	
type	trex:SchoolNameType

properties	content simple									
facets	<table border="1"> <thead> <tr> <th>Kind</th> <th>Value</th> <th>Annotation</th> </tr> </thead> <tbody> <tr> <td>minLength</td> <td>1</td> <td></td> </tr> <tr> <td>maxLength</td> <td>34</td> <td></td> </tr> </tbody> </table>	Kind	Value	Annotation	minLength	1		maxLength	34	
Kind	Value	Annotation								
minLength	1									
maxLength	34									
source	<code><xs:element name="SchoolName" type="trex:SchoolNameType"/></code>									

element **SchoolType/DistrictID**

diagram							
type	trex:DistrictIDType						
properties	content simple						
facets	<table border="1"> <thead> <tr> <th>Kind</th> <th>Value</th> <th>Annotation</th> </tr> </thead> <tbody> <tr> <td>pattern</td> <td>([0-9]{6})</td> <td></td> </tr> </tbody> </table>	Kind	Value	Annotation	pattern	([0-9]{6})	
Kind	Value	Annotation					
pattern	([0-9]{6})						
source	<code><xs:element name="DistrictID" type="trex:DistrictIDType"/></code>						

element **SchoolType/DistrictName**

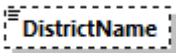
diagram										
type	trex:DistrictNameType									
properties	<table border="1"> <tbody> <tr> <td>minOcc</td> <td>0</td> </tr> <tr> <td>maxOcc</td> <td>1</td> </tr> <tr> <td>content</td> <td>simple</td> </tr> </tbody> </table>	minOcc	0	maxOcc	1	content	simple			
minOcc	0									
maxOcc	1									
content	simple									
facets	<table border="1"> <thead> <tr> <th>Kind</th> <th>Value</th> <th>Annotation</th> </tr> </thead> <tbody> <tr> <td>minLength</td> <td>1</td> <td></td> </tr> <tr> <td>maxLength</td> <td>34</td> <td></td> </tr> </tbody> </table>	Kind	Value	Annotation	minLength	1		maxLength	34	
Kind	Value	Annotation								
minLength	1									
maxLength	34									
source	<code><xs:element name="DistrictName" type="trex:DistrictNameType" minOccurs="0"/></code>									

element **SchoolType/Address**

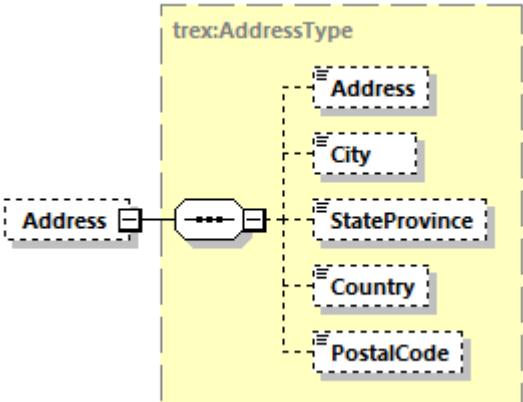
diagram	
---------	---

type	trex:AddressType
properties	minOcc 0 maxOcc 1 content complex
children	Address City StateProvince Country PostalCode
source	<code><xs:element name="Address" type="trex:AddressType" minOccurs="0"/></code>

complexType **SpecialProgramsType**

diagram	
namespace	urn:us:tx:state:tea:TREx:v1.16
children	LEP EconomicDisadvantaged AtRisk Title SpecialEd IEP Bilingual ESL GiftedTalented CTE PersonalGradPlan
used by	element StudentRecordType/SpecialPrograms
source	<pre> <xs:complexType name="SpecialProgramsType"> <xs:sequence> <xs:element name="LEP" type="trex:LEPType" minOccurs="0"/> <xs:element name="EconomicDisadvantaged" type="trex:EconomicDisadvantagedType" minOccurs="0"/> <xs:element name="AtRisk" type="trex:ParticipationType" minOccurs="0"/> <xs:element name="TitleI" type="trex:TitleIType" minOccurs="0"/> <xs:element name="SpecialEd" type="trex:ParticipationType" minOccurs="0"/> <xs:element name="IEP" type="trex:ParticipationType" minOccurs="0"/> <xs:element name="Bilingual" type="trex:BilingualType" minOccurs="0"/> <xs:element name="ESL" type="trex:ESLType" minOccurs="0"/> <xs:element name="GiftedTalented" type="trex:GiftedTalentedType" minOccurs="0"/> <xs:element name="CTE" type="trex:CareerTechEdType" minOccurs="0"/> </pre>

	<pre><xs:element name="PersonalGradPlan" type="trex:ParticipationType" minOccurs="0"/> </xs:sequence> </xs:complexType></pre>
--	---

element **SpecialProgramsType/LEP**

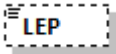
diagram																
type	trex:LEPType															
properties	minOcc 0 maxOcc 1 content simple															
facets	<table border="1"> <thead> <tr> <th>Kind</th> <th>Value</th> <th>Annotation</th> </tr> </thead> <tbody> <tr> <td>enumeration</td> <td>0</td> <td></td> </tr> <tr> <td>enumeration</td> <td>1</td> <td></td> </tr> <tr> <td>enumeration</td> <td>F</td> <td></td> </tr> <tr> <td>enumeration</td> <td>S</td> <td></td> </tr> </tbody> </table>	Kind	Value	Annotation	enumeration	0		enumeration	1		enumeration	F		enumeration	S	
Kind	Value	Annotation														
enumeration	0															
enumeration	1															
enumeration	F															
enumeration	S															
source	<pre><xs:element name="LEP" type="trex:LEPType" minOccurs="0"/></pre>															

element **SpecialProgramsType/EconomicDisadvantaged**

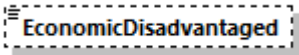
diagram																
type	trex:EconomicDisadvantagedType															
properties	minOcc 0 maxOcc 1 content simple															
facets	<table border="1"> <thead> <tr> <th>Kind</th> <th>Value</th> <th>Annotation</th> </tr> </thead> <tbody> <tr> <td>enumeration</td> <td>00</td> <td></td> </tr> <tr> <td>enumeration</td> <td>01</td> <td></td> </tr> <tr> <td>enumeration</td> <td>02</td> <td></td> </tr> <tr> <td>enumeration</td> <td>99</td> <td></td> </tr> </tbody> </table>	Kind	Value	Annotation	enumeration	00		enumeration	01		enumeration	02		enumeration	99	
Kind	Value	Annotation														
enumeration	00															
enumeration	01															
enumeration	02															
enumeration	99															
source	<pre><xs:element name="EconomicDisadvantaged" type="trex:EconomicDisadvantagedType" minOccurs="0"/></pre>															

element **SpecialProgramsType/AtRisk**

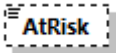
diagram							
type	trex:ParticipationType						
properties	minOcc 0 maxOcc 1 content simple						
facets	<table border="1"> <thead> <tr> <th>Kind</th> <th>Value</th> <th>Annotation</th> </tr> </thead> <tbody> <tr> <td>enumeration</td> <td>0</td> <td></td> </tr> </tbody> </table>	Kind	Value	Annotation	enumeration	0	
Kind	Value	Annotation					
enumeration	0						

	enumeration 1
source	<code><xs:element name="AtRisk" type="trex:ParticipationType" minOccurs="0"/></code>

element **SpecialProgramsType/TitleI**

diagram																						
type	trex:TitleIType																					
properties	minOcc 0 maxOcc 1 content simple																					
facets	<table border="1"> <thead> <tr> <th>Kind</th> <th>Value</th> <th>Annotation</th> </tr> </thead> <tbody> <tr> <td>enumeration</td> <td>0</td> <td></td> </tr> <tr> <td>enumeration</td> <td>A</td> <td></td> </tr> <tr> <td>enumeration</td> <td>6</td> <td></td> </tr> <tr> <td>enumeration</td> <td>7</td> <td></td> </tr> <tr> <td>enumeration</td> <td>8</td> <td></td> </tr> <tr> <td>enumeration</td> <td>9</td> <td></td> </tr> </tbody> </table>	Kind	Value	Annotation	enumeration	0		enumeration	A		enumeration	6		enumeration	7		enumeration	8		enumeration	9	
Kind	Value	Annotation																				
enumeration	0																					
enumeration	A																					
enumeration	6																					
enumeration	7																					
enumeration	8																					
enumeration	9																					
source	<code><xs:element name="TitleI" type="trex:TitleIType" minOccurs="0"/></code>																					

element **SpecialProgramsType/SpecialEd**

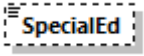
diagram										
type	trex:ParticipationType									
properties	minOcc 0 maxOcc 1 content simple									
facets	<table border="1"> <thead> <tr> <th>Kind</th> <th>Value</th> <th>Annotation</th> </tr> </thead> <tbody> <tr> <td>enumeration</td> <td>0</td> <td></td> </tr> <tr> <td>enumeration</td> <td>1</td> <td></td> </tr> </tbody> </table>	Kind	Value	Annotation	enumeration	0		enumeration	1	
Kind	Value	Annotation								
enumeration	0									
enumeration	1									
source	<code><xs:element name="SpecialEd" type="trex:ParticipationType" minOccurs="0"/></code>									

element **SpecialProgramsType/IEP**

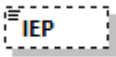
diagram										
type	trex:ParticipationType									
properties	minOcc 0 maxOcc 1 content simple									
facets	<table border="1"> <thead> <tr> <th>Kind</th> <th>Value</th> <th>Annotation</th> </tr> </thead> <tbody> <tr> <td>enumeration</td> <td>0</td> <td></td> </tr> <tr> <td>enumeration</td> <td>1</td> <td></td> </tr> </tbody> </table>	Kind	Value	Annotation	enumeration	0		enumeration	1	
Kind	Value	Annotation								
enumeration	0									
enumeration	1									

source	<code><xs:element name="IEP" type="trex:ParticipationType" minOccurs="0"/></code>
--------	---

element **SpecialProgramsType/Bilingual**

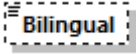
diagram																						
type	trex:BilingualType																					
properties	minOcc 0 maxOcc 1 content simple																					
facets	<table border="1"> <thead> <tr> <th>Kind</th> <th>Value</th> <th>Annotation</th> </tr> </thead> <tbody> <tr> <td>enumeration</td> <td>0</td> <td></td> </tr> <tr> <td>enumeration</td> <td>1</td> <td></td> </tr> <tr> <td>enumeration</td> <td>2</td> <td></td> </tr> <tr> <td>enumeration</td> <td>3</td> <td></td> </tr> <tr> <td>enumeration</td> <td>4</td> <td></td> </tr> <tr> <td>enumeration</td> <td>5</td> <td></td> </tr> </tbody> </table>	Kind	Value	Annotation	enumeration	0		enumeration	1		enumeration	2		enumeration	3		enumeration	4		enumeration	5	
Kind	Value	Annotation																				
enumeration	0																					
enumeration	1																					
enumeration	2																					
enumeration	3																					
enumeration	4																					
enumeration	5																					
source	<code><xs:element name="Bilingual" type="trex:BilingualType" minOccurs="0"/></code>																					

element **SpecialProgramsType/ESL**

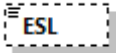
diagram																
type	trex:ESLType															
properties	minOcc 0 maxOcc 1 content simple															
facets	<table border="1"> <thead> <tr> <th>Kind</th> <th>Value</th> <th>Annotation</th> </tr> </thead> <tbody> <tr> <td>enumeration</td> <td>0</td> <td></td> </tr> <tr> <td>enumeration</td> <td>1</td> <td></td> </tr> <tr> <td>enumeration</td> <td>2</td> <td></td> </tr> <tr> <td>enumeration</td> <td>3</td> <td></td> </tr> </tbody> </table>	Kind	Value	Annotation	enumeration	0		enumeration	1		enumeration	2		enumeration	3	
Kind	Value	Annotation														
enumeration	0															
enumeration	1															
enumeration	2															
enumeration	3															
source	<code><xs:element name="ESL" type="trex:ESLType" minOccurs="0"/></code>															

element **SpecialProgramsType/GiftedTalented**

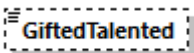
diagram										
type	trex:GiftedTalentedType									
properties	minOcc 0 maxOcc 1 content simple									
facets	<table border="1"> <thead> <tr> <th>Kind</th> <th>Value</th> <th>Annotation</th> </tr> </thead> <tbody> <tr> <td>enumeration</td> <td>0</td> <td></td> </tr> <tr> <td>enumeration</td> <td>1</td> <td></td> </tr> </tbody> </table>	Kind	Value	Annotation	enumeration	0		enumeration	1	
Kind	Value	Annotation								
enumeration	0									
enumeration	1									

	enumeration 2
source	<code><xs:element name="GiftedTalented" type="trex:GiftedTalentedType" minOccurs="0"/></code>

element **SpecialProgramsType/CTE**

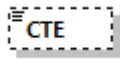
diagram																
type	trex:CareerTechEdType															
properties	minOcc 0 maxOcc 1 content simple															
facets	<table border="0"> <thead> <tr> <th>Kind</th> <th>Value</th> <th>Annotation</th> </tr> </thead> <tbody> <tr> <td>enumeration</td> <td>0</td> <td></td> </tr> <tr> <td>enumeration</td> <td>1</td> <td></td> </tr> <tr> <td>enumeration</td> <td>2</td> <td></td> </tr> <tr> <td>enumeration</td> <td>3</td> <td></td> </tr> </tbody> </table>	Kind	Value	Annotation	enumeration	0		enumeration	1		enumeration	2		enumeration	3	
Kind	Value	Annotation														
enumeration	0															
enumeration	1															
enumeration	2															
enumeration	3															
source	<code><xs:element name="CTE" type="trex:CareerTechEdType" minOccurs="0"/></code>															

element **SpecialProgramsType/PersonalGradPlan**

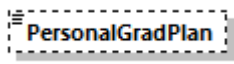
diagram										
type	trex:ParticipationType									
properties	minOcc 0 maxOcc 1 content simple									
facets	<table border="0"> <thead> <tr> <th>Kind</th> <th>Value</th> <th>Annotation</th> </tr> </thead> <tbody> <tr> <td>enumeration</td> <td>0</td> <td></td> </tr> <tr> <td>enumeration</td> <td>1</td> <td></td> </tr> </tbody> </table>	Kind	Value	Annotation	enumeration	0		enumeration	1	
Kind	Value	Annotation								
enumeration	0									
enumeration	1									
source	<code><xs:element name="PersonalGradPlan" type="trex:ParticipationType" minOccurs="0"/></code>									

complexType **StudentDemographicType**

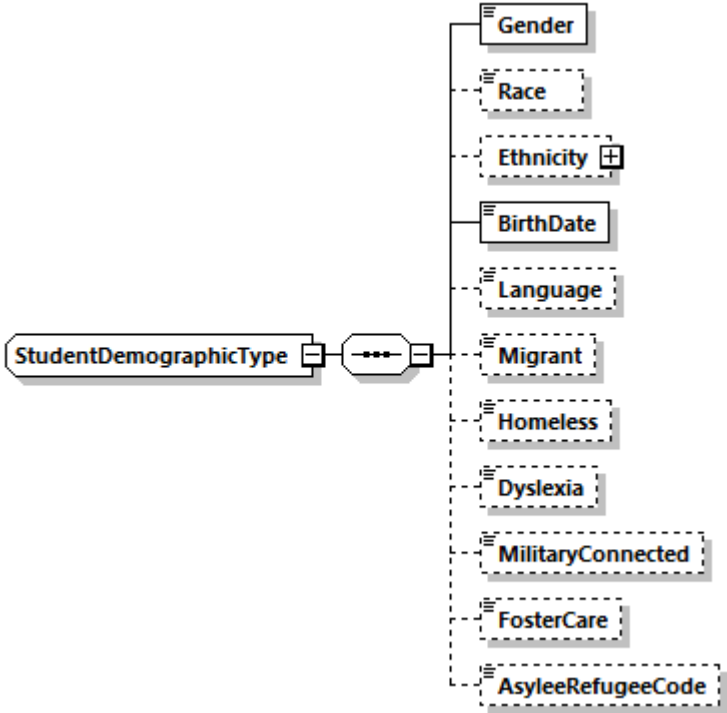
<p>diagram</p>	
<p>namespace</p>	<p>urn:us:tx:state:tea:TREx:v1.16</p>
<p>children</p>	<p>Gender Race Ethnicity BirthDate Language Migrant Homeless Dyslexia MilitaryConnected FosterCare AsyleeRefugeeCode</p>
<p>used by</p>	<p>element StudentRecordType/StudentDemographic</p>
<p>source</p>	<pre><xs:complexType name="StudentDemographicType"> <xs:sequence> <xs:element name="Gender" type="trex:GenderType"/> <xs:element name="Race" type="trex:RaceType" minOccurs="0"/> <xs:element name="Ethnicity" type="trex:EthnicityType" minOccurs="0"/> <xs:element name="BirthDate" type="trex:YMDType"/> <xs:element name="Language" type="trex:LanguageType" minOccurs="0"/> <xs:element name="Migrant" type="trex:ParticipationType" minOccurs="0"/> <xs:element name="Homeless" type="trex:HomelessType" minOccurs="0"/> <xs:element name="Dyslexia" type="trex:ParticipationType" minOccurs="0"/> <xs:element name="MilitaryConnected" type="trex:MilitaryConnectedType" minOccurs="0"/> <xs:element name="FosterCare" type="trex:FosterCareType" minOccurs="0"/> <xs:element name="AsyleeRefugeeCode" type="trex:AsyleeRefugeeCodeType" minOccurs="0"/> </xs:sequence> </xs:complexType></pre>

element **StudentDemographicType/Gender**

<p>diagram</p>	
----------------	---

type	trex:GenderType									
properties	content simple									
facets	<table border="1"> <thead> <tr> <th>Kind</th> <th>Value</th> <th>Annotation</th> </tr> </thead> <tbody> <tr> <td>enumeration</td> <td>F</td> <td></td> </tr> <tr> <td>enumeration</td> <td>M</td> <td></td> </tr> </tbody> </table>	Kind	Value	Annotation	enumeration	F		enumeration	M	
Kind	Value	Annotation								
enumeration	F									
enumeration	M									
source	<code><xs:element name="Gender" type="trex:GenderType"/></code>									

element **StudentDemographicType/Race**

diagram																			
type	trex:RaceType																		
properties	<table border="1"> <tr> <td>minOcc</td> <td>0</td> </tr> <tr> <td>maxOcc</td> <td>1</td> </tr> <tr> <td>content</td> <td>simple</td> </tr> </table>	minOcc	0	maxOcc	1	content	simple												
minOcc	0																		
maxOcc	1																		
content	simple																		
facets	<table border="1"> <thead> <tr> <th>Kind</th> <th>Value</th> <th>Annotation</th> </tr> </thead> <tbody> <tr> <td>enumeration</td> <td>1</td> <td></td> </tr> <tr> <td>enumeration</td> <td>2</td> <td></td> </tr> <tr> <td>enumeration</td> <td>3</td> <td></td> </tr> <tr> <td>enumeration</td> <td>4</td> <td></td> </tr> <tr> <td>enumeration</td> <td>5</td> <td></td> </tr> </tbody> </table>	Kind	Value	Annotation	enumeration	1		enumeration	2		enumeration	3		enumeration	4		enumeration	5	
Kind	Value	Annotation																	
enumeration	1																		
enumeration	2																		
enumeration	3																		
enumeration	4																		
enumeration	5																		
source	<code><xs:element name="Race" type="trex:RaceType" minOccurs="0"/></code>																		

element **StudentDemographicType/Ethnicity**

diagram							
type	trex:EthnicityType						
properties	<table border="1"> <tr> <td>minOcc</td> <td>0</td> </tr> <tr> <td>maxOcc</td> <td>1</td> </tr> <tr> <td>content</td> <td>complex</td> </tr> </table>	minOcc	0	maxOcc	1	content	complex
minOcc	0						
maxOcc	1						
content	complex						
children	AmericanIndianAlaskaNativeCode AsianCode BlackAfricanAmericanCode HispanicLatinoCode NativeHawaiianPacificIslanderCode WhiteCode						

source	<code><xs:element name="Ethnicity" type="trex:EthnicityType" minOccurs="0"/></code>
--------	---

element **StudentDemographicType/BirthDate**

diagram							
type	trex:YMDType						
properties	content simple						
facets	<table border="1"> <thead> <tr> <th>Kind</th> <th>Value</th> <th>Annotation</th> </tr> </thead> <tbody> <tr> <td>pattern</td> <td>[0-9]{4}-[01]?[0-9]-[0123]?[0-9]</td> <td></td> </tr> </tbody> </table>	Kind	Value	Annotation	pattern	[0-9]{4}-[01]?[0-9]-[0123]?[0-9]	
Kind	Value	Annotation					
pattern	[0-9]{4}-[01]?[0-9]-[0123]?[0-9]						
source	<code><xs:element name="BirthDate" type="trex:YMDType"/></code>						

element **StudentDemographicType/Language**

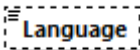
diagram																																																																									
type	trex:LanguageType																																																																								
properties	minOcc 0 maxOcc 1 content simple																																																																								
facets	<table border="1"> <thead> <tr> <th>Kind</th> <th>Value</th> <th>Annotation</th> </tr> </thead> <tbody> <tr><td>enumeration</td><td>01</td><td></td></tr> <tr><td>enumeration</td><td>02</td><td></td></tr> <tr><td>enumeration</td><td>03</td><td></td></tr> <tr><td>enumeration</td><td>04</td><td></td></tr> <tr><td>enumeration</td><td>06</td><td></td></tr> <tr><td>enumeration</td><td>07</td><td></td></tr> <tr><td>enumeration</td><td>08</td><td></td></tr> <tr><td>enumeration</td><td>09</td><td></td></tr> <tr><td>enumeration</td><td>98</td><td></td></tr> <tr><td>enumeration</td><td>99</td><td></td></tr> <tr><td>enumeration</td><td>1A</td><td></td></tr> <tr><td>enumeration</td><td>1B</td><td></td></tr> <tr><td>enumeration</td><td>1C</td><td></td></tr> <tr><td>enumeration</td><td>1D</td><td></td></tr> <tr><td>enumeration</td><td>1E</td><td></td></tr> <tr><td>enumeration</td><td>1F</td><td></td></tr> <tr><td>enumeration</td><td>1G</td><td></td></tr> <tr><td>enumeration</td><td>1H</td><td></td></tr> <tr><td>enumeration</td><td>1I</td><td></td></tr> <tr><td>enumeration</td><td>1J</td><td></td></tr> <tr><td>enumeration</td><td>1K</td><td></td></tr> <tr><td>enumeration</td><td>1L</td><td></td></tr> <tr><td>enumeration</td><td>1M</td><td></td></tr> </tbody> </table>	Kind	Value	Annotation	enumeration	01		enumeration	02		enumeration	03		enumeration	04		enumeration	06		enumeration	07		enumeration	08		enumeration	09		enumeration	98		enumeration	99		enumeration	1A		enumeration	1B		enumeration	1C		enumeration	1D		enumeration	1E		enumeration	1F		enumeration	1G		enumeration	1H		enumeration	1I		enumeration	1J		enumeration	1K		enumeration	1L		enumeration	1M	
Kind	Value	Annotation																																																																							
enumeration	01																																																																								
enumeration	02																																																																								
enumeration	03																																																																								
enumeration	04																																																																								
enumeration	06																																																																								
enumeration	07																																																																								
enumeration	08																																																																								
enumeration	09																																																																								
enumeration	98																																																																								
enumeration	99																																																																								
enumeration	1A																																																																								
enumeration	1B																																																																								
enumeration	1C																																																																								
enumeration	1D																																																																								
enumeration	1E																																																																								
enumeration	1F																																																																								
enumeration	1G																																																																								
enumeration	1H																																																																								
enumeration	1I																																																																								
enumeration	1J																																																																								
enumeration	1K																																																																								
enumeration	1L																																																																								
enumeration	1M																																																																								

enumeration	1N
enumeration	1O
enumeration	1P
enumeration	1Q
enumeration	1R
enumeration	1S
enumeration	1T
enumeration	1U
enumeration	1V
enumeration	1W
enumeration	1X
enumeration	1Y
enumeration	1Z
enumeration	2A
enumeration	2B
enumeration	2C
enumeration	2D
enumeration	2E
enumeration	2F
enumeration	2G
enumeration	2H
enumeration	2I
enumeration	2J
enumeration	2K
enumeration	2L
enumeration	2M
enumeration	2N
enumeration	2O
enumeration	2P
enumeration	2Q
enumeration	2R
enumeration	2S
enumeration	2T
enumeration	2U
enumeration	2V
enumeration	2W
enumeration	2X
enumeration	2Y
enumeration	2Z
enumeration	3A
enumeration	3B
enumeration	3C
enumeration	3D
enumeration	3E
enumeration	3F

enumeration	3G
enumeration	3H
enumeration	3I
enumeration	3J
enumeration	3K
enumeration	3L
enumeration	3M
enumeration	3N
enumeration	3O
enumeration	3P
enumeration	3Q
enumeration	3R
enumeration	3S
enumeration	3T
enumeration	3U
enumeration	3V
enumeration	3W
enumeration	3X
enumeration	3Y
enumeration	3Z
enumeration	4A
enumeration	4B
enumeration	4C
enumeration	4D
enumeration	4E
enumeration	4F
enumeration	4G
enumeration	4H
enumeration	4I
enumeration	4J
enumeration	4K
enumeration	4L
enumeration	4M
enumeration	4N
enumeration	4O
enumeration	4P
enumeration	4Q
enumeration	4R
enumeration	4S
enumeration	4T
enumeration	4U
enumeration	4V
enumeration	4W
enumeration	4X
enumeration	4Y

	enumeration 4Z enumeration 5A enumeration 5B enumeration 5C enumeration 5D enumeration 5E enumeration 5F enumeration 5G enumeration 5H enumeration 5I enumeration 5J enumeration 5K enumeration 5L enumeration 5M enumeration 5N enumeration 5O enumeration 5P enumeration 5Q enumeration 5R enumeration 5S enumeration 5T enumeration 5U enumeration 5V enumeration 5W enumeration 5X enumeration 5Y enumeration 5Z enumeration 6A
source	<code><xs:element name="Language" type="trex:LanguageType" minOccurs="0"/></code>

element **StudentDemographicType/Migrant**

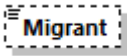
diagram										
type	trex:ParticipationType									
properties	minOcc 0 maxOcc 1 content simple									
facets	<table border="1"> <thead> <tr> <th>Kind</th> <th>Value</th> <th>Annotation</th> </tr> </thead> <tbody> <tr> <td>enumeration</td> <td>0</td> <td></td> </tr> <tr> <td>enumeration</td> <td>1</td> <td></td> </tr> </tbody> </table>	Kind	Value	Annotation	enumeration	0		enumeration	1	
Kind	Value	Annotation								
enumeration	0									
enumeration	1									
source	<code><xs:element name="Migrant" type="trex:ParticipationType" minOccurs="0"/></code>									

element **StudentDemographicType/Homeless**

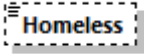
diagram																						
type	trex:HomelessType																					
properties	minOcc 0 maxOcc 1 content simple																					
facets	<table border="1"> <thead> <tr> <th>Kind</th> <th>Value</th> <th>Annotation</th> </tr> </thead> <tbody> <tr> <td>enumeration</td> <td>0</td> <td></td> </tr> <tr> <td>enumeration</td> <td>1</td> <td></td> </tr> <tr> <td>enumeration</td> <td>2</td> <td></td> </tr> <tr> <td>enumeration</td> <td>3</td> <td></td> </tr> <tr> <td>enumeration</td> <td>4</td> <td></td> </tr> <tr> <td>enumeration</td> <td>5</td> <td></td> </tr> </tbody> </table>	Kind	Value	Annotation	enumeration	0		enumeration	1		enumeration	2		enumeration	3		enumeration	4		enumeration	5	
Kind	Value	Annotation																				
enumeration	0																					
enumeration	1																					
enumeration	2																					
enumeration	3																					
enumeration	4																					
enumeration	5																					
source	<code><xs:element name="Homeless" type="trex:HomelessType" minOccurs="0"/></code>																					

element **StudentDemographicType/Dyslexia**

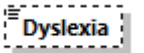
diagram										
type	trex:ParticipationType									
properties	minOcc 0 maxOcc 1 content simple									
facets	<table border="1"> <thead> <tr> <th>Kind</th> <th>Value</th> <th>Annotation</th> </tr> </thead> <tbody> <tr> <td>enumeration</td> <td>0</td> <td></td> </tr> <tr> <td>enumeration</td> <td>1</td> <td></td> </tr> </tbody> </table>	Kind	Value	Annotation	enumeration	0		enumeration	1	
Kind	Value	Annotation								
enumeration	0									
enumeration	1									
source	<code><xs:element name="Dyslexia" type="trex:ParticipationType" minOccurs="0"/></code>									

element **StudentDemographicType/MilitaryConnected**

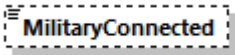
diagram																			
type	trex:MilitaryConnectedType																		
properties	minOcc 0 maxOcc 1 content simple																		
facets	<table border="1"> <thead> <tr> <th>Kind</th> <th>Value</th> <th>Annotation</th> </tr> </thead> <tbody> <tr> <td>enumeration</td> <td>0</td> <td></td> </tr> <tr> <td>enumeration</td> <td>1</td> <td></td> </tr> <tr> <td>enumeration</td> <td>2</td> <td></td> </tr> <tr> <td>enumeration</td> <td>3</td> <td></td> </tr> <tr> <td>enumeration</td> <td>4</td> <td></td> </tr> </tbody> </table>	Kind	Value	Annotation	enumeration	0		enumeration	1		enumeration	2		enumeration	3		enumeration	4	
Kind	Value	Annotation																	
enumeration	0																		
enumeration	1																		
enumeration	2																		
enumeration	3																		
enumeration	4																		
source	<code><xs:element name="MilitaryConnected" type="trex:MilitaryConnectedType" minOccurs="0"/></code>																		

element **StudentDemographicType/FosterCare**

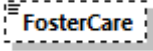
diagram													
type	trex:FosterCareType												
properties	minOcc 0 maxOcc 1 content simple												
facets	<table border="1"> <thead> <tr> <th>Kind</th> <th>Value</th> <th>Annotation</th> </tr> </thead> <tbody> <tr> <td>enumeration</td> <td>0</td> <td></td> </tr> <tr> <td>enumeration</td> <td>1</td> <td></td> </tr> <tr> <td>enumeration</td> <td>2</td> <td></td> </tr> </tbody> </table>	Kind	Value	Annotation	enumeration	0		enumeration	1		enumeration	2	
Kind	Value	Annotation											
enumeration	0												
enumeration	1												
enumeration	2												
source	<code><xs:element name="FosterCare" type="trex:FosterCareType" minOccurs="0"/></code>												

element **StudentDemographicType/AsyleeRefugeeCode**

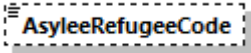
diagram													
type	trex:AsyleeRefugeeCodeType												
properties	minOcc 0 maxOcc 1 content simple												
facets	<table border="1"> <thead> <tr> <th>Kind</th> <th>Value</th> <th>Annotation</th> </tr> </thead> <tbody> <tr> <td>enumeration</td> <td>0</td> <td></td> </tr> <tr> <td>enumeration</td> <td>1</td> <td></td> </tr> <tr> <td>enumeration</td> <td>2</td> <td></td> </tr> </tbody> </table>	Kind	Value	Annotation	enumeration	0		enumeration	1		enumeration	2	
Kind	Value	Annotation											
enumeration	0												
enumeration	1												
enumeration	2												
source	<code><xs:element name="AsyleeRefugeeCode" type="trex:AsyleeRefugeeCodeType" minOccurs="0"/></code>												

complexType **StudentIdentificationType**

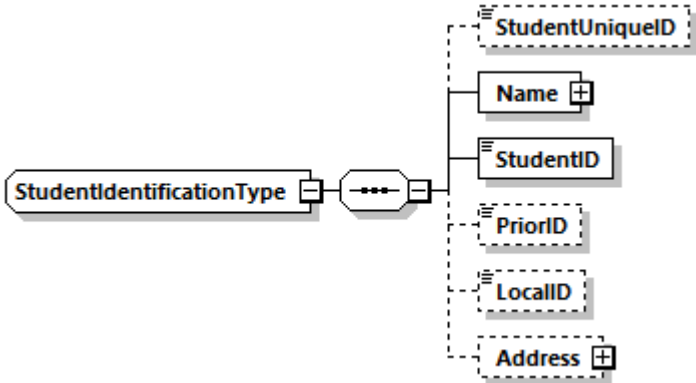
diagram	
namespace	urn:us:tx:state:tea:TREx:v1.16

children	StudentUniqueID Name StudentID PriorID LocalID Address
used by	element StudentRecordType/StudentIdentification
source	<pre><xs:complexType name="StudentIdentificationType"> <xs:sequence> <xs:element name="StudentUniqueID" type="trex:StudentUniqueIDType" minOccurs="0"/> <xs:element name="Name" type="trex:PersonNameType"/> <xs:element name="StudentID" type="trex:StudentIDType"/> <xs:element name="PriorID" type="trex:PriorIDType" minOccurs="0"/> <xs:element name="LocalID" type="trex:LocalIDType" minOccurs="0"/> <xs:element name="Address" type="trex:AddressType" minOccurs="0"/> </xs:sequence> </xs:complexType></pre>

element [StudentIdentificationType/StudentUniqueID](#)

diagram	
type	trex:StudentUniqueIDType
properties	minOcc 0 maxOcc 1 content simple
facets	Kind Value Annotation pattern [0-9]{10}
source	<pre><xs:element name="StudentUniqueID" type="trex:StudentUniqueIDType" minOccurs="0"/></pre>

element [StudentIdentificationType/Name](#)

diagram	
type	trex:PersonNameType
properties	content complex
children	FirstName MiddleName LastName Suffix
source	<pre><xs:element name="Name" type="trex:PersonNameType"/></pre>

element **StudentIdentificationType/StudentID**

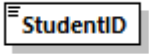
diagram										
type	trex:StudentIDType									
properties	content simple									
facets	<table border="1"> <thead> <tr> <th>Kind</th> <th>Value</th> <th>Annotation</th> </tr> </thead> <tbody> <tr> <td>minLength</td> <td>1</td> <td></td> </tr> <tr> <td>maxLength</td> <td>64</td> <td></td> </tr> </tbody> </table>	Kind	Value	Annotation	minLength	1		maxLength	64	
Kind	Value	Annotation								
minLength	1									
maxLength	64									
source	<code><xs:element name="StudentID" type="trex:StudentIDType"/></code>									

element **StudentIdentificationType/PriorID**

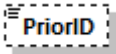
diagram										
type	trex:PriorIDType									
properties	minOcc 0 maxOcc 1 content simple									
facets	<table border="1"> <thead> <tr> <th>Kind</th> <th>Value</th> <th>Annotation</th> </tr> </thead> <tbody> <tr> <td>minLength</td> <td>1</td> <td></td> </tr> <tr> <td>maxLength</td> <td>9</td> <td></td> </tr> </tbody> </table>	Kind	Value	Annotation	minLength	1		maxLength	9	
Kind	Value	Annotation								
minLength	1									
maxLength	9									
source	<code><xs:element name="PriorID" type="trex:PriorIDType" minOccurs="0"/></code>									

element **StudentIdentificationType/LocalID**

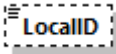
diagram										
type	trex:LocalIDType									
properties	minOcc 0 maxOcc 1 content simple									
facets	<table border="1"> <thead> <tr> <th>Kind</th> <th>Value</th> <th>Annotation</th> </tr> </thead> <tbody> <tr> <td>minLength</td> <td>1</td> <td></td> </tr> <tr> <td>maxLength</td> <td>9</td> <td></td> </tr> </tbody> </table>	Kind	Value	Annotation	minLength	1		maxLength	9	
Kind	Value	Annotation								
minLength	1									
maxLength	9									
source	<code><xs:element name="LocalID" type="trex:LocalIDType" minOccurs="0"/></code>									

element **StudentIdentificationType/Address**

diagram	
type	trex:AddressType
properties	minOcc 0 maxOcc 1 content complex
children	Address City StateProvince Country PostalCode
source	<code><xs:element name="Address" type="trex:AddressType" minOccurs="0"/></code>

complexType **StudentRecordsType**

diagram	
namespace	urn:us:tx:state:tea:TReX:v1.16
children	TReXStudentRecord
used by	element TReXStudentRecords
source	<pre> <xs:complexType name="StudentRecordsType"> <xs:sequence> <xs:element name="TReXStudentRecord" type="trex:StudentRecordType" maxOccurs="unbounded"/> </xs:sequence> </xs:complexType> </pre>

element **StudentRecordsType/TReXStudentRecord**

<p>diagram</p>	
<p>type</p>	<p>trex:StudentRecordType</p>
<p>properties</p>	<p>minOcc 1 maxOcc unbounded content complex</p>
<p>children</p>	<p>StudentIdentification Parent StudentDemographic School Enrollment SpecialPrograms Assessment Attendance Immunization DisciplineAction AcademicStatus CurrentCoursework AcademicSession AcademicSummary</p>
<p>source</p>	<pre><xs:element name="TReXStudentRecord" type="trex:StudentRecordType" maxOccurs="unbounded"/></pre>

complexType **StudentRecordType**

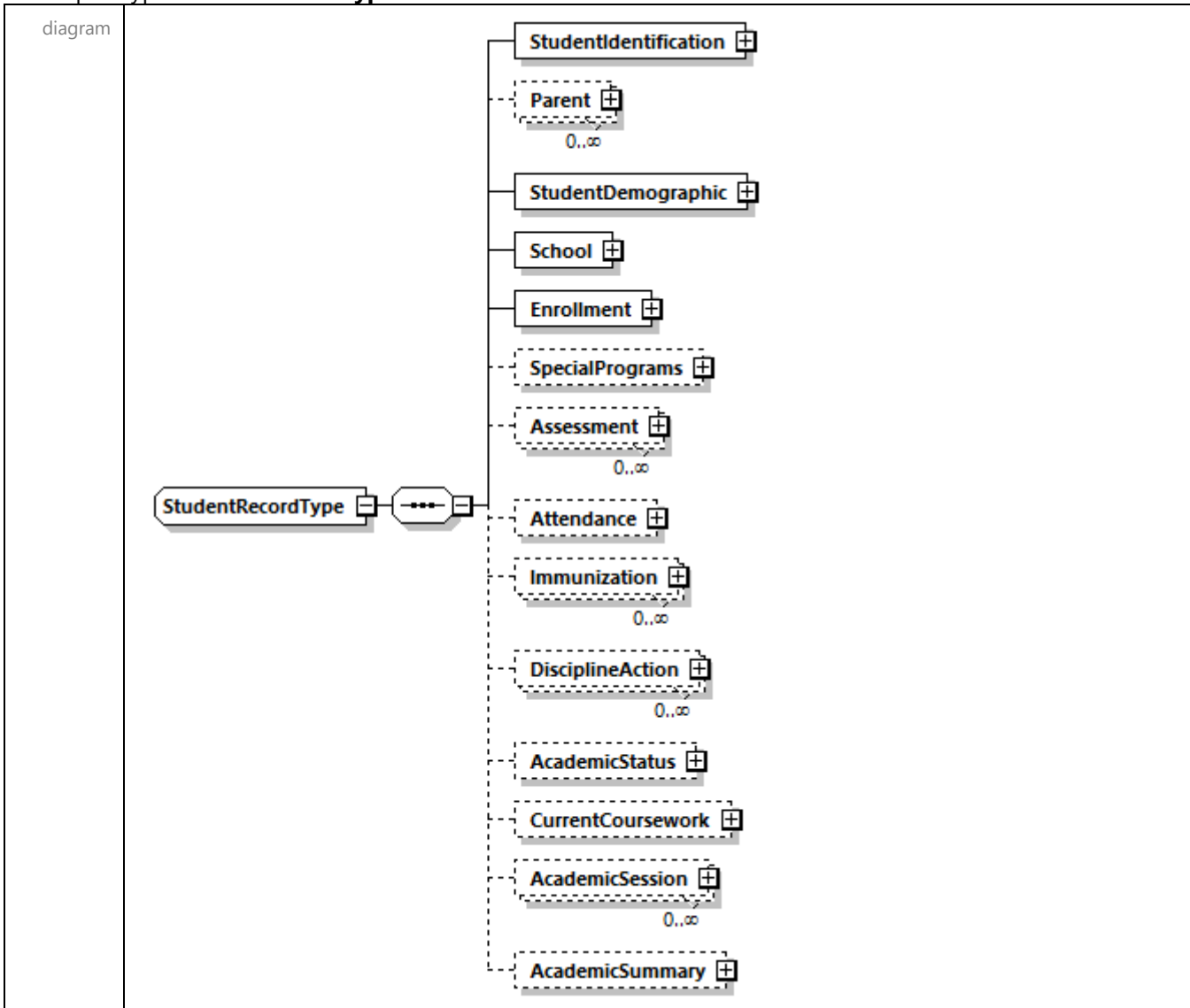

namespace urn:us:tx:state:tea:TREx:v1.16

children [StudentIdentification](#) [Parent](#) [StudentDemographic](#) [School](#) [Enrollment](#) [SpecialPrograms](#) [Assessment](#) [Attendance](#) [Immunization](#) [DisciplineAction](#) [AcademicStatus](#) [CurrentCoursework](#) [AcademicSession](#) [AcademicSummary](#)

used by element [StudentRecordsType/TRExStudentRecord](#)

```

<xs:complexType name="StudentRecordType">
  <xs:sequence>
    <xs:element name="StudentIdentification"
      type="trex:StudentIdentificationType"/>
    <xs:element name="Parent" type="trex:ParentType" minOccurs="0"
      maxOccurs="unbounded"/>
    <xs:element name="StudentDemographic" type="trex:StudentDemographicType"/>
    <xs:element name="School" type="trex:SchoolType"/>
    <xs:element name="Enrollment" type="trex:EnrollmentType"/>
    <xs:element name="SpecialPrograms" type="trex:SpecialProgramsType"
      minOccurs="0"/>
  
```

```

<xs:element name="Assessment" type="trex:AssessmentType" minOccurs="0"
maxOccurs="unbounded"/>
<xs:element name="Attendance" type="trex:AttendanceType" minOccurs="0"/>
<xs:element name="Immunization" type="trex:ImmunizationType" minOccurs="0"
maxOccurs="unbounded"/>
<xs:element name="DisciplineAction" type="trex:DisciplineActionType"
minOccurs="0" maxOccurs="unbounded"/>
<xs:element name="AcademicStatus" type="trex:AcademicStatusType"
minOccurs="0"/>
<xs:element name="CurrentCoursework" type="trex:CurrentCourseworkType"
minOccurs="0"/>
<xs:element name="AcademicSession" type="trex:AcademicSessionType"
minOccurs="0" maxOccurs="unbounded"/>
<xs:element name="AcademicSummary" type="trex:AcademicSummaryType"
minOccurs="0"/>
</xs:sequence>
</xs:complexType>
  
```

element **StudentRecordType/StudentIdentification**

diagram	
type	trex:StudentIdentificationType
properties	content complex
children	StudentUniqueID Name StudentID PriorID LocalID Address
source	<code><xs:element name="StudentIdentification" type="trex:StudentIdentificationType"/></code>

element **StudentRecordType/Parent**

diagram	
type	trex:ParentType

properties	minOcc 0 maxOcc unbounded content complex
children	Name
source	<code><xs:element name="Parent" type="trex:ParentType" minOccurs="0" maxOccurs="unbounded"/></code>

element **StudentRecordType/StudentDemographic**

diagram	
type	trex:StudentDemographicType
properties	content complex
children	Gender Race Ethnicity BirthDate Language Migrant Homeless Dyslexia MilitaryConnected FosterCare AsyleeRefugeeCode
source	<code><xs:element name="StudentDemographic" type="trex:StudentDemographicType"/></code>

element **StudentRecordType/School**

diagram	
type	trex:SchoolType
properties	content complex
children	SchoolID SchoolName DistrictID DistrictName Address PhoneNumber Fax
source	<code><xs:element name="School" type="trex:SchoolType"/></code>

element **StudentRecordType/Enrollment**

diagram	
type	trex:EnrollmentType
properties	content complex
children	GradeLevel EntryDate ExitDate WithdrawDate WithdrawReason GradePlaced GradePromoted GradeRetained

source	<code><xs:element name="Enrollment" type="trex:EnrollmentType"/></code>
--------	---

element **StudentRecordType/SpecialPrograms**

diagram	<p>The diagram illustrates the structure of the <code>SpecialPrograms</code> element. It is a complex type containing a <code>trex:SpecialProgramsType</code> element. This type includes the following child elements: <code>LEP</code>, <code>EconomicDisadvantaged</code>, <code>AtRisk</code>, <code>TitleI</code>, <code>SpecialEd</code>, <code>IEP</code>, <code>Bilingual</code>, <code>ESL</code>, <code>GiftedTalented</code>, <code>CTE</code>, and <code>PersonalGradPlan</code>.</p>
type	trex:SpecialProgramsType
properties	minOcc 0 maxOcc 1 content complex
children	LEP EconomicDisadvantaged AtRisk TitleI SpecialEd IEP Bilingual ESL GiftedTalented CTE PersonalGradPlan
source	<code><xs:element name="SpecialPrograms" type="trex:SpecialProgramsType" minOccurs="0"/></code>

element **StudentRecordType/Assessment**

diagram	
type	trex:AssessmentType
properties	minOcc 0 maxOcc unbounded content complex
children	TestName AdditionalTestName TestLevel TestDate ExitRequirementMetDate TestScore TestCode PerformanceLevel AssessmentSubTest
source	<code><xs:element name="Assessment" type="trex:AssessmentType" minOccurs="0" maxOccurs="unbounded"/></code>

element **StudentRecordType/Attendance**

diagram	
type	trex:AttendanceType
properties	minOcc 0 maxOcc 1 content complex
children	DaysAttended DaysAbsent
source	<code><xs:element name="Attendance" type="trex:AttendanceType" minOccurs="0"/></code>

element **StudentRecordType/Immunization**

diagram	<p>The diagram illustrates the structure of the <code>Immunization</code> element. It is a complex type containing three child elements: <code>ImmunizationCode</code>, <code>ImmunizationDate</code>, and <code>ImmunizationDose</code>. The <code>Immunization</code> element has a cardinality of <code>0..∞</code>.</p>
type	trex:ImmunizationType
properties	minOcc 0 maxOcc unbounded content complex
children	ImmunizationCode ImmunizationDate ImmunizationDose
source	<code><xs:element name="Immunization" type="trex:ImmunizationType" minOccurs="0" maxOccurs="unbounded"/></code>

element **StudentRecordType/DisciplineAction**

diagram	<p>The diagram illustrates the structure of the <code>DisciplineAction</code> element. It is a complex type containing four child elements: <code>DisciplineActionDate</code>, <code>DisciplineActionNum</code>, <code>DisciplineActionCode</code>, and <code>DisciplineActionReason</code>. The <code>DisciplineAction</code> element has a cardinality of <code>0..∞</code>.</p>
type	trex:DisciplineActionType
properties	minOcc 0 maxOcc unbounded content complex
children	DisciplineActionDate DisciplineActionNum DisciplineActionCode DisciplineActionReason
source	<code><xs:element name="DisciplineAction" type="trex:DisciplineActionType" minOccurs="0" maxOccurs="unbounded"/></code>

element **StudentRecordType/AcademicStatus**

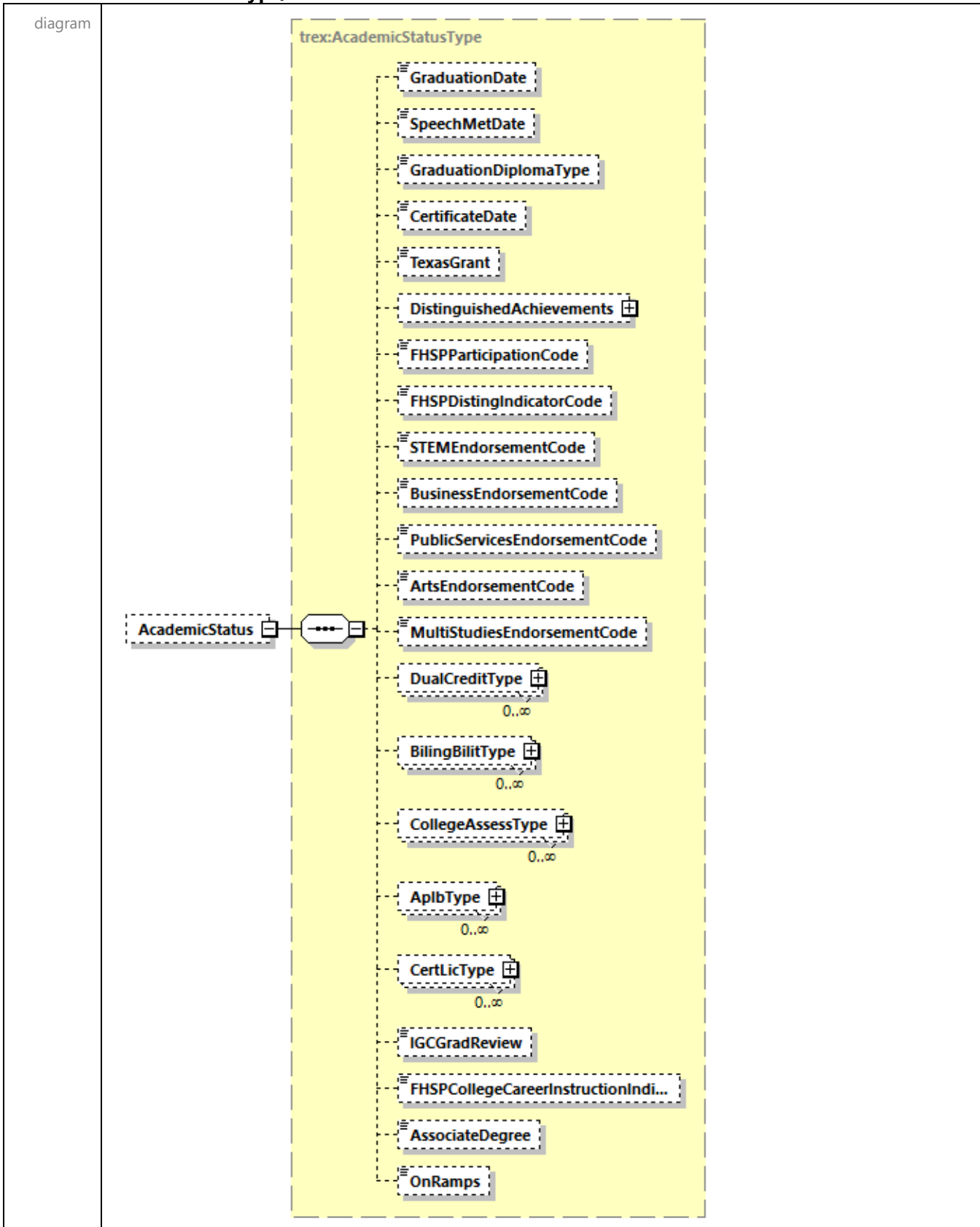

type	trex:AcademicStatusType
properties	minOcc 0 maxOcc 1 content complex
children	GraduationDate SpeechMetDate GraduationDiplomaType CertificateDate TexasGrant DistinguishedAchievements FHSPParticipationCode FHSPDistingIndicatorCode STEMEndorsementCode BusinessEndorsementCode PublicServicesEndorsementCode ArtsEndorsementCode MultiStudiesEndorsementCode DualCreditType BilingBilitType CollegeAssessType AplbType CertLicType IGCGradReview FHSPCollegeCareerInstructionIndicator AssociateDegree OnRamps
source	<code><xs:element name="AcademicStatus" type="trex:AcademicStatusType" minOccurs="0"/></code>

element **StudentRecordType/CurrentCoursework**

diagram	
type	trex:CurrentCourseworkType
properties	minOcc 0 maxOcc 1 content complex
children	Course SchoolYear GradeLevel SessionType
source	<code><xs:element name="CurrentCoursework" type="trex:CurrentCourseworkType" minOccurs="0"/></code>

element **StudentRecordType/AcademicSession**

diagram	<p>The diagram shows the structure of the <code>trex:AcademicSessionType</code>. The root element is <code>AcademicSession</code> with a cardinality of <code>0..∞</code>. It contains a sequence of five child elements: <code>SchoolYear</code> (1..∞), <code>GradeLevel</code>, <code>SessionType</code>, <code>Course</code> (1..∞), and <code>AcademicSummary</code>.</p>
type	trex:AcademicSessionType
properties	minOcc 0 maxOcc unbounded content complex
children	SchoolYear GradeLevel SessionType Course AcademicSummary
source	<pre><xs:element name="AcademicSession" type="trex:AcademicSessionType" minOccurs="0" maxOccurs="unbounded"/></pre>

element **StudentRecordType/AcademicSummary**

diagram	<p>The diagram shows the structure of the <code>trex:AcademicSummaryType</code>. The root element is <code>AcademicSummary</code>. It contains a sequence of six child elements: <code>GPA</code>, <code>ClassTotalNumber</code>, <code>ClassRank</code>, <code>ClassRankingDate</code>, <code>Quartile</code>, and <code>CollegeCampusCode</code>.</p>
type	trex:AcademicSummaryType
properties	minOcc 0 maxOcc 1 content complex
children	GPA ClassTotalNumber ClassRank ClassRankingDate Quartile CollegeCampusCode
source	<pre><xs:element name="AcademicSummary" type="trex:AcademicSummaryType" minOccurs="0"/></pre>

simpleType **AbbreviationType**

namespace	urn:us:tx:state:tea:TREx:v1.16									
type	restriction of xs:token									
properties	base xs:token									
used by	element CourseType/Abbreviation									
facets	<table border="1"> <thead> <tr> <th>Kind</th> <th>Value</th> <th>Annotation</th> </tr> </thead> <tbody> <tr> <td>minLength</td> <td>1</td> <td></td> </tr> <tr> <td>maxLength</td> <td>100</td> <td></td> </tr> </tbody> </table>	Kind	Value	Annotation	minLength	1		maxLength	100	
Kind	Value	Annotation								
minLength	1									
maxLength	100									
source	<pre><xs:simpleType name="AbbreviationType"> <xs:restriction base="xs:token"> <xs:minLength value="1"/> <xs:maxLength value="100"/> </xs:restriction> </xs:simpleType></pre>									

simpleType **AdditionalTestNameType**

namespace	urn:us:tx:state:tea:TREx:v1.16									
type	restriction of xs:token									
properties	base xs:token									
used by	element AssessmentType/AdditionalTestName									
facets	<table border="1"> <thead> <tr> <th>Kind</th> <th>Value</th> <th>Annotation</th> </tr> </thead> <tbody> <tr> <td>minLength</td> <td>1</td> <td></td> </tr> <tr> <td>maxLength</td> <td>60</td> <td></td> </tr> </tbody> </table>	Kind	Value	Annotation	minLength	1		maxLength	60	
Kind	Value	Annotation								
minLength	1									
maxLength	60									
source	<pre><xs:simpleType name="AdditionalTestNameType"> <xs:restriction base="xs:token"> <xs:minLength value="1"/> <xs:maxLength value="60"/> </xs:restriction> </xs:simpleType></pre>									

simpleType **AddressStringType**

namespace	urn:us:tx:state:tea:TREx:v1.16									
type	restriction of xs:token									
properties	base xs:token									
used by	element AddressType/Address									
facets	<table border="1"> <thead> <tr> <th>Kind</th> <th>Value</th> <th>Annotation</th> </tr> </thead> <tbody> <tr> <td>minLength</td> <td>1</td> <td></td> </tr> <tr> <td>maxLength</td> <td>50</td> <td></td> </tr> </tbody> </table>	Kind	Value	Annotation	minLength	1		maxLength	50	
Kind	Value	Annotation								
minLength	1									
maxLength	50									
source	<pre><xs:simpleType name="AddressStringType"></pre>									

```
<xs:restriction base="xs:token">
  <xs:minLength value="1"/>
  <xs:maxLength value="50"/>
</xs:restriction>
</xs:simpleType>
```

simpleType **AdvancedMeasureType**

namespace	urn:us:tx:state:tea:TREx:v1.16																					
type	restriction of xs:token																					
properties	base xs:token																					
used by	element DistinguishedAchievementType/AdvancedMeasure																					
facets	<table border="1"> <thead> <tr> <th>Kind</th> <th>Value</th> <th>Annotation</th> </tr> </thead> <tbody> <tr> <td>enumeration</td> <td>A</td> <td></td> </tr> <tr> <td>enumeration</td> <td>B</td> <td></td> </tr> <tr> <td>enumeration</td> <td>C</td> <td></td> </tr> <tr> <td>enumeration</td> <td>D</td> <td></td> </tr> <tr> <td>enumeration</td> <td>E</td> <td></td> </tr> <tr> <td>enumeration</td> <td>F</td> <td></td> </tr> </tbody> </table>	Kind	Value	Annotation	enumeration	A		enumeration	B		enumeration	C		enumeration	D		enumeration	E		enumeration	F	
Kind	Value	Annotation																				
enumeration	A																					
enumeration	B																					
enumeration	C																					
enumeration	D																					
enumeration	E																					
enumeration	F																					
source	<pre><xs:simpleType name="AdvancedMeasureType"> <xs:restriction base="xs:token"> <xs:enumeration value="A"/> <xs:enumeration value="B"/> <xs:enumeration value="C"/> <xs:enumeration value="D"/> <xs:enumeration value="E"/> <xs:enumeration value="F"/> <!-- Original research/project --> <!-- AP score 3 or above --> <!-- B score 4 or above. --> <!-- Qualifying PSAT score --> <!-- College course - 3.0 or higher --> <!-- Articulated course - 3.0 or higher --> </xs:restriction> </xs:simpleType></pre>																					

simpleType **AsyleeRefugeeCodeType**

namespace	urn:us:tx:state:tea:TREx:v1.16												
type	restriction of xs:token												
properties	base xs:token												
used by	element StudentDemographicType/AsyleeRefugeeCode												
facets	<table border="1"> <thead> <tr> <th>Kind</th> <th>Value</th> <th>Annotation</th> </tr> </thead> <tbody> <tr> <td>enumeration</td> <td>0</td> <td></td> </tr> <tr> <td>enumeration</td> <td>1</td> <td></td> </tr> <tr> <td>enumeration</td> <td>2</td> <td></td> </tr> </tbody> </table>	Kind	Value	Annotation	enumeration	0		enumeration	1		enumeration	2	
Kind	Value	Annotation											
enumeration	0												
enumeration	1												
enumeration	2												

source	<pre><xs:simpleType name="AsyleeRefugeeCodeType"> <xs:restriction base="xs:token"> <xs:enumeration value="0"/> <xs:enumeration value="1"/> <xs:enumeration value="2"/> <!-- Not applicable to this student --> <!-- Asylee --> <!-- Refugee --> </xs:restriction> </xs:simpleType></pre>
--------	--

simpleType **BilingualType**

namespace	urn:us:tx:state:tea:TREx:v1.16																					
type	restriction of xs:token																					
properties	base xs:token																					
used by	element SpecialProgramsType/Bilingual																					
facets	<table border="1"> <thead> <tr> <th>Kind</th> <th>Value</th> <th>Annotation</th> </tr> </thead> <tbody> <tr> <td>enumeration</td> <td>0</td> <td></td> </tr> <tr> <td>enumeration</td> <td>1</td> <td></td> </tr> <tr> <td>enumeration</td> <td>2</td> <td></td> </tr> <tr> <td>enumeration</td> <td>3</td> <td></td> </tr> <tr> <td>enumeration</td> <td>4</td> <td></td> </tr> <tr> <td>enumeration</td> <td>5</td> <td></td> </tr> </tbody> </table>	Kind	Value	Annotation	enumeration	0		enumeration	1		enumeration	2		enumeration	3		enumeration	4		enumeration	5	
Kind	Value	Annotation																				
enumeration	0																					
enumeration	1																					
enumeration	2																					
enumeration	3																					
enumeration	4																					
enumeration	5																					
source	<pre><xs:simpleType name="BilingualType"> <xs:restriction base="xs:token"> <xs:enumeration value="0"/> <xs:enumeration value="1"/> <xs:enumeration value="2"/> <xs:enumeration value="3"/> <xs:enumeration value="4"/> <xs:enumeration value="5"/> <!-- Not receiving services. --> <!-- Participant in program or service. --> <!-- Transitional bilingual/early exit. --> <!-- Transitional bilingual/late exit. --> <!-- Dual language immersion/two-way. --> <!-- Dual language immersion/one-way. --> </xs:restriction> </xs:simpleType></pre>																					

simpleType **CareerTechEdType**

namespace	urn:us:tx:state:tea:TREx:v1.16
type	restriction of xs:token
properties	base xs:token

used by	element SpecialProgramsType/CTE															
facets	<table border="1"> <thead> <tr> <th>Kind</th> <th>Value</th> <th>Annotation</th> </tr> </thead> <tbody> <tr> <td>enumeration</td> <td>0</td> <td></td> </tr> <tr> <td>enumeration</td> <td>1</td> <td></td> </tr> <tr> <td>enumeration</td> <td>2</td> <td></td> </tr> <tr> <td>enumeration</td> <td>3</td> <td></td> </tr> </tbody> </table>	Kind	Value	Annotation	enumeration	0		enumeration	1		enumeration	2		enumeration	3	
Kind	Value	Annotation														
enumeration	0															
enumeration	1															
enumeration	2															
enumeration	3															
source	<pre><xs:simpleType name="CareerTechEdType"> <xs:restriction base="xs:token"> <xs:enumeration value="0"/> <xs:enumeration value="1"/> <xs:enumeration value="2"/> <xs:enumeration value="3"/> <!-- Not enrolled in a CTE course --> <!-- Enrolled in a CTE course --> <!-- Participant in a coherent sequence of courses --> <!-- Participant in Tech Prep program --> </xs:restriction> </xs:simpleType></pre>															

simpleType **CityType**

namespace	urn:us:tx:state:tea:TREx:v1.16									
type	restriction of xs:token									
properties	base xs:token									
used by	element AddressType/City									
facets	<table border="1"> <thead> <tr> <th>Kind</th> <th>Value</th> <th>Annotation</th> </tr> </thead> <tbody> <tr> <td>minLength</td> <td>1</td> <td></td> </tr> <tr> <td>maxLength</td> <td>30</td> <td></td> </tr> </tbody> </table>	Kind	Value	Annotation	minLength	1		maxLength	30	
Kind	Value	Annotation								
minLength	1									
maxLength	30									
source	<pre><xs:simpleType name="CityType"> <xs:restriction base="xs:token"> <xs:minLength value="1"/> <xs:maxLength value="30"/> </xs:restriction> </xs:simpleType></pre>									

simpleType **ClassPeriodType**

namespace	urn:us:tx:state:tea:TREx:v1.16									
type	restriction of xs:token									
properties	base xs:token									
used by	element CourseType/ClassPeriod									
facets	<table border="1"> <thead> <tr> <th>Kind</th> <th>Value</th> <th>Annotation</th> </tr> </thead> <tbody> <tr> <td>minLength</td> <td>1</td> <td></td> </tr> <tr> <td>maxLength</td> <td>5</td> <td></td> </tr> </tbody> </table>	Kind	Value	Annotation	minLength	1		maxLength	5	
Kind	Value	Annotation								
minLength	1									
maxLength	5									
source	<pre><xs:simpleType name="ClassPeriodType"></pre>									

	<pre><xs:restriction base="xs:token"> <xs:minLength value="1"/> <xs:maxLength value="5"/> </xs:restriction> </xs:simpleType></pre>
--	--

simpleType **ClassRankType**

namespace	urn:us:tx:state:tea:TREx:v1.16						
type	restriction of xs:integer						
properties	base xs:integer						
used by	element AcademicSummaryType/ClassRank						
facets	<table border="1"> <thead> <tr> <th>Kind</th> <th>Value</th> <th>Annotation</th> </tr> </thead> <tbody> <tr> <td>totalDigits</td> <td>5</td> <td></td> </tr> </tbody> </table>	Kind	Value	Annotation	totalDigits	5	
Kind	Value	Annotation					
totalDigits	5						
source	<pre><xs:simpleType name="ClassRankType"> <xs:restriction base="xs:integer"> <xs:totalDigits value="5"/> </xs:restriction> </xs:simpleType></pre>						

simpleType **ClassTotalNumberType**

namespace	urn:us:tx:state:tea:TREx:v1.16						
type	restriction of xs:integer						
properties	base xs:integer						
used by	element AcademicSummaryType/ClassTotalNumber						
facets	<table border="1"> <thead> <tr> <th>Kind</th> <th>Value</th> <th>Annotation</th> </tr> </thead> <tbody> <tr> <td>totalDigits</td> <td>5</td> <td></td> </tr> </tbody> </table>	Kind	Value	Annotation	totalDigits	5	
Kind	Value	Annotation					
totalDigits	5						
source	<pre><xs:simpleType name="ClassTotalNumberType"> <xs:restriction base="xs:integer"> <xs:totalDigits value="5"/> </xs:restriction> </xs:simpleType></pre>						

simpleType **CollegeCampusCodeType**

namespace	urn:us:tx:state:tea:TREx:v1.16						
type	restriction of xs:token						
properties	base xs:token						
used by	element AcademicSummaryType/CollegeCampusCode						
facets	<table border="1"> <thead> <tr> <th>Kind</th> <th>Value</th> <th>Annotation</th> </tr> </thead> <tbody> <tr> <td>pattern</td> <td>([0-9]{6})</td> <td></td> </tr> </tbody> </table>	Kind	Value	Annotation	pattern	([0-9]{6})	
Kind	Value	Annotation					
pattern	([0-9]{6})						
source	<pre><xs:simpleType name="CollegeCampusCodeType"></pre>						

```
<xs:restriction base="xs:token">
  <xs:pattern value="([0-9]{6})"/>
</xs:restriction>
</xs:simpleType>
```

simpleType **CountryType**

namespace	urn:us:tx:state:tea:TREx:v1.16		
type	restriction of xs:token		
properties	base xs:token		
used by	element AddressType/Country		
facets	Kind	Value	Annotation
	enumeration	US	
	enumeration	AD	
	enumeration	AE	
	enumeration	AF	
	enumeration	AG	
	enumeration	AI	
	enumeration	AL	
	enumeration	AM	
	enumeration	AN	
	enumeration	AO	
	enumeration	AQ	
	enumeration	AR	
	enumeration	AS	
	enumeration	AT	
	enumeration	AU	
	enumeration	AW	
	enumeration	AX	
	enumeration	AZ	
	enumeration	BA	
	enumeration	BB	
	enumeration	BD	
	enumeration	BE	
	enumeration	BF	
	enumeration	BG	
	enumeration	BH	
	enumeration	BI	
	enumeration	BJ	
	enumeration	BM	
	enumeration	BN	
	enumeration	BO	
	enumeration	BR	
	enumeration	BS	
	enumeration	BT	

enumeration	BV
enumeration	BW
enumeration	BY
enumeration	BZ
enumeration	CA
enumeration	CC
enumeration	CD
enumeration	CF
enumeration	CG
enumeration	CH
enumeration	CI
enumeration	CK
enumeration	CL
enumeration	CM
enumeration	CN
enumeration	CO
enumeration	CR
enumeration	CS
enumeration	CU
enumeration	CV
enumeration	CX
enumeration	CY
enumeration	CZ
enumeration	DE
enumeration	DJ
enumeration	DK
enumeration	DM
enumeration	DO
enumeration	DZ
enumeration	EC
enumeration	EE
enumeration	EG
enumeration	EH
enumeration	ER
enumeration	ES
enumeration	ET
enumeration	FI
enumeration	FJ
enumeration	FK
enumeration	FM
enumeration	FO
enumeration	FR
enumeration	GA
enumeration	GB
enumeration	GD

enumeration	GE
enumeration	GF
enumeration	GH
enumeration	GI
enumeration	GL
enumeration	GM
enumeration	GN
enumeration	GP
enumeration	GQ
enumeration	GR
enumeration	GS
enumeration	GT
enumeration	GU
enumeration	GW
enumeration	GY
enumeration	HK
enumeration	HM
enumeration	HN
enumeration	HR
enumeration	HT
enumeration	HU
enumeration	ID
enumeration	IE
enumeration	IL
enumeration	IN
enumeration	IO
enumeration	IQ
enumeration	IR
enumeration	IS
enumeration	IT
enumeration	JM
enumeration	JO
enumeration	JP
enumeration	KE
enumeration	KG
enumeration	KH
enumeration	KI
enumeration	KM
enumeration	KN
enumeration	KP
enumeration	KR
enumeration	KW
enumeration	KY
enumeration	KZ
enumeration	LA

enumeration	LB
enumeration	LC
enumeration	LI
enumeration	LK
enumeration	LR
enumeration	LS
enumeration	LT
enumeration	LU
enumeration	LV
enumeration	LY
enumeration	MA
enumeration	MC
enumeration	MD
enumeration	MG
enumeration	MH
enumeration	MK
enumeration	ML
enumeration	MM
enumeration	MN
enumeration	MO
enumeration	MP
enumeration	MQ
enumeration	MR
enumeration	MS
enumeration	MT
enumeration	MU
enumeration	MV
enumeration	MW
enumeration	MX
enumeration	MY
enumeration	MZ
enumeration	NA
enumeration	NC
enumeration	NE
enumeration	NF
enumeration	NG
enumeration	NI
enumeration	NL
enumeration	NO
enumeration	NP
enumeration	NR
enumeration	NU
enumeration	NZ
enumeration	OM
enumeration	PA

enumeration	PE
enumeration	PF
enumeration	PG
enumeration	PH
enumeration	PK
enumeration	PL
enumeration	PM
enumeration	PN
enumeration	PR
enumeration	PS
enumeration	PT
enumeration	PW
enumeration	PY
enumeration	QA
enumeration	RE
enumeration	RO
enumeration	RU
enumeration	RW
enumeration	SA
enumeration	SB
enumeration	SC
enumeration	SD
enumeration	SE
enumeration	SG
enumeration	SH
enumeration	SI
enumeration	SJ
enumeration	SK
enumeration	SL
enumeration	SM
enumeration	SN
enumeration	SO
enumeration	SR
enumeration	ST
enumeration	SV
enumeration	SY
enumeration	SZ
enumeration	TC
enumeration	TD
enumeration	TF
enumeration	TG
enumeration	TH
enumeration	TJ
enumeration	TK
enumeration	TL

	enumeration TM enumeration TN enumeration TO enumeration TR enumeration TT enumeration TV enumeration TW enumeration TZ enumeration UA enumeration UG enumeration UM enumeration UY enumeration UZ enumeration VA enumeration VC enumeration VE enumeration VG enumeration VI enumeration VN enumeration VU enumeration WF enumeration WS enumeration YE enumeration YT enumeration ZA enumeration ZM enumeration ZW
source	<pre> <xs:simpleType name="CountryType"> <xs:restriction base="xs:token"> <xs:enumeration value="US"/> <xs:enumeration value="AD"/> <xs:enumeration value="AE"/> <xs:enumeration value="AF"/> <xs:enumeration value="AG"/> <xs:enumeration value="AI"/> <xs:enumeration value="AL"/> <xs:enumeration value="AM"/> <xs:enumeration value="AN"/> <xs:enumeration value="AO"/> <xs:enumeration value="AQ"/> <xs:enumeration value="AR"/> <xs:enumeration value="AS"/> <xs:enumeration value="AT"/> <xs:enumeration value="AU"/> <xs:enumeration value="AW"/> <xs:enumeration value="AX"/> <xs:enumeration value="AZ"/> <xs:enumeration value="BA"/> <xs:enumeration value="BB"/> </pre>

```
<xs:enumeration value="BD"/>  
<xs:enumeration value="BE"/>  
<xs:enumeration value="BF"/>  
<xs:enumeration value="BG"/>  
<xs:enumeration value="BH"/>  
<xs:enumeration value="BI"/>  
<xs:enumeration value="BJ"/>  
<xs:enumeration value="BM"/>  
<xs:enumeration value="BN"/>  
<xs:enumeration value="BO"/>  
<xs:enumeration value="BR"/>  
<xs:enumeration value="BS"/>  
<xs:enumeration value="BT"/>  
<xs:enumeration value="BV"/>  
<xs:enumeration value="BW"/>  
<xs:enumeration value="BY"/>  
<xs:enumeration value="BZ"/>  
<xs:enumeration value="CA"/>  
<xs:enumeration value="CC"/>  
<xs:enumeration value="CD"/>  
<xs:enumeration value="CF"/>  
<xs:enumeration value="CG"/>  
<xs:enumeration value="CH"/>  
<xs:enumeration value="CI"/>  
<xs:enumeration value="CK"/>  
<xs:enumeration value="CL"/>  
<xs:enumeration value="CM"/>  
<xs:enumeration value="CN"/>  
<xs:enumeration value="CO"/>  
<xs:enumeration value="CR"/>  
<xs:enumeration value="CS"/>  
<xs:enumeration value="CU"/>  
<xs:enumeration value="CV"/>  
<xs:enumeration value="CX"/>  
<xs:enumeration value="CY"/>  
<xs:enumeration value="CZ"/>  
<xs:enumeration value="DE"/>  
<xs:enumeration value="DJ"/>  
<xs:enumeration value="DK"/>  
<xs:enumeration value="DM"/>  
<xs:enumeration value="DO"/>  
<xs:enumeration value="DZ"/>  
<xs:enumeration value="EC"/>  
<xs:enumeration value="EE"/>  
<xs:enumeration value="EG"/>  
<xs:enumeration value="EH"/>  
<xs:enumeration value="ER"/>  
<xs:enumeration value="ES"/>  
<xs:enumeration value="ET"/>  
<xs:enumeration value="FI"/>  
<xs:enumeration value="FJ"/>  
<xs:enumeration value="FK"/>  
<xs:enumeration value="FM"/>  
<xs:enumeration value="FO"/>  
<xs:enumeration value="FR"/>
```

```
<xs:enumeration value="GA"/>  
<xs:enumeration value="GB"/>  
<xs:enumeration value="GD"/>  
<xs:enumeration value="GE"/>  
<xs:enumeration value="GF"/>  
<xs:enumeration value="GH"/>  
<xs:enumeration value="GI"/>  
<xs:enumeration value="GL"/>  
<xs:enumeration value="GM"/>  
<xs:enumeration value="GN"/>  
<xs:enumeration value="GP"/>  
<xs:enumeration value="GQ"/>  
<xs:enumeration value="GR"/>  
<xs:enumeration value="GS"/>  
<xs:enumeration value="GT"/>  
<xs:enumeration value="GU"/>  
<xs:enumeration value="GW"/>  
<xs:enumeration value="GY"/>  
<xs:enumeration value="HK"/>  
<xs:enumeration value="HM"/>  
<xs:enumeration value="HN"/>  
<xs:enumeration value="HR"/>  
<xs:enumeration value="HT"/>  
<xs:enumeration value="HU"/>  
<xs:enumeration value="ID"/>  
<xs:enumeration value="IE"/>  
<xs:enumeration value="IL"/>  
<xs:enumeration value="IN"/>  
<xs:enumeration value="IO"/>  
<xs:enumeration value="IQ"/>  
<xs:enumeration value="IR"/>  
<xs:enumeration value="IS"/>  
<xs:enumeration value="IT"/>  
<xs:enumeration value="JM"/>  
<xs:enumeration value="JO"/>  
<xs:enumeration value="JP"/>  
<xs:enumeration value="KE"/>  
<xs:enumeration value="KG"/>  
<xs:enumeration value="KH"/>  
<xs:enumeration value="KI"/>  
<xs:enumeration value="KM"/>  
<xs:enumeration value="KN"/>  
<xs:enumeration value="KP"/>  
<xs:enumeration value="KR"/>  
<xs:enumeration value="KW"/>  
<xs:enumeration value="KY"/>  
<xs:enumeration value="KZ"/>  
<xs:enumeration value="LA"/>  
<xs:enumeration value="LB"/>  
<xs:enumeration value="LC"/>  
<xs:enumeration value="LI"/>  
<xs:enumeration value="LK"/>  
<xs:enumeration value="LR"/>  
<xs:enumeration value="LS"/>  
<xs:enumeration value="LT"/>
```

```
<xs:enumeration value="LU"/>  
<xs:enumeration value="LV"/>  
<xs:enumeration value="LY"/>  
<xs:enumeration value="MA"/>  
<xs:enumeration value="MC"/>  
<xs:enumeration value="MD"/>  
<xs:enumeration value="MG"/>  
<xs:enumeration value="MH"/>  
<xs:enumeration value="MK"/>  
<xs:enumeration value="ML"/>  
<xs:enumeration value="MM"/>  
<xs:enumeration value="MN"/>  
<xs:enumeration value="MO"/>  
<xs:enumeration value="MP"/>  
<xs:enumeration value="MQ"/>  
<xs:enumeration value="MR"/>  
<xs:enumeration value="MS"/>  
<xs:enumeration value="MT"/>  
<xs:enumeration value="MU"/>  
<xs:enumeration value="MV"/>  
<xs:enumeration value="MW"/>  
<xs:enumeration value="MX"/>  
<xs:enumeration value="MY"/>  
<xs:enumeration value="MZ"/>  
<xs:enumeration value="NA"/>  
<xs:enumeration value="NC"/>  
<xs:enumeration value="NE"/>  
<xs:enumeration value="NF"/>  
<xs:enumeration value="NG"/>  
<xs:enumeration value="NI"/>  
<xs:enumeration value="NL"/>  
<xs:enumeration value="NO"/>  
<xs:enumeration value="NP"/>  
<xs:enumeration value="NR"/>  
<xs:enumeration value="NU"/>  
<xs:enumeration value="NZ"/>  
<xs:enumeration value="OM"/>  
<xs:enumeration value="PA"/>  
<xs:enumeration value="PE"/>  
<xs:enumeration value="PF"/>  
<xs:enumeration value="PG"/>  
<xs:enumeration value="PH"/>  
<xs:enumeration value="PK"/>  
<xs:enumeration value="PL"/>  
<xs:enumeration value="PM"/>  
<xs:enumeration value="PN"/>  
<xs:enumeration value="PR"/>  
<xs:enumeration value="PS"/>  
<xs:enumeration value="PT"/>  
<xs:enumeration value="PW"/>  
<xs:enumeration value="PY"/>  
<xs:enumeration value="QA"/>  
<xs:enumeration value="RE"/>  
<xs:enumeration value="RO"/>  
<xs:enumeration value="RU"/>
```

```
<xs:enumeration value="RW"/>  
<xs:enumeration value="SA"/>  
<xs:enumeration value="SB"/>  
<xs:enumeration value="SC"/>  
<xs:enumeration value="SD"/>  
<xs:enumeration value="SE"/>  
<xs:enumeration value="SG"/>  
<xs:enumeration value="SH"/>  
<xs:enumeration value="SI"/>  
<xs:enumeration value="SJ"/>  
<xs:enumeration value="SK"/>  
<xs:enumeration value="SL"/>  
<xs:enumeration value="SM"/>  
<xs:enumeration value="SN"/>  
<xs:enumeration value="SO"/>  
<xs:enumeration value="SR"/>  
<xs:enumeration value="ST"/>  
<xs:enumeration value="SV"/>  
<xs:enumeration value="SY"/>  
<xs:enumeration value="SZ"/>  
<xs:enumeration value="TC"/>  
<xs:enumeration value="TD"/>  
<xs:enumeration value="TF"/>  
<xs:enumeration value="TG"/>  
<xs:enumeration value="TH"/>  
<xs:enumeration value="TJ"/>  
<xs:enumeration value="TK"/>  
<xs:enumeration value="TL"/>  
<xs:enumeration value="TM"/>  
<xs:enumeration value="TN"/>  
<xs:enumeration value="TO"/>  
<xs:enumeration value="TR"/>  
<xs:enumeration value="TT"/>  
<xs:enumeration value="TV"/>  
<xs:enumeration value="TW"/>  
<xs:enumeration value="TZ"/>  
<xs:enumeration value="UA"/>  
<xs:enumeration value="UG"/>  
<xs:enumeration value="UM"/>  
<xs:enumeration value="UY"/>  
<xs:enumeration value="UZ"/>  
<xs:enumeration value="VA"/>  
<xs:enumeration value="VC"/>  
<xs:enumeration value="VE"/>  
<xs:enumeration value="VG"/>  
<xs:enumeration value="VI"/>  
<xs:enumeration value="VN"/>  
<xs:enumeration value="VU"/>  
<xs:enumeration value="WF"/>  
<xs:enumeration value="WS"/>  
<xs:enumeration value="YE"/>  
<xs:enumeration value="YT"/>  
<xs:enumeration value="ZA"/>  
<xs:enumeration value="ZM"/>  
<xs:enumeration value="ZW"/>
```

```
<!-- United States -->  
<!-- Andorra -->  
<!-- United Arab Emirates -->  
<!-- Afghanistan -->  
<!-- Antigua And Barbuda -->  
<!-- Anguilla -->  
<!-- Albania -->  
<!-- Armenia -->  
<!-- Netherlands Antilles -->  
<!-- Angola -->  
<!-- Antarctica -->  
<!-- Argentina -->  
<!-- American Samoa -->  
<!-- Austria -->  
<!-- Australia -->  
<!-- Aruba -->  
<!-- Aland Islands -->  
<!-- Azerbaijan -->  
<!-- Bosnia And Herzegovina -->  
<!-- Barbados -->  
<!-- Bangladesh -->  
<!-- Belgium -->  
<!-- Burkina Faso -->  
<!-- Bulgaria -->  
<!-- Bahrain -->  
<!-- Burundi -->  
<!-- Benin -->  
<!-- Bermuda -->  
<!-- Brunei Darussalam -->  
<!-- Bolivia -->  
<!-- Brazil -->  
<!-- Bahamas -->  
<!-- Bhutan -->  
<!-- Bouvet Island -->  
<!-- Botswana -->  
<!-- Belarus -->  
<!-- Belize -->  
<!-- Canada -->  
<!-- Cocos (Keeling) Islands -->  
<!-- Congo -->  
<!-- Central African Republic -->  
<!-- Congo , The Democratic Republic Of The -->  
<!-- Switzerland -->  
<!-- Cote D'ivoire -->  
<!-- Cook Islands -->  
<!-- Chile -->  
<!-- Cameroon -->  
<!-- China -->  
<!-- Colombia -->  
<!-- Costa Rica -->  
<!-- Serbia And Montenegro -->  
<!-- Cuba -->  
<!-- Cape Verde -->  
<!-- Christmas Island -->  
<!-- Cyprus -->
```

<pre><!-- Czech Republic --> <!-- Germany --> <!-- Djibouti --> <!-- Denmark --> <!-- Dominica --> <!-- Dominican Republic --> <!-- Algeria --> <!-- Ecuador --> <!-- Estonia --> <!-- Egypt --> <!-- Western Sahara --> <!-- Eritrea --> <!-- Spain --> <!-- Ethiopia --> <!-- Finland --> <!-- Fiji --> <!-- Falkland Islands (Malvinas) --> <!-- Micronesia, Federated States Of --> <!-- Faroe Islands --> <!-- France --> <!-- Gabon --> <!-- United Kingdom --> <!-- Grenada --> <!-- Georgia --> <!-- French Guiana --> <!-- Ghana --> <!-- Gibraltar --> <!-- Greenland --> <!-- Gambia --> <!-- Guinea --> <!-- Guadeloupe --> <!-- Equatorial Guinea --> <!-- Greece --> <!-- South Georgia And The South Sandwich Islands --> <!-- Guatemala --> <!-- Guam --> <!-- Guinea - Bissau --> <!-- Guyana --> <!-- Hong Kong --> <!-- Heard Island and Mcdonald Islands --> <!-- Honduras --> <!-- Croatia --> <!-- Haiti --> <!-- Hungary --> <!-- Indonesia --> <!-- Ireland --> <!-- Israel --> <!-- India --> <!-- British Indian Ocean Territory --> <!-- Iraq --> <!-- Iran, Islamic Republic Of --> <!-- Iceland --> <!-- Italy --> <!-- Jamaica --> <!-- Jordan --></pre>
--

```
<!-- Japan -->  
<!-- Kenya -->  
<!-- Kyrgyzstan -->  
<!-- Cambodia -->  
<!-- Kiribati -->  
<!-- Comoros -->  
<!-- Saint Kitts And Nevis -->  
<!-- Korea, Democratic People's Republic Of -->  
<!-- Korea, Republic Of -->  
<!-- Kuwait -->  
<!-- Cayman Islands -->  
<!-- Kazakhstan -->  
<!-- Lao People's Democratic Republic -->  
<!-- Lebanon -->  
<!-- Saint Lucia -->  
<!-- Liechtenstein -->  
<!-- Sri Lanka -->  
<!-- Liberia -->  
<!-- Lesotho -->  
<!-- Lithuania -->  
<!-- Luxembourg -->  
<!-- Latvia -->  
<!-- Libyan Arab Jamahiriya -->  
<!-- Morocco -->  
<!-- Monaco -->  
<!-- Moldova, Republic Of -->  
<!-- Madagascar -->  
<!-- Marshall Islands -->  
<!-- Macedonia, The Former Yugoslav Republic Of -->  
<!-- Mali -->  
<!-- Myanmar -->  
<!-- Mongolia -->  
<!-- Macao -->  
<!-- Northern Mariana Islands -->  
<!-- Martinique -->  
<!-- Mauritania -->  
<!-- Montserrat -->  
<!-- Malta -->  
<!-- Mauritius -->  
<!-- Maldives -->  
<!-- Malawi -->  
<!-- Mexico -->  
<!-- Malaysia -->  
<!-- Mozambique -->  
<!-- Namibia -->  
<!-- New Caledonia -->  
<!-- Niger -->  
<!-- Norfolk Island -->  
<!-- Nigeria -->  
<!-- Nicaragua -->  
<!-- Netherlands -->  
<!-- Norway -->  
<!-- Nepal -->  
<!-- Nauru -->  
<!-- Niue -->
```

<pre><!-- New Zealand --> <!-- Oman --> <!-- Panama --> <!-- Peru --> <!-- French Polynesia --> <!-- Papua New Guinea --> <!-- Philippines --> <!-- Pakistan --> <!-- Poland --> <!-- Saint Pierre And Miquelon --> <!-- Pitcairn --> <!-- Puerto Rico --> <!-- Palestinian Territory, Occupied --> <!-- Portugal --> <!-- Palau --> <!-- Paraguay --> <!-- Qatar --> <!-- Reunion --> <!-- Romania --> <!-- Russian Federation --> <!-- Rwanda --> <!-- Saudi Arabia --> <!-- Solomon Islands --> <!-- Seychelles --> <!-- Sudan --> <!-- Sweden --> <!-- Singapore --> <!-- Saint Helena --> <!-- Slovenia --> <!-- Svalbard And Jan Mayen --> <!-- Slovakia --> <!-- Sierra Leone --> <!-- San Marino --> <!-- Senegal --> <!-- Somalia --> <!-- Suriname --> <!-- Sao Tome And Principe --> <!-- El Salvador --> <!-- Syrian Arab Republic --> <!-- Swaziland --> <!-- Turks And Caicos Islands --> <!-- Chad --> <!-- French Southern Territories --> <!-- Togo --> <!-- Thailand --> <!-- Tajikistan --> <!-- Tokelau --> <!-- Timor - Leste --> <!-- Turkmenistan --> <!-- Tunisia --> <!-- Tonga --> <!-- Turkey --> <!-- Trinidad And Tobago --> <!-- Tuvalu --> <!-- Taiwan, Province Of China --></pre>
--

	<pre> <!-- Tanzania, United Republic Of --> <!-- Ukraine --> <!-- Uganda --> <!-- United States Minor Outlying Islands --> <!-- Uruguay --> <!-- Uzbekistan --> <!-- Holy See (Vatican City State) --> <!-- Saint Vincent And The Grenadines --> <!-- Venezuela --> <!-- Virgin Islands, British --> <!-- Virgin Islands, U.S. --> <!-- Viet Nam --> <!-- Vanuatu --> <!-- Wallis And Futuna --> <!-- Samoa --> <!-- Yemen --> <!-- Mayotte --> <!-- South Africa --> <!-- Zambia --> <!-- Zimbabwe --> </xs:restriction> </xs:simpleType> </pre>
--	---

simpleType **CourseCreditType**

namespace	urn:us:tx:state:tea:TREx:v1.16									
type	restriction of xs:decimal									
properties	base xs:decimal									
used by	element CourseType/CourseCredit									
facets	<table border="1"> <thead> <tr> <th>Kind</th> <th>Value</th> <th>Annotation</th> </tr> </thead> <tbody> <tr> <td>totalDigits</td> <td>2</td> <td></td> </tr> <tr> <td>fractionDigits</td> <td>1</td> <td></td> </tr> </tbody> </table>	Kind	Value	Annotation	totalDigits	2		fractionDigits	1	
Kind	Value	Annotation								
totalDigits	2									
fractionDigits	1									
source	<pre> <xs:simpleType name="CourseCreditType"> <xs:restriction base="xs:decimal"> <xs:totalDigits value="2"/> <xs:fractionDigits value="1"/> </xs:restriction> </xs:simpleType> </pre>									

simpleType **CourseExplanationType**

namespace	urn:us:tx:state:tea:TREx:v1.16						
type	restriction of xs:token						
properties	base xs:token						
used by	element CourseType/Explanation						
facets	<table border="1"> <thead> <tr> <th>Kind</th> <th>Value</th> <th>Annotation</th> </tr> </thead> <tbody> <tr> <td>enumeration</td> <td>A</td> <td></td> </tr> </tbody> </table>	Kind	Value	Annotation	enumeration	A	
Kind	Value	Annotation					
enumeration	A						

	enumeration C enumeration D enumeration E enumeration G enumeration H enumeration I enumeration J enumeration K enumeration L enumeration M enumeration P enumeration Q enumeration R enumeration T enumeration V enumeration X enumeration Z enumeration 1 enumeration 2 enumeration 3 enumeration 4 enumeration 5 enumeration 7 enumeration 8 enumeration 9 enumeration 10
source	<pre> <xs:simpleType name="CourseExplanationType"> <xs:restriction base="xs:token"> <xs:enumeration value="A"/> <xs:enumeration value="C"/> <xs:enumeration value="D"/> <xs:enumeration value="E"/> <xs:enumeration value="G"/> <xs:enumeration value="H"/> <xs:enumeration value="I"/> <xs:enumeration value="J"/> <xs:enumeration value="K"/> <xs:enumeration value="L"/> <xs:enumeration value="M"/> <xs:enumeration value="P"/> <xs:enumeration value="Q"/> <xs:enumeration value="R"/> <xs:enumeration value="T"/> <xs:enumeration value="V"/> <xs:enumeration value="X"/> <xs:enumeration value="Z"/> <xs:enumeration value="1"/> <xs:enumeration value="2"/> <xs:enumeration value="3"/> </pre>

	<pre> <xs:enumeration value="4"/> <xs:enumeration value="5"/> <xs:enumeration value="7"/> <xs:enumeration value="8"/> <xs:enumeration value="9"/> <xs:enumeration value="10"/> <!-- A high school course for which college credit will be awarded by a college under the conditions of a local articulation agreement or the statewide Advanced Technical Credit Program agreement. Colleges agreeing to award credit under the conditions of a local agreement or under a Tech Prep program agreement must be named. --> <!-- A course taken by correspondence from an approved institution of higher education (19 TAC 74.23). --> <!-- A college course for taken dual credit (19 TAC 74.25). --> <!-- A course for which credit is awarded by examination in an academic subject in which the student has had no prior instruction (Credit by Exam) (TAC §74.24(c)(1)). --> <!-- A gifted/talented course. --> <!-- An honors course. (Note: This refers to locally-approved honors courses.) --> <!-- An International Baccalaureate course. --> <!-- A high school course completed prior to grade 9 (19 TAC 74.26). --> <!-- A pre-International Baccalaureate course. --> <!-- A local-credit course taken for local credit only. (Note: Local credit is not counted toward state graduation requirements unless the course is required by an ARD Committee for students receiving special education services who entered grade nine prior to the 2011-2012 school year.). --> <!-- A magnet course. --> <!-- A College Board Advanced Placement (AP) course. --> <!-- A pre-Advanced Placement course --> <!-- A course completed in summer school, night school, or other instructional arrangement outside the regular school year and/or day. --> <!-- A course for which credit is awarded by examination in an academic subject in which the student has had some prior formal instruction (TAC §74.24(c)(3)). --> <!-- A state-approved course in which content as described by the TEKS has been modified as a result of an ARD Committee decision. This code is used only for students receiving special education services to indicate modifications in TEKS course content. --> <!-- An innovative course approved for state graduation elective credit by the State Board of Education or the Commissioner of Education (19 TAC 74.27). -- > <!-- A course taken by distance learning including but not limited to the Texas Virtual School Network (TXVSN) television instruction, electronic transmission, or satellite broadcast (19 TAC 74.23) --> <!-- A course for which a physical education credit or waiver is awarded through a substitution allowed by 19 TAC 74. --> <!-- A course that is part of a coherent sequence of career and technical education (CTE) courses (19 TAC 74.3(b)(2)(G)). --> <!-- A course for which credit is awarded based on the district's evaluation of the student's records from a school that operates outside the Texas public or charter school system (i.e., home schools, private schools, out of state schools, etc.) (TAC 74.26(A)(2)) --> <!-- A Career & Technical Education course that satisfies a specific graduation requirement as allowed by 19 TAC 74. --> </pre>
--	--

	<pre> <!-- Course Grade Average or Final Grade Average includes STAAR EOC results --> <!-- A TEKS-based course that includes 100 minutes of moderate to vigorous physical activity per five-day school week taken to satisfy the physical education requirement on the Foundation High School Program (19 TAC 74.12(b)(6)(B)). --> <!-- A course other than a languages other than English (LOTE) course taken to satisfy the LOTE requirement on the Foundation High School Program (19 TAC 74.12(b)(5)(B) or (D)). --> <!-- A course taken by a student with written permission from the student's parent/guardian to satisfy the fourth science requirement for the arts and humanities endorsement on the Foundation High School Program (19 TAC 74.13(e)(5)(EE)). --> <!-- A course taken as a part of a Foundation High School Program endorsement. --> </xs:restriction> </xs:simpleType> </pre>
--	---

simpleType **CourseGradeType**

namespace	urn:us:tx:state:tea:TREx:v1.16									
type	restriction of xs:token									
properties	base xs:token									
used by	elements CourseType/CourseGrade CourseType/FinalGradeAverage CourseType/GradeAverage									
facets	<table border="1"> <thead> <tr> <th>Kind</th> <th>Value</th> <th>Annotation</th> </tr> </thead> <tbody> <tr> <td>minLength</td> <td>1</td> <td></td> </tr> <tr> <td>maxLength</td> <td>10</td> <td></td> </tr> </tbody> </table>	Kind	Value	Annotation	minLength	1		maxLength	10	
Kind	Value	Annotation								
minLength	1									
maxLength	10									
source	<pre> <xs:simpleType name="CourseGradeType"> <xs:restriction base="xs:token"> <xs:minLength value="1"/> <xs:maxLength value="10"/> </xs:restriction> </xs:simpleType> </pre>									

simpleType **CourseIDType**

namespace	urn:us:tx:state:tea:TREx:v1.16									
type	restriction of xs:token									
properties	base xs:token									
used by	element CourseType/CourseID									
facets	<table border="1"> <thead> <tr> <th>Kind</th> <th>Value</th> <th>Annotation</th> </tr> </thead> <tbody> <tr> <td>minLength</td> <td>1</td> <td></td> </tr> <tr> <td>maxLength</td> <td>64</td> <td></td> </tr> </tbody> </table>	Kind	Value	Annotation	minLength	1		maxLength	64	
Kind	Value	Annotation								
minLength	1									
maxLength	64									
source	<pre> <xs:simpleType name="CourseIDType"> <xs:restriction base="xs:token"> <xs:minLength value="1"/> <xs:maxLength value="64"/> </xs:restriction> </xs:simpleType> </pre>									

	<pre> </xs:restriction> </xs:simpleType> </pre>
--	---

simpleType **CourseTeacherType**

namespace	urn:us:tx:state:tea:TREx:v1.16									
type	restriction of xs:token									
properties	base xs:token									
used by	element CourseType/CourseTeacher									
facets	<table border="1"> <thead> <tr> <th>Kind</th> <th>Value</th> <th>Annotation</th> </tr> </thead> <tbody> <tr> <td>minLength</td> <td>1</td> <td></td> </tr> <tr> <td>maxLength</td> <td>40</td> <td></td> </tr> </tbody> </table>	Kind	Value	Annotation	minLength	1		maxLength	40	
Kind	Value	Annotation								
minLength	1									
maxLength	40									
source	<pre> <xs:simpleType name="CourseTeacherType"> <xs:restriction base="xs:token"> <xs:minLength value="1"/> <xs:maxLength value="40"/> </xs:restriction> </xs:simpleType> </pre>									

simpleType **CourseTitleType**

namespace	urn:us:tx:state:tea:TREx:v1.16									
type	restriction of xs:token									
properties	base xs:token									
used by	element CourseType/CourseTitle									
facets	<table border="1"> <thead> <tr> <th>Kind</th> <th>Value</th> <th>Annotation</th> </tr> </thead> <tbody> <tr> <td>minLength</td> <td>1</td> <td></td> </tr> <tr> <td>maxLength</td> <td>100</td> <td></td> </tr> </tbody> </table>	Kind	Value	Annotation	minLength	1		maxLength	100	
Kind	Value	Annotation								
minLength	1									
maxLength	100									
source	<pre> <xs:simpleType name="CourseTitleType"> <xs:restriction base="xs:token"> <xs:minLength value="1"/> <xs:maxLength value="100"/> </xs:restriction> </xs:simpleType> </pre>									

simpleType **DaysType**

namespace	urn:us:tx:state:tea:TREx:v1.16						
type	restriction of xs:decimal						
properties	base xs:decimal						
used by	elements AttendanceType/DaysAbsent AttendanceType/DaysAttended						
facets	<table border="1"> <thead> <tr> <th>Kind</th> <th>Value</th> <th>Annotation</th> </tr> </thead> <tbody> <tr> <td>totalDigits</td> <td>4</td> <td></td> </tr> </tbody> </table>	Kind	Value	Annotation	totalDigits	4	
Kind	Value	Annotation					
totalDigits	4						

	fractionDigits 1
source	<pre><xs:simpleType name="DaysType"> <xs:restriction base="xs:decimal"> <xs:totalDigits value="4"/> <xs:fractionDigits value="1"/> </xs:restriction> </xs:simpleType></pre>

simpleType **DisciplineActionCodeType**

namespace	urn:us:tx:state:tea:TREx:v1.16																																																																																													
type	restriction of xs:token																																																																																													
properties	base xs:token																																																																																													
used by	element DisciplineActionType/DisciplineActionCode																																																																																													
facets	<table border="1"> <thead> <tr> <th>Kind</th> <th>Value</th> <th>Annotation</th> </tr> </thead> <tbody> <tr><td>enumeration</td><td>01</td><td></td></tr> <tr><td>enumeration</td><td>02</td><td></td></tr> <tr><td>enumeration</td><td>03</td><td></td></tr> <tr><td>enumeration</td><td>04</td><td></td></tr> <tr><td>enumeration</td><td>05</td><td></td></tr> <tr><td>enumeration</td><td>06</td><td></td></tr> <tr><td>enumeration</td><td>07</td><td></td></tr> <tr><td>enumeration</td><td>08</td><td></td></tr> <tr><td>enumeration</td><td>09</td><td></td></tr> <tr><td>enumeration</td><td>10</td><td></td></tr> <tr><td>enumeration</td><td>11</td><td></td></tr> <tr><td>enumeration</td><td>12</td><td></td></tr> <tr><td>enumeration</td><td>13</td><td></td></tr> <tr><td>enumeration</td><td>14</td><td></td></tr> <tr><td>enumeration</td><td>15</td><td></td></tr> <tr><td>enumeration</td><td>25</td><td></td></tr> <tr><td>enumeration</td><td>26</td><td></td></tr> <tr><td>enumeration</td><td>27</td><td></td></tr> <tr><td>enumeration</td><td>28</td><td></td></tr> <tr><td>enumeration</td><td>50</td><td></td></tr> <tr><td>enumeration</td><td>51</td><td></td></tr> <tr><td>enumeration</td><td>52</td><td></td></tr> <tr><td>enumeration</td><td>53</td><td></td></tr> <tr><td>enumeration</td><td>54</td><td></td></tr> <tr><td>enumeration</td><td>55</td><td></td></tr> <tr><td>enumeration</td><td>56</td><td></td></tr> <tr><td>enumeration</td><td>57</td><td></td></tr> <tr><td>enumeration</td><td>58</td><td></td></tr> <tr><td>enumeration</td><td>59</td><td></td></tr> <tr><td>enumeration</td><td>60</td><td></td></tr> </tbody> </table>	Kind	Value	Annotation	enumeration	01		enumeration	02		enumeration	03		enumeration	04		enumeration	05		enumeration	06		enumeration	07		enumeration	08		enumeration	09		enumeration	10		enumeration	11		enumeration	12		enumeration	13		enumeration	14		enumeration	15		enumeration	25		enumeration	26		enumeration	27		enumeration	28		enumeration	50		enumeration	51		enumeration	52		enumeration	53		enumeration	54		enumeration	55		enumeration	56		enumeration	57		enumeration	58		enumeration	59		enumeration	60	
Kind	Value	Annotation																																																																																												
enumeration	01																																																																																													
enumeration	02																																																																																													
enumeration	03																																																																																													
enumeration	04																																																																																													
enumeration	05																																																																																													
enumeration	06																																																																																													
enumeration	07																																																																																													
enumeration	08																																																																																													
enumeration	09																																																																																													
enumeration	10																																																																																													
enumeration	11																																																																																													
enumeration	12																																																																																													
enumeration	13																																																																																													
enumeration	14																																																																																													
enumeration	15																																																																																													
enumeration	25																																																																																													
enumeration	26																																																																																													
enumeration	27																																																																																													
enumeration	28																																																																																													
enumeration	50																																																																																													
enumeration	51																																																																																													
enumeration	52																																																																																													
enumeration	53																																																																																													
enumeration	54																																																																																													
enumeration	55																																																																																													
enumeration	56																																																																																													
enumeration	57																																																																																													
enumeration	58																																																																																													
enumeration	59																																																																																													
enumeration	60																																																																																													

	enumeration 61
source	<pre> <xs:simpleType name="DisciplineActionCodeType"> <xs:restriction base="xs:token"> <xs:enumeration value="01"/> <xs:enumeration value="02"/> <xs:enumeration value="03"/> <xs:enumeration value="04"/> <xs:enumeration value="05"/> <xs:enumeration value="06"/> <xs:enumeration value="07"/> <xs:enumeration value="08"/> <xs:enumeration value="09"/> <xs:enumeration value="10"/> <xs:enumeration value="11"/> <xs:enumeration value="12"/> <xs:enumeration value="13"/> <xs:enumeration value="14"/> <xs:enumeration value="15"/> <xs:enumeration value="25"/> <xs:enumeration value="26"/> <xs:enumeration value="27"/> <xs:enumeration value="28"/> <xs:enumeration value="50"/> <xs:enumeration value="51"/> <xs:enumeration value="52"/> <xs:enumeration value="53"/> <xs:enumeration value="54"/> <xs:enumeration value="55"/> <xs:enumeration value="56"/> <xs:enumeration value="57"/> <xs:enumeration value="58"/> <xs:enumeration value="59"/> <xs:enumeration value="60"/> <xs:enumeration value="61"/> <!-- Expulsion (TEC 37.007) without placement in another educational setting as a result of a formal expulsion hearing [TEC 37.009(f)]. (This code does not apply if a student continues to receive educational services during the term of expulsion.) --> <!-- Expulsion (TEC 37.007) with placement in a juvenile justice alternative education program (JJAEP) as a result of a formal expulsion hearing [TEC 37.009(f)]. --> <!-- Expulsion (TEC 37.007) with placement in an on-campus disciplinary alternative education program (DAEP) as a result of a formal expulsion hearing [TEC 37.009(f)]. (Do not use this code when a student has been placed in a DAEP, but not expelled.) --> <!-- Expulsion (TEC 37.007) with placement in an off-campus DAEP as a result of a formal expulsion hearing [TEC 37.009(f)]. (Do not use this code when a student has been placed in a DAEP, but not expelled.) --> <!-- Out-of-school suspension (Suspension may not exceed three days under TEC 37.005.) --> <!-- In-school suspension (For students eligible for special education and related services, this includes any setting that has not been addressed by an admission, review, and dismissal committee within the placement determination of the student's current IEP.) (Suspension may not exceed three days under TEC </pre>

<pre>37.005.) --> <!-- Placement in an on-campus or off-campus DAEP (TEC 37.008) as a result of a conference [TEC 37.009(a)], rather than a formal hearing as required for expulsion. --> <!-- Continuation of other district's DAEP placement --> <!-- Continuation of other district's expulsion order --> <!-- Continuation of the district's DAEP placement from the prior school year --> <!-- Continuation of the district's expulsion order from the prior school year --> <!-- Continuation of the district's expulsion with placement to JJAEP from the prior school year --> <!-- Placement in a JJAEP by Court order --> <!-- Placement in a DAEP by Court order --> <!-- Continuation of other district's expulsion with placement to JJAEP --> <!-- Partial day Out-of-School Suspension --> <!-- Partial day In-School Suspension --> <!-- Mandatory disciplinary action not taken by district as a result of ARD committee manifestation hearing determination, made in accordance with IDEA for a student receiving special education services, that the student's behavior is linked to the student's disability. --> <!-- Mandatory disciplinary action not taken - (TEC 37.001(a)(4) - The mandatory disciplinary action was not taken because the district's Student Code of Conduct includes one or more of the TEC, 37.001(a)(4) provisions that allows the district to consider self defense, intent or lack of intent, student's disciplinary history, or disability that substantially impairs the student's capacity to appreciate the wrongfulness of the student's conduct as a factor in a decision to order suspension, removal to a disciplinary alternative education program, or expulsion. --> <!-- Expulsion without placement in another educational setting as a result of a determination by a special education hearing officer (not a hearing officer employed or appointed by the district) --> <!-- Expulsion with placement to a JJAEP as a result of a determination by a special education hearing officer (not a hearing officer employed or appointed by the district) --> <!-- Expulsion with placement to an on-campus DAEP as a result of a determination by a special education hearing officer --> <!-- Expulsion with placement to an off-campus DAEP as a result of a determination by a special education hearing officer --> <!-- Placement in an alternative education program established under TEC, 37.008 as a result of a determination by a special education hearing officer --> <!-- Continuation of other district's DAEP placement as a result by a special education determination of a hearing officer --> <!-- Continuation of other district's expulsion order as a result by a special education determination of a hearing officer --> <!-- Continuation of the district's DAEP placement from the prior school year as a result of a determination by a special education hearing officer --> <!-- Continuation of the district's expulsion order from the prior school year as a result of a determination by a special education hearing officer --> <!-- Continuation of the district's expulsion with placement to JJAEP from the prior school year as a result of a determination by a special education hearing officer --> <!-- Placement in a JJAEP as a result of a determination by a special education hearing officer --> <!-- Continuation of other district's expulsion with placement to JJAEP as a</pre>

	<pre> result of a determination by a special education hearing officer --> </xs:restriction> </xs:simpleType> </pre>
--	---

simpleType **DisciplineActionNumType**

namespace	urn:us:tx:state:tea:TREx:v1.16						
type	restriction of xs:integer						
properties	base xs:integer						
used by	element DisciplineActionType/DisciplineActionNum						
facets	<table border="1"> <thead> <tr> <th>Kind</th> <th>Value</th> <th>Annotation</th> </tr> </thead> <tbody> <tr> <td>totalDigits</td> <td>3</td> <td></td> </tr> </tbody> </table>	Kind	Value	Annotation	totalDigits	3	
Kind	Value	Annotation					
totalDigits	3						
source	<pre> <xs:simpleType name="DisciplineActionNumType"> <xs:restriction base="xs:integer"> <xs:totalDigits value="3"/> </xs:restriction> </xs:simpleType> </pre>						

simpleType **DisciplineActionReasonType**

namespace	urn:us:tx:state:tea:TREx:v1.16																																																												
type	restriction of xs:token																																																												
properties	base xs:token																																																												
used by	element DisciplineActionType/DisciplineActionReason																																																												
facets	<table border="1"> <thead> <tr> <th>Kind</th> <th>Value</th> <th>Annotation</th> </tr> </thead> <tbody> <tr><td>enumeration</td><td>01</td><td></td></tr> <tr><td>enumeration</td><td>02</td><td></td></tr> <tr><td>enumeration</td><td>04</td><td></td></tr> <tr><td>enumeration</td><td>05</td><td></td></tr> <tr><td>enumeration</td><td>06</td><td></td></tr> <tr><td>enumeration</td><td>07</td><td></td></tr> <tr><td>enumeration</td><td>08</td><td></td></tr> <tr><td>enumeration</td><td>09</td><td></td></tr> <tr><td>enumeration</td><td>10</td><td></td></tr> <tr><td>enumeration</td><td>11</td><td></td></tr> <tr><td>enumeration</td><td>12</td><td></td></tr> <tr><td>enumeration</td><td>13</td><td></td></tr> <tr><td>enumeration</td><td>14</td><td></td></tr> <tr><td>enumeration</td><td>16</td><td></td></tr> <tr><td>enumeration</td><td>17</td><td></td></tr> <tr><td>enumeration</td><td>18</td><td></td></tr> <tr><td>enumeration</td><td>19</td><td></td></tr> <tr><td>enumeration</td><td>20</td><td></td></tr> <tr><td>enumeration</td><td>21</td><td></td></tr> </tbody> </table>	Kind	Value	Annotation	enumeration	01		enumeration	02		enumeration	04		enumeration	05		enumeration	06		enumeration	07		enumeration	08		enumeration	09		enumeration	10		enumeration	11		enumeration	12		enumeration	13		enumeration	14		enumeration	16		enumeration	17		enumeration	18		enumeration	19		enumeration	20		enumeration	21	
Kind	Value	Annotation																																																											
enumeration	01																																																												
enumeration	02																																																												
enumeration	04																																																												
enumeration	05																																																												
enumeration	06																																																												
enumeration	07																																																												
enumeration	08																																																												
enumeration	09																																																												
enumeration	10																																																												
enumeration	11																																																												
enumeration	12																																																												
enumeration	13																																																												
enumeration	14																																																												
enumeration	16																																																												
enumeration	17																																																												
enumeration	18																																																												
enumeration	19																																																												
enumeration	20																																																												
enumeration	21																																																												

	enumeration 22 enumeration 23 enumeration 26 enumeration 27 enumeration 28 enumeration 29 enumeration 30 enumeration 31 enumeration 32 enumeration 33 enumeration 34 enumeration 35 enumeration 36 enumeration 37 enumeration 41 enumeration 46 enumeration 47 enumeration 48 enumeration 49 enumeration 50 documentation Deprecated enumeration 51 enumeration 52 enumeration 53 enumeration 54 enumeration 55 enumeration 56 enumeration 57 enumeration 58 enumeration 59
source	<pre> <xs:simpleType name="DisciplineActionReasonType"> <xs:restriction base="xs:token"> <xs:enumeration value="01"/> <xs:enumeration value="02"/> <xs:enumeration value="04"/> <xs:enumeration value="05"/> <xs:enumeration value="06"/> <xs:enumeration value="07"/> <xs:enumeration value="08"/> <xs:enumeration value="09"/> <xs:enumeration value="10"/> <xs:enumeration value="11"/> <xs:enumeration value="12"/> <xs:enumeration value="13"/> <xs:enumeration value="14"/> <xs:enumeration value="16"/> <xs:enumeration value="17"/> <xs:enumeration value="18"/> <xs:enumeration value="19"/> </pre>

```

<xs:enumeration value="20"/>
<xs:enumeration value="21"/>
<xs:enumeration value="22"/>
<xs:enumeration value="23"/>
<xs:enumeration value="26"/>
<xs:enumeration value="27"/>
<xs:enumeration value="28"/>
<xs:enumeration value="29"/>
<xs:enumeration value="30"/>
<xs:enumeration value="31"/>
<xs:enumeration value="32"/>
<xs:enumeration value="33"/>
<xs:enumeration value="34"/>
<xs:enumeration value="35"/>
<xs:enumeration value="36"/>
<xs:enumeration value="37"/>
<xs:enumeration value="41"/>
<xs:enumeration value="46"/>
<xs:enumeration value="47"/>
<xs:enumeration value="48"/>
<xs:enumeration value="49"/>
<xs:enumeration value="50">
  <xs:annotation>
    <xs:documentation>Deprecated</xs:documentation>
  </xs:annotation>
  <!-- Used, exhibited, or possessed a non-illegal knife as defined by
student code of conduct and as allowed under TEC 37.007. (Knife blade equal to
or less than 5.5 inches.) -->
</xs:enumeration>
<xs:enumeration value="51"/>
<xs:enumeration value="52"/>
<xs:enumeration value="53"/>
<xs:enumeration value="54"/>
<xs:enumeration value="55"/>
<xs:enumeration value="56"/>
<xs:enumeration value="57"/>
<xs:enumeration value="58"/>
<xs:enumeration value="59"/>
  <!-- Permanent Removal by a Teacher from Class (Teacher has removed the
student from classroom and denied the student the right to return. TEC 37.003
has been invoked.) -->
  <!-- Conduct punishable as a felony - TEC 37.006(a)(2)(A) -->
  <!-- Possessed, sold, used, or was under the influence of marihuana or other
controlled substance TEC 37.006(a)(2)(C) and 37.007(b) -->
  <!-- Possessed, sold, used, or was under the influence of an alcoholic
beverage -->
  <!-- Abuse of a volatile chemical - TEC 37.006(a)(2)(E) -->
  <!-- Public lewdness or indecent exposure - TEC 37.006(a)(2)(F) -->
  <!-- Retaliation against school employee - TEC 37.006(b) and 37.007(d) -->
  <!-- Based on conduct occurring off campus and while the student is not in
attendance at a school-sponsored or school-related activity for felony offenses
in Title 5, Penal Code - TEC 37.006(c), TEC 37.007(b)(4), and TEC 37.0081. -->
  <!-- Based on conduct occurring off campus and while the student is not in
attendance at a school-sponsored or school-related activity for felony offenses
not in Title 5, Penal Code -->

```

<pre> <!-- Brought a Firearm to School - TEC 37.007(e) or Unlawful Carrying of a Handgun under Penal Code 46.02 - TEC 37.007(a)(1) --> <!-- Unlawful Carrying of an Illegal Knife under Penal Code 46.02 - TEC 37.007(a)(1) (Illegal knife - blade longer than 5.5 inches) --> <!-- Unlawful Carrying of a Club under Penal Code 46.02 - TEC 37.007(a)(1) - -> <!-- Conduct Containing the Elements of an Offense Relating to Prohibited Weapons Under Penal Code 46.05 - TEC 37.007(a)(1) --> <!-- Arson - TEC 37.007(a)(2)(B) --> <!-- Murder, capital murder, criminal attempt to commit murder, or capital murder - --> <!-- Indecency with a child - TEC 37.007(a)(2)(D) --> <!-- Aggravated kidnapping - TEC 37.007(a)(2)(E) --> <!-- Serious or persistent misconduct violating the student code of conduct while placed in a disciplinary alternative education program - TEC 37.007(c) --> <!-- Violation of student code of conduct not included under TEC 37.002(b), 37.006 or 37.007 (does not include student code of conduct violations covered in codes 33 and 34) --> <!-- Criminal mischief - TEC 37.007(f) --> <!-- Emergency Placement/expulsion - TEC 37.019 --> <!-- Terroristic threat - TEC 37.006(a)(1) and TEC 37.007(b) --> <!-- Assault under Penal Code 22.01(a)(1) against a school district employee or volunteer - --> <!-- Assault under Penal Code 22.01(a)(1) against someone other than a school district employee or volunteer - TEC 37.006(a)(2)(B) --> <!-- Aggravated assault under Penal Code 22.02 against a school district employee or volunteer-TEC 37.007(d) --> <!-- Aggravated assault under Penal Code 22.02 against someone other than a school district employee or volunteer - TEC 37.007 (a)(2)(A) --> <!-- Sexual assault under Penal Code 22.011 or aggravated sexual assault under Penal Code 22.021 against a school district employee or volunteer - TEC 37.007(d) --> <!-- Sexual assault under Penal Code 22.011 or aggravated sexual assault under Penal Code 22.021 against someone other than a school district employee or volunteer - --> <!-- Possessed, purchased, used, or accepted a cigarette or tobacco product as defined in the Health and Safety Code, Section 3.01, Chapter 161.252 --> <!-- School-related gang violence-Action by three or more persons having a common identifying sign or symbol or an identifiable sign/symbol or an identifiable leadership who associate in the commission of criminal activities under Penal Code 71.01 --> <!-- False alarm/false report - TEC 37.006(a)(1) and 37.007(b) --> <!-- Felony controlled substance violation - TEC 37.007(a)(3) --> <!-- Felony alcohol violation - TEC 37.007(a)(3) --> <!-- Fighting/Mutual Combat - Excludes all offenses under Penal Code 22.01 - -> <!-- Aggravated robbery - TEC 37.007(a)(2)(F), TEC 37.006 (C)-(D) --> <!-- Manslaughter - TEC 37.007(a)(2)(G) --> <!-- Criminally negligent homicide TEC 37.007(a)(2)(H) --> <!-- Engages in deadly conduct - TEC 37.007(b)(3) --> <!-- Firearm (Off Campus 300 ft. Zone) Used, exhibited or possessed a firearm specified in TEC 37.007(a)(1)(A) [as defined by 18 USC Section 921 or Penal Code 46.01(3)] off-campus but within 300 feet of school property as specified in TEC 37.007(b)(3). --> <!-- Illegal Knife, Club, or Prohibited Weapon (Off Campus 300 ft. Zone) </pre>
--

	<p>Used, exhibited or possessed an illegal knife, club, or prohibited weapon specified in TEC 37.007(a)(1)(B-D) off campus but within 300 feet of school property as specified in TEC 37.007(b)(3). --></p> <p><!-- Serious Offense Conduct (Off Campus 300 ft. Zone) Engaged in conduct that contains the elements of the offenses specified by TEC 37.007(a)(2)(A-H) occurring off-campus but within 300 feet of school property. This includes criminal conduct specified in TEC 37.007(b)(3) of aggravated assault, sexual assault, aggravated sexual assault, arson, murder, capital murder, criminal attempted murder or capital murder, indecency with a child, aggravated kidnapping, aggravated robbery, manslaughter, or criminally negligent homicide. --></p> <p><!-- Felony Marihuana, Controlled Substance, Dangerous Drug, or Alcoholic Beverage (Off Campus 300 ft. Zone) Engages in conduct punishable as a felony as specified by TEC 37.006(a)(2)(C) or (D) of selling, giving, or delivering to another person, or the possession, or use, or being under the influence of: marihuana, a controlled substance, a dangerous drug, or alcoholic beverage; or committing a serious offense while under the influence of alcohol, off-campus but within 300 feet of school property. --></p> <p><!-- Student is required to register as a sex offender under Chapter 62 of the Code of Criminal Procedure and is under court supervision - TEC 37.304. The offense(s) for which the student is required to register as a sex offender must have occurred on or after Sept. 1, 2007. --></p> <p><!-- Student is required to register as a sex offender under Chapter 62 of the Code of Criminal Procedure and is not under court supervision - TEC 37.305. The offense(s) for which the student is required to register as a sex offender must have occurred on or after Sept. 1, 2007. --></p> <p><!-- Continuous sexual abuse of young child or children under Penal Code 21.02, occurring on school property or while attending a school-sponsored or school-related activity on or off school property - TEC 37.007(a)(2)(I). --></p> <p><!-- Breach of Computer Security - TEC 37.007 (a) (5) --></p> <p><!-- Serious Misbehavior, as defined by TEC 37.007(c), while expelled to/placed in a DAEP --></p> <p></xs:restriction></p> <p></xs:simpleType></p>
--	--

simpleType **DistrictIDType**

namespace	urn:us:tx:state:tea:TReX:v1.16						
type	restriction of xs:token						
properties	base xs:token						
used by	element SchoolType/DistrictID						
facets	<table border="1"> <thead> <tr> <th>Kind</th> <th>Value</th> <th>Annotation</th> </tr> </thead> <tbody> <tr> <td>pattern</td> <td>([0-9]{6})</td> <td></td> </tr> </tbody> </table>	Kind	Value	Annotation	pattern	([0-9]{6})	
Kind	Value	Annotation					
pattern	([0-9]{6})						
source	<pre><xs:simpleType name="DistrictIDType"> <xs:restriction base="xs:token"> <xs:pattern value="([0-9]{6})"/> </xs:restriction> </xs:simpleType></pre>						

simpleType **DistrictNameType**

namespace	urn:us:tx:state:tea:TREx:v1.16									
type	restriction of xs:token									
properties	base xs:token									
used by	element SchoolType/DistrictName									
facets	<table border="1"> <thead> <tr> <th>Kind</th> <th>Value</th> <th>Annotation</th> </tr> </thead> <tbody> <tr> <td>minLength</td> <td>1</td> <td></td> </tr> <tr> <td>maxLength</td> <td>34</td> <td></td> </tr> </tbody> </table>	Kind	Value	Annotation	minLength	1		maxLength	34	
Kind	Value	Annotation								
minLength	1									
maxLength	34									
source	<pre><xs:simpleType name="DistrictNameType"> <xs:restriction base="xs:token"> <xs:minLength value="1"/> <xs:maxLength value="34"/> </xs:restriction> </xs:simpleType></pre>									

simpleType **EconomicDisadvantagedType**

namespace	urn:us:tx:state:tea:TREx:v1.16															
type	restriction of xs:token															
properties	base xs:token															
used by	element SpecialProgramsType/EconomicDisadvantaged															
facets	<table border="1"> <thead> <tr> <th>Kind</th> <th>Value</th> <th>Annotation</th> </tr> </thead> <tbody> <tr> <td>enumeration</td> <td>00</td> <td></td> </tr> <tr> <td>enumeration</td> <td>01</td> <td></td> </tr> <tr> <td>enumeration</td> <td>02</td> <td></td> </tr> <tr> <td>enumeration</td> <td>99</td> <td></td> </tr> </tbody> </table>	Kind	Value	Annotation	enumeration	00		enumeration	01		enumeration	02		enumeration	99	
Kind	Value	Annotation														
enumeration	00															
enumeration	01															
enumeration	02															
enumeration	99															
source	<pre><xs:simpleType name="EconomicDisadvantagedType"> <xs:restriction base="xs:token"> <xs:enumeration value="00"/> <xs:enumeration value="01"/> <xs:enumeration value="02"/> <xs:enumeration value="99"/> <!-- Not identified as economically disadvantaged. --> <!-- Eligible for free meals under the National School Lunch and Child Nutrition Program. --> <!-- Eligible for reduced-price meals under the National School Lunch and Child Nutrition Program. --> <!-- Other economic disadvantage --> </xs:restriction> </xs:simpleType></pre>															

simpleType **ESLType**

namespace	urn:us:tx:state:tea:TREx:v1.16
type	restriction of xs:token

properties	base xs:token															
used by	element SpecialProgramsType/ESL															
facets	<table border="1"> <thead> <tr> <th>Kind</th> <th>Value</th> <th>Annotation</th> </tr> </thead> <tbody> <tr> <td>enumeration</td> <td>0</td> <td></td> </tr> <tr> <td>enumeration</td> <td>1</td> <td></td> </tr> <tr> <td>enumeration</td> <td>2</td> <td></td> </tr> <tr> <td>enumeration</td> <td>3</td> <td></td> </tr> </tbody> </table>	Kind	Value	Annotation	enumeration	0		enumeration	1		enumeration	2		enumeration	3	
Kind	Value	Annotation														
enumeration	0															
enumeration	1															
enumeration	2															
enumeration	3															
source	<pre><xs:simpleType name="ESLType"> <xs:restriction base="xs:token"> <xs:enumeration value="0"/> <xs:enumeration value="1"/> <xs:enumeration value="2"/> <xs:enumeration value="3"/> <!-- Not receiving services, or condition or situation not applicable to this person or campus. --> <!-- Participant in program or service, or condition or situation applicable to this person or campus. --> <!-- English as a second language/content-based. --> <!-- English as a second language/pull-out. --> </xs:restriction> </xs:simpleType></pre>															

simpleType **EthnicityYesNoType**

namespace	urn:us:tx:state:tea:TREx:v1.16									
type	restriction of xs:token									
properties	base xs:token									
used by	elements EthnicityType/AmericanIndianAlaskaNativeCode EthnicityType/AsianCode EthnicityType/BlackAfricanAmericanCode EthnicityType/HispanicLatinoCode EthnicityType/NativeHawaiianPacificIslanderCode EthnicityType/WhiteCode									
facets	<table border="1"> <thead> <tr> <th>Kind</th> <th>Value</th> <th>Annotation</th> </tr> </thead> <tbody> <tr> <td>enumeration</td> <td>0</td> <td></td> </tr> <tr> <td>enumeration</td> <td>1</td> <td></td> </tr> </tbody> </table>	Kind	Value	Annotation	enumeration	0		enumeration	1	
Kind	Value	Annotation								
enumeration	0									
enumeration	1									
source	<pre><xs:simpleType name="EthnicityYesNoType"> <xs:restriction base="xs:token"> <xs:enumeration value="0"/> <xs:enumeration value="1"/> <!-- No, not part of this ethnicity --> <!-- Yes, part of this ethnicity --> </xs:restriction> </xs:simpleType></pre>									

simpleType **FHSP**

namespace	urn:us:tx:state:tea:TREx:v1.16
type	restriction of xs:token
properties	base xs:token

used by	elements AcademicStatusType/ArtsEndorsementCode AcademicStatusType/BusinessEndorsementCode AcademicStatusType/FHSPDistingIndicatorCode AcademicStatusType/FHSPParticipationCode AcademicStatusType/MultiStudiesEndorsementCode AcademicStatusType/PublicServicesEndorsementCode AcademicStatusType/STEMEndorsementCode												
facets	<table border="1"> <thead> <tr> <th>Kind</th> <th>Value</th> <th>Annotation</th> </tr> </thead> <tbody> <tr> <td>enumeration</td> <td>0</td> <td></td> </tr> <tr> <td>enumeration</td> <td>1</td> <td></td> </tr> <tr> <td>enumeration</td> <td>2</td> <td></td> </tr> </tbody> </table>	Kind	Value	Annotation	enumeration	0		enumeration	1		enumeration	2	
Kind	Value	Annotation											
enumeration	0												
enumeration	1												
enumeration	2												
source	<pre><xs:simpleType name="FHSP"> <xs:restriction base="xs:token"> <xs:enumeration value="0"/> <xs:enumeration value="1"/> <xs:enumeration value="2"/> <!-- Student is not pursuing or participating --> <!-- Student is Pursuing --> <!-- Student has Completed --> </xs:restriction> </xs:simpleType></pre>												

simpleType **FirstNameType**

namespace	urn:us:tx:state:tea:TREx:v1.16									
type	restriction of xs:token									
properties	base xs:token									
used by	element PersonNameType/FirstName									
facets	<table border="1"> <thead> <tr> <th>Kind</th> <th>Value</th> <th>Annotation</th> </tr> </thead> <tbody> <tr> <td>minLength</td> <td>1</td> <td></td> </tr> <tr> <td>maxLength</td> <td>30</td> <td></td> </tr> </tbody> </table>	Kind	Value	Annotation	minLength	1		maxLength	30	
Kind	Value	Annotation								
minLength	1									
maxLength	30									
source	<pre><xs:simpleType name="FirstNameType"> <xs:restriction base="xs:token"> <xs:minLength value="1"/> <xs:maxLength value="30"/> </xs:restriction> </xs:simpleType></pre>									

simpleType **FosterCareType**

namespace	urn:us:tx:state:tea:TREx:v1.16												
type	restriction of xs:token												
properties	base xs:token												
used by	element StudentDemographicType/FosterCare												
facets	<table border="1"> <thead> <tr> <th>Kind</th> <th>Value</th> <th>Annotation</th> </tr> </thead> <tbody> <tr> <td>enumeration</td> <td>0</td> <td></td> </tr> <tr> <td>enumeration</td> <td>1</td> <td></td> </tr> <tr> <td>enumeration</td> <td>2</td> <td></td> </tr> </tbody> </table>	Kind	Value	Annotation	enumeration	0		enumeration	1		enumeration	2	
Kind	Value	Annotation											
enumeration	0												
enumeration	1												
enumeration	2												
source	<pre><xs:simpleType name="FosterCareType"></pre>												

	<pre> <xs:restriction base="xs:token"> <xs:enumeration value="0"/> <xs:enumeration value="1"/> <xs:enumeration value="2"/> <!-- Student has never been in the conservatorship of the Dept. of Family and Protective Services. --> <!-- Student is currently in the conservatorship of the Department of Family and Protective Services. --> <!-- Pre-K student previously in the conservatorship of the DFPS following an adversary hearing. --> </xs:restriction> </xs:simpleType> </pre>
--	--

simpleType **GenderType**

namespace	urn:us:tx:state:tea:TREx:v1.16									
type	restriction of xs:token									
properties	base xs:token									
used by	element StudentDemographicType/Gender									
facets	<table border="1"> <thead> <tr> <th>Kind</th> <th>Value</th> <th>Annotation</th> </tr> </thead> <tbody> <tr> <td>enumeration</td> <td>F</td> <td></td> </tr> <tr> <td>enumeration</td> <td>M</td> <td></td> </tr> </tbody> </table>	Kind	Value	Annotation	enumeration	F		enumeration	M	
Kind	Value	Annotation								
enumeration	F									
enumeration	M									
source	<pre> <xs:simpleType name="GenderType"> <xs:restriction base="xs:token"> <xs:enumeration value="F"/> <xs:enumeration value="M"/> <!-- Female --> <!-- Male --> </xs:restriction> </xs:simpleType> </pre>									

simpleType **GiftedTalentedType**

namespace	urn:us:tx:state:tea:TREx:v1.16												
type	restriction of xs:token												
properties	base xs:token												
used by	element SpecialProgramsType/GiftedTalented												
facets	<table border="1"> <thead> <tr> <th>Kind</th> <th>Value</th> <th>Annotation</th> </tr> </thead> <tbody> <tr> <td>enumeration</td> <td>0</td> <td></td> </tr> <tr> <td>enumeration</td> <td>1</td> <td></td> </tr> <tr> <td>enumeration</td> <td>2</td> <td></td> </tr> </tbody> </table>	Kind	Value	Annotation	enumeration	0		enumeration	1		enumeration	2	
Kind	Value	Annotation											
enumeration	0												
enumeration	1												
enumeration	2												
source	<pre> <xs:simpleType name="GiftedTalentedType"> <xs:restriction base="xs:token"> <xs:enumeration value="0"/> <xs:enumeration value="1"/> <xs:enumeration value="2"/> <!-- Not receiving services. --> </xs:restriction> </xs:simpleType> </pre>												

	<pre> <!-- Participant in program or service. --> <!-- Furloughed from Gifted and Talented program; student identified but not participating in GT program. --> </xs:restriction> </xs:simpleType> </pre>
--	---

simpleType **GPAType**

namespace	urn:us:tx:state:tea:TREx:v1.16									
type	restriction of xs:token									
properties	base xs:token									
used by	element AcademicSummaryType/GPA									
facets	<table border="1"> <thead> <tr> <th>Kind</th> <th>Value</th> <th>Annotation</th> </tr> </thead> <tbody> <tr> <td>minLength</td> <td>1</td> <td></td> </tr> <tr> <td>maxLength</td> <td>10</td> <td></td> </tr> </tbody> </table>	Kind	Value	Annotation	minLength	1		maxLength	10	
Kind	Value	Annotation								
minLength	1									
maxLength	10									
source	<pre> <xs:simpleType name="GPAType"> <xs:restriction base="xs:token"> <xs:minLength value="1"/> <xs:maxLength value="10"/> </xs:restriction> </xs:simpleType> </pre>									

simpleType **GradeLevelType**

namespace	urn:us:tx:state:tea:TREx:v1.16																																													
type	restriction of xs:token																																													
properties	base xs:token																																													
used by	elements AcademicSessionType/GradeLevel CurrentCourseworkType/GradeLevel EnrollmentType/GradeLevel EnrollmentType/GradePlaced EnrollmentType/GradePromoted EnrollmentType/GradeRetained AssessmentType/TestLevel																																													
facets	<table border="1"> <thead> <tr> <th>Kind</th> <th>Value</th> <th>Annotation</th> </tr> </thead> <tbody> <tr><td>enumeration</td><td>EE</td><td></td></tr> <tr><td>enumeration</td><td>PK</td><td></td></tr> <tr><td>enumeration</td><td>KG</td><td></td></tr> <tr><td>enumeration</td><td>01</td><td></td></tr> <tr><td>enumeration</td><td>02</td><td></td></tr> <tr><td>enumeration</td><td>03</td><td></td></tr> <tr><td>enumeration</td><td>04</td><td></td></tr> <tr><td>enumeration</td><td>05</td><td></td></tr> <tr><td>enumeration</td><td>06</td><td></td></tr> <tr><td>enumeration</td><td>07</td><td></td></tr> <tr><td>enumeration</td><td>08</td><td></td></tr> <tr><td>enumeration</td><td>09</td><td></td></tr> <tr><td>enumeration</td><td>10</td><td></td></tr> <tr><td>enumeration</td><td>11</td><td></td></tr> </tbody> </table>	Kind	Value	Annotation	enumeration	EE		enumeration	PK		enumeration	KG		enumeration	01		enumeration	02		enumeration	03		enumeration	04		enumeration	05		enumeration	06		enumeration	07		enumeration	08		enumeration	09		enumeration	10		enumeration	11	
Kind	Value	Annotation																																												
enumeration	EE																																													
enumeration	PK																																													
enumeration	KG																																													
enumeration	01																																													
enumeration	02																																													
enumeration	03																																													
enumeration	04																																													
enumeration	05																																													
enumeration	06																																													
enumeration	07																																													
enumeration	08																																													
enumeration	09																																													
enumeration	10																																													
enumeration	11																																													

	enumeration 12
source	<pre> <xs:simpleType name="GradeLevelType"> <xs:restriction base="xs:token"> <xs:enumeration value="EE"/> <xs:enumeration value="PK"/> <xs:enumeration value="KG"/> <xs:enumeration value="01"/> <xs:enumeration value="02"/> <xs:enumeration value="03"/> <xs:enumeration value="04"/> <xs:enumeration value="05"/> <xs:enumeration value="06"/> <xs:enumeration value="07"/> <xs:enumeration value="08"/> <xs:enumeration value="09"/> <xs:enumeration value="10"/> <xs:enumeration value="11"/> <xs:enumeration value="12"/> <!-- Early Education --> <!-- Pre-Kindergarten --> <!-- Kindergarten --> <!-- Grade 1 --> <!-- Grade 2 --> <!-- Grade 3 --> <!-- Grade 4 --> <!-- Grade 5 --> <!-- Grade 6 --> <!-- Grade 7 --> <!-- Grade 8 --> <!-- Grade 9 --> <!-- Grade 10 --> <!-- Grade 11 --> <!-- Grade 12 --> </xs:restriction> </xs:simpleType> </pre>

simpleType **GraduationDiplomaType**

namespace	urn:us:tx:state:tea:TReX:v1.16																								
type	restriction of xs:token																								
properties	base xs:token																								
used by	element AcademicStatusType/GraduationDiplomaType																								
facets	<table border="1"> <thead> <tr> <th>Kind</th> <th>Value</th> <th>Annotation</th> </tr> </thead> <tbody> <tr> <td>enumeration</td> <td>04</td> <td></td> </tr> <tr> <td>enumeration</td> <td>05</td> <td></td> </tr> <tr> <td>enumeration</td> <td>06</td> <td></td> </tr> <tr> <td>enumeration</td> <td>07</td> <td></td> </tr> <tr> <td>enumeration</td> <td>13</td> <td></td> </tr> <tr> <td>enumeration</td> <td>15</td> <td></td> </tr> <tr> <td>enumeration</td> <td>17</td> <td></td> </tr> </tbody> </table>	Kind	Value	Annotation	enumeration	04		enumeration	05		enumeration	06		enumeration	07		enumeration	13		enumeration	15		enumeration	17	
Kind	Value	Annotation																							
enumeration	04																								
enumeration	05																								
enumeration	06																								
enumeration	07																								
enumeration	13																								
enumeration	15																								
enumeration	17																								

	enumeration 18 enumeration 19 enumeration 20 enumeration 21 enumeration 22 enumeration 23 enumeration 24 enumeration 25 enumeration 26 enumeration 27 enumeration 28 enumeration 29 enumeration 30 enumeration 31 enumeration 32 enumeration 33 enumeration 34 enumeration 35 enumeration 54 enumeration 55 enumeration 56 enumeration 57
source	<pre> <xs:simpleType name="GraduationDiplomaTypeType"> <xs:restriction base="xs:token"> <xs:enumeration value="04"/> <xs:enumeration value="05"/> <xs:enumeration value="06"/> <xs:enumeration value="07"/> <xs:enumeration value="13"/> <xs:enumeration value="15"/> <xs:enumeration value="17"/> <xs:enumeration value="18"/> <xs:enumeration value="19"/> <xs:enumeration value="20"/> <xs:enumeration value="21"/> <xs:enumeration value="22"/> <xs:enumeration value="23"/> <xs:enumeration value="24"/> <xs:enumeration value="25"/> <xs:enumeration value="26"/> <xs:enumeration value="27"/> <xs:enumeration value="28"/> <xs:enumeration value="29"/> <xs:enumeration value="30"/> <xs:enumeration value="31"/> <xs:enumeration value="32"/> <xs:enumeration value="33"/> <xs:enumeration value="34"/> <xs:enumeration value="35"/> <xs:enumeration value="54"/> </pre>

<pre> <xs:enumeration value="55"/> <xs:enumeration value="56"/> <xs:enumeration value="57"/> <!-- Completion of IEP and full-time employment with sufficient self-help skills to maintain employment without public school services - TAC 89.1070(c)(1), revised August 1, 2002. [26 Tex. Reg. 1837] --> <!-- Completion of IEP and demonstrated mastery of specific employability and self-help skills - TAC 89.1070(c)(2), revised August 1, 2002. [26 Tex. Reg. 1837] --> <!-- Completion of IEP and access to services, employment, or education outside of public education - TAC 89.1070(c)(3), revised August 1, 2002. [26 Tex. Reg. 1837] --> <!-- Completion of IEP and reached age 22 - TAC 89.1070(d), revised August 1, 2002. [26 Tex. Reg. 1837] --> <!-- Minimum High School Program - TAC Chapter 74, revised May, 1998; for all students who entered grade 9 in 1998-99, 1999-00, and 2000-01 (including TAC 89.1070(b)(1) for students receiving special education services, revised August 1, 2002. [26 Tex. Reg. 1837]) --> <!-- Recommended High School Program - TAC Chapter 74, revised May, 1998; for students who entered grade 9 in 1998-99, 1999-00, and 2000-01 (including TAC 89.1070(b)(1) for students receiving special education services, revised August 1, 2002. [26 Tex. Reg. 1837]) --> <!-- Distinguished Achievement Program - TAC Chapter 74, revised May, 1998; for students who entered grade 9 in 1998-99, 1999-00, and 2000-01 (including TAC 89.1070(b)(1) for students receiving special education services, revised August 1, 2002. [26 Tex. Reg. 1837]) --> <!-- Completion of minimum curriculum and credit requirements for graduation applicable to students in general education and participated in the exit-level assessment instrument identified in the IEP - Minimum High School Program - TAC 89.1070(b)(2), revised August 1, 2002. [26 Tex. Reg. 1837] (for students who entered grade 9 in 1998-99 and thereafter) --> <!-- Completion of minimum curriculum and credit requirements for graduation applicable to students in general education and participated in the exit-level assessment instrument identified in the IEP - Recommended High School Program - TAC 89.1070(b)(1), revised August 1, 2002. [26 Tex. Reg. 1837] (for students who entered grade 9 in 1998-99 and thereafter) --> <!-- Completion of minimum curriculum and credit requirements for graduation applicable to students in general education and participated in the exit-level assessment instrument identified in the IEP - Distinguished Achievement Program - TAC 89.1070(b)(1), revised August 1, 2002. [26 Tex. Reg. 1837] (for students who entered grade 9 in 1998-99 and thereafter) --> <!-- Minimum High School Program - TAC Chapter 74, revised June 2000; for students who entered grade 9 in 2001-2002, 2002-2003, and 2003-2004 (including TAC 89.1070(b)(1) for students receiving special education services, revised August 1, 2002. [26 Tex. Reg. 1837]) --> <!-- Recommended High School Program - TAC Chapter 74, revised June 2000; for students who entered grade 9 in 2001-2002, 2002-2003, and 2003-2004 (including TAC 89.1070(b)(1) for students receiving special education services, revised August 1, 2002. [26 Tex. Reg. 1837]) --> <!-- Distinguished Achievement Program - TAC Chapter 74, revised June 2000; for students who entered grade 9 in 2001-2002, 2002-2003, and 2003-2004 (including TAC 89.1070(b)(1) for students receiving special education services, revised August 1, 2002. [26 Tex. Reg. 1837]) --> <!-- Minimum High School Program - TAC Chapter 74, revised November 2003; for students who entered grade 9 in 2004-2005 and thereafter (including TAC </pre>

<p>89.1070(b)(1) for students receiving special education services, revised August 1, 2002.) --></p> <p><!-- Recommended High School Program - TAC Chapter 74, revised November 2003; for students who entered grade 9 in 2004-2005 and thereafter (including TAC 89.1070(b)(1) for students receiving special education services, revised August 1, 2002.) --></p> <p><!-- Distinguished Achievement Program - TAC Chapter 74, revised November 2003; for students who entered grade 9 in 2004-2005 and thereafter (including TAC 89.1070(b)(1) for students receiving special education services, revised August 1, 2002.) --></p> <p><!-- Minimum High School Program - TAC Chapter 74.62, revised September 1, 2005; including TAC 89.1070(b)(2) for students receiving special education services, revised August 1, 2002. (For students who entered grade 9 in 2007-2008, 2008-2009, 2009-2010, 2010-2011, and 2011-2012) --></p> <p><!-- Recommended High School Program - TAC Chapter 74.63, revised September 1, 2005; including TAC 89.1070(b) (1) for students receiving special education services, revised August 1, 2002. (For students who entered grade 9 in 2007-2008, 2008-2009, 2009-2010, 2010-2011, and 2011-2012) --></p> <p><!-- Distinguished Achievement Program - TAC Chapter 74.64, revised September 1, 2005; including TAC 89.1070(b) (1) for students receiving special education services, revised August 1, 2002. (For students who entered grade 9 in 2007-2008, 2008-2009, 2009-2010, 2010-2011, and 2011-2012) --></p> <p><!-- Minimum High School Program - TAC Chapter 74.72, revised May 30, 2012; including TAC 89.1070(b)(2) for students receiving special education services, revised August 1, 2002. (For students who entered grade 9 in 2012-2013 and 2013-2014) --></p> <p><!-- Recommended High School Program - TAC Chapter 74.73, revised May 30, 2012; including TAC 89.1070(b) (1) for students receiving special education services, revised August 1, 2002. (For students who entered grade 9 in 2012-2013 and 2013-2014) --></p> <p><!-- Distinguished Achievement Program - TAC Chapter 74.74, revised May 30, 2012; including TAC 89.1070(b) (1) for students receiving special education services, revised August 1, 2002. (For students who entered grade 9 in 2012-2013 and 2013-2014) --></p> <p><!-- Foundation High School Program (Transitioning Students) - TAC Chapter 74.1022, revised December 16, 2013; including TAC 89.1070(b)(2) for students receiving special education services, revised August 1, 2002. (For students who are completing the fourth/final year of high school during the 2013-2014 school year) --></p> <p><!-- Foundation High School Program - TAC Chapter 74.1021, revised December 16, 2013, TAC 74.12; including TAC 89.1070(b)(1) for students receiving special education services, revised August 1, 2002. (For students who entered grade 9 in 2014-2015 and thereafter or entered grade 9 prior to the 2014-2015 school year and opted to graduate under the Foundation High School Program) --></p> <p><!-- Completion of Minimum Curriculum And Credit Requirements for Graduation Applicable To Students In General Education And Participated In The Exit-Level Assessment Instrument Identified in The IEP-Foundation High School Program (TAC 89.1070(b)(1)) --></p> <p><!-- Completion Of IEP And Full-Time Employment With Sufficient Self-Help Skills To Maintain Employment Without Public School Services (TAC 89.1070(b)(2)(A)) --></p> <p><!-- Completion Of IEP And Demonstrated Mastery Of Specific Employability And Self-Help Skills That Do Not Require Public School Services TAC 89.1070(b)(2)(B) --></p> <p><!-- Completion Of IEP And Access To Services, Employment, Or Education</p>

	<pre> Outside Of Public Education (TAC 89.1070(b)(2)(C)) --> <!-- Completion Of IEP And Reached Age 22 - Foundation (TAC 89.1070(b)(2)(D)) --> </xs:restriction> </xs:simpleType> </pre>
--	---

simpleType **HomelessType**

namespace	urn:us:tx:state:tea:TREx:v1.16																					
type	restriction of xs:token																					
properties	base xs:token																					
used by	element StudentDemographicType/Homeless																					
facets	<table border="1"> <thead> <tr> <th>Kind</th> <th>Value</th> <th>Annotation</th> </tr> </thead> <tbody> <tr> <td>enumeration</td> <td>0</td> <td></td> </tr> <tr> <td>enumeration</td> <td>1</td> <td></td> </tr> <tr> <td>enumeration</td> <td>2</td> <td></td> </tr> <tr> <td>enumeration</td> <td>3</td> <td></td> </tr> <tr> <td>enumeration</td> <td>4</td> <td></td> </tr> <tr> <td>enumeration</td> <td>5</td> <td></td> </tr> </tbody> </table>	Kind	Value	Annotation	enumeration	0		enumeration	1		enumeration	2		enumeration	3		enumeration	4		enumeration	5	
Kind	Value	Annotation																				
enumeration	0																					
enumeration	1																					
enumeration	2																					
enumeration	3																					
enumeration	4																					
enumeration	5																					
source	<pre> <xs:simpleType name="HomelessType"> <xs:restriction base="xs:token"> <xs:enumeration value="0"/> <xs:enumeration value="1"/> <xs:enumeration value="2"/> <xs:enumeration value="3"/> <xs:enumeration value="4"/> <xs:enumeration value="5"/> <!-- Student is not homeless at any time during current school year. --> <!-- Student lives in a shelter, transitional housing, or waiting foster care during current school year. --> <!-- Student lives temporarily doubled-up at any time during current school year. --> <!-- Student is unsheltered at any time during current school year. --> <!-- Student lives in motel or hotel at any time during current school year. --> <!-- Student lives in a shelter or transitional housing at any time during the current school year. --> </xs:restriction> </xs:simpleType> </pre>																					

simpleType **IGCCodeType**

namespace	urn:us:tx:state:tea:TREx:v1.16
type	restriction of xs:token
properties	base xs:token
used by	element AcademicStatusType/IGCGradReview

facets	<table border="1"> <thead> <tr> <th>Kind</th> <th>Value</th> <th>Annotation</th> </tr> </thead> <tbody> <tr> <td>enumeration</td> <td>00</td> <td></td> </tr> <tr> <td>enumeration</td> <td>01</td> <td></td> </tr> </tbody> </table>	Kind	Value	Annotation	enumeration	00		enumeration	01	
Kind	Value	Annotation								
enumeration	00									
enumeration	01									
source	<pre><xs:simpleType name="IGCCodeType"> <xs:restriction base="xs:token"> <xs:enumeration value="00"/> <xs:enumeration value="01"/> <!-- Not Applicable. --> <!-- IGC established, not graduated. --> </xs:restriction> </xs:simpleType></pre>									

simpleType **ImmunizationCodeType**

namespace	urn:us:tx:state:tea:TREx:v1.16									
type	restriction of xs:token									
properties	base xs:token									
used by	element ImmunizationType/ImmunizationCode									
facets	<table border="1"> <thead> <tr> <th>Kind</th> <th>Value</th> <th>Annotation</th> </tr> </thead> <tbody> <tr> <td>minLength</td> <td>1</td> <td></td> </tr> <tr> <td>maxLength</td> <td>35</td> <td></td> </tr> </tbody> </table>	Kind	Value	Annotation	minLength	1		maxLength	35	
Kind	Value	Annotation								
minLength	1									
maxLength	35									
source	<pre><xs:simpleType name="ImmunizationCodeType"> <xs:restriction base="xs:token"> <xs:minLength value="1"/> <xs:maxLength value="35"/> </xs:restriction> </xs:simpleType></pre>									

simpleType **ImmunizationDoseType**

namespace	urn:us:tx:state:tea:TREx:v1.16						
type	restriction of xs:integer						
properties	base xs:integer						
used by	element ImmunizationType/ImmunizationDose						
facets	<table border="1"> <thead> <tr> <th>Kind</th> <th>Value</th> <th>Annotation</th> </tr> </thead> <tbody> <tr> <td>totalDigits</td> <td>2</td> <td></td> </tr> </tbody> </table>	Kind	Value	Annotation	totalDigits	2	
Kind	Value	Annotation					
totalDigits	2						
source	<pre><xs:simpleType name="ImmunizationDoseType"> <xs:restriction base="xs:integer"> <xs:totalDigits value="2"/> </xs:restriction> </xs:simpleType></pre>						

simpleType **LanguageType**

namespace	urn:us:tx:state:tea:TREx:v1.16
-----------	--------------------------------

type	restriction of xs:token		
properties	base xs:token		
used by	element StudentDemographicType/Language		
facets	Kind	Value	Annotation
	enumeration	01	
	enumeration	02	
	enumeration	03	
	enumeration	04	
	enumeration	06	
	enumeration	07	
	enumeration	08	
	enumeration	09	
	enumeration	98	
	enumeration	99	
	enumeration	1A	
	enumeration	1B	
	enumeration	1C	
	enumeration	1D	
	enumeration	1E	
	enumeration	1F	
	enumeration	1G	
	enumeration	1H	
	enumeration	1I	
	enumeration	1J	
	enumeration	1K	
	enumeration	1L	
	enumeration	1M	
	enumeration	1N	
	enumeration	1O	
	enumeration	1P	
	enumeration	1Q	
	enumeration	1R	
	enumeration	1S	
	enumeration	1T	
	enumeration	1U	
	enumeration	1V	
	enumeration	1W	
	enumeration	1X	
	enumeration	1Y	
	enumeration	1Z	
	enumeration	2A	
	enumeration	2B	
	enumeration	2C	
	enumeration	2D	
	enumeration	2E	

enumeration	2F
enumeration	2G
enumeration	2H
enumeration	2I
enumeration	2J
enumeration	2K
enumeration	2L
enumeration	2M
enumeration	2N
enumeration	2O
enumeration	2P
enumeration	2Q
enumeration	2R
enumeration	2S
enumeration	2T
enumeration	2U
enumeration	2V
enumeration	2W
enumeration	2X
enumeration	2Y
enumeration	2Z
enumeration	3A
enumeration	3B
enumeration	3C
enumeration	3D
enumeration	3E
enumeration	3F
enumeration	3G
enumeration	3H
enumeration	3I
enumeration	3J
enumeration	3K
enumeration	3L
enumeration	3M
enumeration	3N
enumeration	3O
enumeration	3P
enumeration	3Q
enumeration	3R
enumeration	3S
enumeration	3T
enumeration	3U
enumeration	3V
enumeration	3W
enumeration	3X

enumeration	3Y
enumeration	3Z
enumeration	4A
enumeration	4B
enumeration	4C
enumeration	4D
enumeration	4E
enumeration	4F
enumeration	4G
enumeration	4H
enumeration	4I
enumeration	4J
enumeration	4K
enumeration	4L
enumeration	4M
enumeration	4N
enumeration	4O
enumeration	4P
enumeration	4Q
enumeration	4R
enumeration	4S
enumeration	4T
enumeration	4U
enumeration	4V
enumeration	4W
enumeration	4X
enumeration	4Y
enumeration	4Z
enumeration	5A
enumeration	5B
enumeration	5C
enumeration	5D
enumeration	5E
enumeration	5F
enumeration	5G
enumeration	5H
enumeration	5I
enumeration	5J
enumeration	5K
enumeration	5L
enumeration	5M
enumeration	5N
enumeration	5O
enumeration	5P
enumeration	5Q

	enumeration 5R enumeration 5S enumeration 5T enumeration 5U enumeration 5V enumeration 5W enumeration 5X enumeration 5Y enumeration 5Z enumeration 6A
source	<pre> <xs:simpleType name="LanguageType"> <xs:restriction base="xs:token"> <xs:enumeration value="01"/> <xs:enumeration value="02"/> <xs:enumeration value="03"/> <xs:enumeration value="04"/> <xs:enumeration value="06"/> <xs:enumeration value="07"/> <xs:enumeration value="08"/> <xs:enumeration value="09"/> <xs:enumeration value="98"/> <xs:enumeration value="99"/> <xs:enumeration value="1A"/> <xs:enumeration value="1B"/> <xs:enumeration value="1C"/> <xs:enumeration value="1D"/> <xs:enumeration value="1E"/> <xs:enumeration value="1F"/> <xs:enumeration value="1G"/> <xs:enumeration value="1H"/> <xs:enumeration value="1I"/> <xs:enumeration value="1J"/> <xs:enumeration value="1K"/> <xs:enumeration value="1L"/> <xs:enumeration value="1M"/> <xs:enumeration value="1N"/> <xs:enumeration value="1O"/> <xs:enumeration value="1P"/> <xs:enumeration value="1Q"/> <xs:enumeration value="1R"/> <xs:enumeration value="1S"/> <xs:enumeration value="1T"/> <xs:enumeration value="1U"/> <xs:enumeration value="1V"/> <xs:enumeration value="1W"/> <xs:enumeration value="1X"/> <xs:enumeration value="1Y"/> <xs:enumeration value="1Z"/> <xs:enumeration value="2A"/> <xs:enumeration value="2B"/> <xs:enumeration value="2C"/> <xs:enumeration value="2D"/> </pre>

```
<xs:enumeration value="2E"/>  
<xs:enumeration value="2F"/>  
<xs:enumeration value="2G"/>  
<xs:enumeration value="2H"/>  
<xs:enumeration value="2I"/>  
<xs:enumeration value="2J"/>  
<xs:enumeration value="2K"/>  
<xs:enumeration value="2L"/>  
<xs:enumeration value="2M"/>  
<xs:enumeration value="2N"/>  
<xs:enumeration value="2O"/>  
<xs:enumeration value="2P"/>  
<xs:enumeration value="2Q"/>  
<xs:enumeration value="2R"/>  
<xs:enumeration value="2S"/>  
<xs:enumeration value="2T"/>  
<xs:enumeration value="2U"/>  
<xs:enumeration value="2V"/>  
<xs:enumeration value="2W"/>  
<xs:enumeration value="2X"/>  
<xs:enumeration value="2Y"/>  
<xs:enumeration value="2Z"/>  
<xs:enumeration value="3A"/>  
<xs:enumeration value="3B"/>  
<xs:enumeration value="3C"/>  
<xs:enumeration value="3D"/>  
<xs:enumeration value="3E"/>  
<xs:enumeration value="3F"/>  
<xs:enumeration value="3G"/>  
<xs:enumeration value="3H"/>  
<xs:enumeration value="3I"/>  
<xs:enumeration value="3J"/>  
<xs:enumeration value="3K"/>  
<xs:enumeration value="3L"/>  
<xs:enumeration value="3M"/>  
<xs:enumeration value="3N"/>  
<xs:enumeration value="3O"/>  
<xs:enumeration value="3P"/>  
<xs:enumeration value="3Q"/>  
<xs:enumeration value="3R"/>  
<xs:enumeration value="3S"/>  
<xs:enumeration value="3T"/>  
<xs:enumeration value="3U"/>  
<xs:enumeration value="3V"/>  
<xs:enumeration value="3W"/>  
<xs:enumeration value="3X"/>  
<xs:enumeration value="3Y"/>  
<xs:enumeration value="3Z"/>  
<xs:enumeration value="4A"/>  
<xs:enumeration value="4B"/>  
<xs:enumeration value="4C"/>  
<xs:enumeration value="4D"/>  
<xs:enumeration value="4E"/>  
<xs:enumeration value="4F"/>  
<xs:enumeration value="4G"/>
```

```
<xs:enumeration value="4H"/>
<xs:enumeration value="4I"/>
<xs:enumeration value="4J"/>
<xs:enumeration value="4K"/>
<xs:enumeration value="4L"/>
<xs:enumeration value="4M"/>
<xs:enumeration value="4N"/>
<xs:enumeration value="4O"/>
<xs:enumeration value="4P"/>
<xs:enumeration value="4Q"/>
<xs:enumeration value="4R"/>
<xs:enumeration value="4S"/>
<xs:enumeration value="4T"/>
<xs:enumeration value="4U"/>
<xs:enumeration value="4V"/>
<xs:enumeration value="4W"/>
<xs:enumeration value="4X"/>
<xs:enumeration value="4Y"/>
<xs:enumeration value="4Z"/>
<xs:enumeration value="5A"/>
<xs:enumeration value="5B"/>
<xs:enumeration value="5C"/>
<xs:enumeration value="5D"/>
<xs:enumeration value="5E"/>
<xs:enumeration value="5F"/>
<xs:enumeration value="5G"/>
<xs:enumeration value="5H"/>
<xs:enumeration value="5I"/>
<xs:enumeration value="5J"/>
<xs:enumeration value="5K"/>
<xs:enumeration value="5L"/>
<xs:enumeration value="5M"/>
<xs:enumeration value="5N"/>
<xs:enumeration value="5O"/>
<xs:enumeration value="5P"/>
<xs:enumeration value="5Q"/>
<xs:enumeration value="5R"/>
<xs:enumeration value="5S"/>
<xs:enumeration value="5T"/>
<xs:enumeration value="5U"/>
<xs:enumeration value="5V"/>
<xs:enumeration value="5W"/>
<xs:enumeration value="5X"/>
<xs:enumeration value="5Y"/>
<xs:enumeration value="5Z"/>
<xs:enumeration value="6A"/>
<!-- Spanish -->
<!-- Vietnamese -->
<!-- Laotian (Lao) -->
<!-- Cambodian (Khmer) -->
<!-- Korean -->
<!-- Japanese -->
<!-- French -->
<!-- German -->
<!-- English -->
```

<pre><!-- Other languages --> <!-- Afrikaans (Taal) --> <!-- Akan (Fante, Asante) --> <!-- Albanian, Gheg (Kosovo/Macedonia) --> <!-- Albanian, Tosk (Albania) --> <!-- Algonquin --> <!-- Amharic --> <!-- Apache --> <!-- Arabic --> <!-- Armenian --> <!-- Assyrian (Syriac, Aramaic) --> <!-- Balinese --> <!-- Bengali --> <!-- Bosnian --> <!-- Bulgarian --> <!-- Burmese --> <!-- Cantonese (Chinese) --> <!-- Cebuano (Visayan) --> <!-- Chamorro --> <!-- Chaochow/Teochiu (Chinese) --> <!-- Cherokee --> <!-- Chippewa/Ojibawa/Ottawa --> <!-- Choctaw --> <!-- Comanche --> <!-- Coushatta --> <!-- Creek --> <!-- Croatian --> <!-- Crow --> <!-- Czech --> <!-- Danish --> <!-- Dard --> <!-- Dutch/Flemish --> <!-- Efik --> <!-- Eskimo --> <!-- Estonian --> <!-- Ethiopic --> <!-- Ewe --> <!-- Farsi (Persian) --> <!-- Finnish --> <!-- Fukien/Hokkien (Chinese) --> <!-- Gaelic (Irish) --> <!-- Gaelic (Scottish) --> <!-- Greek --> <!-- Gujarati --> <!-- Guyanese --> <!-- Hainanese (Chinese) --> <!-- Haitian-Creole --> <!-- Hakka (Chinese) --> <!-- Hausa --> <!-- Hebrew --> <!-- Hindi --> <!-- Hmong --> <!-- Hopi --> <!-- Hungarian --> <!-- Ibo/Igbo --></pre>

	<pre><!-- Icelandic --> <!-- Ilonggo (Hiligaynon) --> <!-- Indonesian --> <!-- Italian --> <!-- Kache (Kaje, Jju) --> <!-- Kannada (Kanarese) --> <!-- Kanuri --> <!-- Kashmiri --> <!-- Kickapoo --> <!-- Konkani --> <!-- Kpelle --> <!-- Krio --> <!-- Kurdish --> <!-- Kwa --> <!-- Latvian --> <!-- Lingala --> <!-- Lithuanian --> <!-- Luganda --> <!-- Lunda --> <!-- Luyia (Luhya) --> <!-- Macedonian --> <!-- Malay --> <!-- Malayalam --> <!-- Maltese --> <!-- Mandarin (Chinese) --> <!-- Mande --> <!-- Marathi --> <!-- Menominee --> <!-- Mien (Yao) --> <!-- Navajo --> <!-- Nepali --> <!-- Norwegian --> <!-- Okinawan --> <!-- Oneida --> <!-- Oriya --> <!-- Orri (Oring) --> <!-- Pampangan --> <!-- Panjabi (Punjabi) --> <!-- Pashto (Pushto) --> <!-- Pilipino (Tagalog) --> <!-- Pima --> <!-- Polish --> <!-- Portuguese --> <!-- Pueblo --> <!-- Romanian --> <!-- Romany (Gypsy) --> <!-- Russian --> <!-- Samoan --> <!-- Serbian --> <!-- Shanghai (Chinese) --> <!-- Shona --> <!-- Sikkimese --> <!-- Sindhi --> <!-- Sinhalese (Sri Lanka) --> <!-- Sioux (Dakota) --></pre>
--	---

	<pre> <!-- Slavic --> <!-- Slovenian (Slovene) --> <!-- Somali --> <!-- Sotho --> <!-- Swahili --> <!-- Swedish --> <!-- Taiwanese/Formosan/Min Nan (Chinese) --> <!-- Tamil --> <!-- Telugu (Telegu) --> <!-- Thai --> <!-- Tibetan --> <!-- Tigrinya --> <!-- Tiwa --> <!-- Tuluau --> <!-- Turkish --> <!-- Ukrainian --> <!-- Urdu --> <!-- Welsh --> <!-- Winnebago --> <!-- Yiddish --> <!-- Yombe --> <!-- Yoruba --> </xs:restriction> </xs:simpleType> </pre>
--	--

simpleType LastNameType

namespace	urn:us:tx:state:tea:TREx:v1.16									
type	restriction of xs:token									
properties	base xs:token									
used by	element PersonNameType/LastName									
facets	<table border="1"> <thead> <tr> <th>Kind</th> <th>Value</th> <th>Annotation</th> </tr> </thead> <tbody> <tr> <td>minLength</td> <td>1</td> <td></td> </tr> <tr> <td>maxLength</td> <td>40</td> <td></td> </tr> </tbody> </table>	Kind	Value	Annotation	minLength	1		maxLength	40	
Kind	Value	Annotation								
minLength	1									
maxLength	40									
source	<pre> <xs:simpleType name="LastNameType"> <xs:restriction base="xs:token"> <xs:minLength value="1"/> <xs:maxLength value="40"/> </xs:restriction> </xs:simpleType> </pre>									

simpleType LEPType

namespace	urn:us:tx:state:tea:TREx:v1.16
type	restriction of xs:token
properties	base xs:token
used by	element SpecialProgramsType/LEP

facets	<table border="1"> <thead> <tr> <th>Kind</th> <th>Value</th> <th>Annotation</th> </tr> </thead> <tbody> <tr> <td>enumeration</td> <td>0</td> <td></td> </tr> <tr> <td>enumeration</td> <td>1</td> <td></td> </tr> <tr> <td>enumeration</td> <td>F</td> <td></td> </tr> <tr> <td>enumeration</td> <td>S</td> <td></td> </tr> </tbody> </table>	Kind	Value	Annotation	enumeration	0		enumeration	1		enumeration	F		enumeration	S	
Kind	Value	Annotation														
enumeration	0															
enumeration	1															
enumeration	F															
enumeration	S															
source	<pre><xs:simpleType name="LEPType"> <xs:restriction base="xs:token"> <xs:enumeration value="0"/> <xs:enumeration value="1"/> <xs:enumeration value="F"/> <xs:enumeration value="S"/> <!-- Not LEP --> <!-- Identified as limited English proficient (LEP) --> <!-- Student exited from LEP status - Monitored 1st year --> <!-- Student exited from LEP status - Monitored 2nd year --> </xs:restriction> </xs:simpleType></pre>															

simpleType **LocalIDType**

namespace	urn:us:tx:state:tea:TREx:v1.16									
type	restriction of xs:token									
properties	base xs:token									
used by	element StudentIdentificationType/LocalID									
facets	<table border="1"> <thead> <tr> <th>Kind</th> <th>Value</th> <th>Annotation</th> </tr> </thead> <tbody> <tr> <td>minLength</td> <td>1</td> <td></td> </tr> <tr> <td>maxLength</td> <td>9</td> <td></td> </tr> </tbody> </table>	Kind	Value	Annotation	minLength	1		maxLength	9	
Kind	Value	Annotation								
minLength	1									
maxLength	9									
source	<pre><xs:simpleType name="LocalIDType"> <xs:restriction base="xs:token"> <xs:minLength value="1"/> <xs:maxLength value="9"/> </xs:restriction> </xs:simpleType></pre>									

simpleType **MiddleNameType**

namespace	urn:us:tx:state:tea:TREx:v1.16									
type	restriction of xs:token									
properties	base xs:token									
used by	element PersonNameType/MiddleName									
facets	<table border="1"> <thead> <tr> <th>Kind</th> <th>Value</th> <th>Annotation</th> </tr> </thead> <tbody> <tr> <td>minLength</td> <td>1</td> <td></td> </tr> <tr> <td>maxLength</td> <td>30</td> <td></td> </tr> </tbody> </table>	Kind	Value	Annotation	minLength	1		maxLength	30	
Kind	Value	Annotation								
minLength	1									
maxLength	30									
source	<pre><xs:simpleType name="MiddleNameType"> <xs:restriction base="xs:token"> <xs:minLength value="1"/> </xs:restriction> </xs:simpleType></pre>									

	<pre> <xs:maxLength value="30"/> </xs:restriction> </xs:simpleType> </pre>
--	--

simpleType **MilitaryConnectedType**

namespace	urn:us:tx:state:tea:TREx:v1.16																		
type	restriction of xs:token																		
properties	base xs:token																		
used by	element StudentDemographicType/MilitaryConnected																		
facets	<table border="1"> <thead> <tr> <th>Kind</th> <th>Value</th> <th>Annotation</th> </tr> </thead> <tbody> <tr> <td>enumeration</td> <td>0</td> <td></td> </tr> <tr> <td>enumeration</td> <td>1</td> <td></td> </tr> <tr> <td>enumeration</td> <td>2</td> <td></td> </tr> <tr> <td>enumeration</td> <td>3</td> <td></td> </tr> <tr> <td>enumeration</td> <td>4</td> <td></td> </tr> </tbody> </table>	Kind	Value	Annotation	enumeration	0		enumeration	1		enumeration	2		enumeration	3		enumeration	4	
Kind	Value	Annotation																	
enumeration	0																		
enumeration	1																		
enumeration	2																		
enumeration	3																		
enumeration	4																		
source	<pre> <xs:simpleType name="MilitaryConnectedType"> <xs:restriction base="xs:token"> <xs:enumeration value="0"/> <xs:enumeration value="1"/> <xs:enumeration value="2"/> <xs:enumeration value="3"/> <xs:enumeration value="4"/> <!-- Not a military-connected student. --> <!-- Dependent of a Active Duty member of the U.S. Military. --> <!-- Dependent of a member of the Texas National Guard. --> <!-- Dependent of a member of a Reserve force in the U.S. Military. --> <!-- Pre-K dependent of active duty service member, Texas guard, or Reserve injured or killed on active duty. --> </xs:restriction> </xs:simpleType> </pre>																		

simpleType **ParticipationType**

namespace	urn:us:tx:state:tea:TREx:v1.16									
type	restriction of xs:token									
properties	base xs:token									
used by	elements AcademicStatusType/AssociateDegree SpecialProgramsType/AtRisk StudentDemographicType/Dyslexia AcademicStatusType/FHSPCollegeCareerInstructionIndicator SpecialProgramsType/IEP StudentDemographicType/Migrant AcademicStatusType/OnRamps SpecialProgramsType/PersonalGradPlan SpecialProgramsType/SpecialEd									
facets	<table border="1"> <thead> <tr> <th>Kind</th> <th>Value</th> <th>Annotation</th> </tr> </thead> <tbody> <tr> <td>enumeration</td> <td>0</td> <td></td> </tr> <tr> <td>enumeration</td> <td>1</td> <td></td> </tr> </tbody> </table>	Kind	Value	Annotation	enumeration	0		enumeration	1	
Kind	Value	Annotation								
enumeration	0									
enumeration	1									
source	<pre> <xs:simpleType name="ParticipationType"> <xs:restriction base="xs:token"> <xs:enumeration value="0"/> </pre>									

	<pre> <xs:enumeration value="1"/> <!-- Not receiving services, or condition or situation not applicable to this person or campus. --> <!-- Participant in program or service, or condition or situation applicable to this person or campus. --> </xs:restriction> </xs:simpleType> </pre>
--	--

simpleType **PassFailCreditType**

namespace	urn:us:tx:state:tea:TREx:v1.16																																																
type	restriction of xs:token																																																
properties	base xs:token																																																
used by	element CourseType/PassFailCredit																																																
facets	<table border="1"> <thead> <tr> <th>Kind</th> <th>Value</th> <th>Annotation</th> </tr> </thead> <tbody> <tr><td>enumeration</td><td>00</td><td></td></tr> <tr><td>enumeration</td><td>01</td><td></td></tr> <tr><td>enumeration</td><td>02</td><td></td></tr> <tr><td>enumeration</td><td>03</td><td></td></tr> <tr><td>enumeration</td><td>04</td><td></td></tr> <tr><td>enumeration</td><td>05</td><td></td></tr> <tr><td>enumeration</td><td>06</td><td></td></tr> <tr><td>enumeration</td><td>07</td><td></td></tr> <tr><td>enumeration</td><td>08</td><td></td></tr> <tr><td>enumeration</td><td>09</td><td></td></tr> <tr><td>enumeration</td><td>10</td><td></td></tr> <tr><td>enumeration</td><td>11</td><td></td></tr> <tr><td>enumeration</td><td>12</td><td></td></tr> <tr><td>enumeration</td><td>13</td><td></td></tr> <tr><td>enumeration</td><td>14</td><td></td></tr> </tbody> </table>	Kind	Value	Annotation	enumeration	00		enumeration	01		enumeration	02		enumeration	03		enumeration	04		enumeration	05		enumeration	06		enumeration	07		enumeration	08		enumeration	09		enumeration	10		enumeration	11		enumeration	12		enumeration	13		enumeration	14	
Kind	Value	Annotation																																															
enumeration	00																																																
enumeration	01																																																
enumeration	02																																																
enumeration	03																																																
enumeration	04																																																
enumeration	05																																																
enumeration	06																																																
enumeration	07																																																
enumeration	08																																																
enumeration	09																																																
enumeration	10																																																
enumeration	11																																																
enumeration	12																																																
enumeration	13																																																
enumeration	14																																																
source	<pre> <xs:simpleType name="PassFailCreditType"> <xs:restriction base="xs:token"> <xs:enumeration value="00"/> <xs:enumeration value="01"/> <xs:enumeration value="02"/> <xs:enumeration value="03"/> <xs:enumeration value="04"/> <xs:enumeration value="05"/> <xs:enumeration value="06"/> <xs:enumeration value="07"/> <xs:enumeration value="08"/> <xs:enumeration value="09"/> <xs:enumeration value="10"/> <xs:enumeration value="11"/> <xs:enumeration value="12"/> <xs:enumeration value="13"/> <xs:enumeration value="14"/> <!-- Course was passed and credit was received --> </xs:restriction> </xs:simpleType> </pre>																																																

```

<!-- Not Applicable -->
<!-- Course was failed and no credit was received - first occurrence this
school year -->
<!-- Course was failed and no credit was received - second occurrence this
school year -->
<!-- Course was passed, but credit was not received due to excessive
absences - first occurrence this school year -->
<!-- Course was passed, but credit was not received due to excessive
absences - second occurrence this school year -->
<!-- Course was passed, but credit was not received (other parts of the
course have not been taken) -->
<!-- Course was passed, but credit was not received (other parts of the
course have been taken but not passed) -->
<!-- Course was failed, but credit was received (other parts of the course
have been passed and credit was awarded based on the grades in those parts) -->
<!-- Course work is incomplete and no credit has been awarded -->
<!-- Course was passed, but credit was not received (course had previously
been passed, and was repeated for better mastery) -->
<!-- Course was failed and no credit was received - third occurrence this
school year -->
<!-- Course was passed, but credit was not received due to excessive
absences - third occurrence this school year -->
<!-- Non-High School Course Passed -->
<!-- Non-High School Course Failed -->
</xs:restriction>
</xs:simpleType>

```

simpleType **PerfAckAplbCode**

namespace	urn:us:tx:state:tea:TREx:v1.16																																													
type	restriction of xs:token																																													
properties	base xs:token																																													
used by	element PerfAckAplbType/AplbCode																																													
facets	<table border="1"> <thead> <tr> <th>Kind</th> <th>Value</th> <th>Annotation</th> </tr> </thead> <tbody> <tr><td>enumeration</td><td>0</td><td></td></tr> <tr><td>enumeration</td><td>1</td><td></td></tr> <tr><td>enumeration</td><td>2</td><td></td></tr> <tr><td>enumeration</td><td>3</td><td></td></tr> <tr><td>enumeration</td><td>4</td><td></td></tr> <tr><td>enumeration</td><td>5</td><td></td></tr> <tr><td>enumeration</td><td>6</td><td></td></tr> <tr><td>enumeration</td><td>7</td><td></td></tr> <tr><td>enumeration</td><td>8</td><td></td></tr> <tr><td>enumeration</td><td>9</td><td></td></tr> <tr><td>enumeration</td><td>10</td><td></td></tr> <tr><td>enumeration</td><td>11</td><td></td></tr> <tr><td>enumeration</td><td>12</td><td></td></tr> <tr><td>enumeration</td><td>13</td><td></td></tr> </tbody> </table>	Kind	Value	Annotation	enumeration	0		enumeration	1		enumeration	2		enumeration	3		enumeration	4		enumeration	5		enumeration	6		enumeration	7		enumeration	8		enumeration	9		enumeration	10		enumeration	11		enumeration	12		enumeration	13	
Kind	Value	Annotation																																												
enumeration	0																																													
enumeration	1																																													
enumeration	2																																													
enumeration	3																																													
enumeration	4																																													
enumeration	5																																													
enumeration	6																																													
enumeration	7																																													
enumeration	8																																													
enumeration	9																																													
enumeration	10																																													
enumeration	11																																													
enumeration	12																																													
enumeration	13																																													

enumeration	14
enumeration	15
enumeration	16
enumeration	17
enumeration	18
enumeration	19
enumeration	20
enumeration	21
enumeration	22
enumeration	23
enumeration	24
enumeration	25
enumeration	26
enumeration	27
enumeration	28
enumeration	29
enumeration	30
enumeration	31
enumeration	32
enumeration	33
enumeration	34
enumeration	35
enumeration	36
enumeration	37
enumeration	38
enumeration	39
enumeration	40
enumeration	41
enumeration	42
enumeration	43
enumeration	44
enumeration	45
enumeration	46
enumeration	47
enumeration	48
enumeration	49
enumeration	50
enumeration	51
enumeration	52
enumeration	53
enumeration	54
enumeration	55
enumeration	56
enumeration	57
enumeration	58

enumeration	59
enumeration	60
enumeration	61
enumeration	62
enumeration	63
enumeration	64
enumeration	65
enumeration	66
enumeration	67
enumeration	68
enumeration	69
enumeration	70
enumeration	71
enumeration	72
enumeration	73
enumeration	74
enumeration	75
enumeration	76
enumeration	77
enumeration	78
enumeration	79
enumeration	80
enumeration	81
enumeration	82
enumeration	83
enumeration	84
enumeration	85
enumeration	86
enumeration	87
enumeration	88
enumeration	89
enumeration	90
enumeration	91
enumeration	92
enumeration	93
enumeration	94
enumeration	95
enumeration	96
enumeration	97
enumeration	98
enumeration	99
enumeration	100
enumeration	101
enumeration	102
enumeration	103

	enumeration 104 enumeration 105 enumeration 106 enumeration 107 enumeration 108 enumeration 109 enumeration 110 enumeration 111 enumeration 112 enumeration 113 enumeration 114 enumeration 115 enumeration 116 enumeration 117 enumeration 118 enumeration 119 enumeration 120 enumeration 121 enumeration 122 enumeration 123 enumeration 124 enumeration 125 enumeration 126 enumeration 127 enumeration 128 enumeration 129 enumeration 150
source	<pre> <xs:simpleType name="PerfAckApIbCode"> <xs:restriction base="xs:token"> <xs:enumeration value="0"/> <xs:enumeration value="1"/> <xs:enumeration value="2"/> <xs:enumeration value="3"/> <xs:enumeration value="4"/> <xs:enumeration value="5"/> <xs:enumeration value="6"/> <xs:enumeration value="7"/> <xs:enumeration value="8"/> <xs:enumeration value="9"/> <xs:enumeration value="10"/> <xs:enumeration value="11"/> <xs:enumeration value="12"/> <xs:enumeration value="13"/> <xs:enumeration value="14"/> <xs:enumeration value="15"/> <xs:enumeration value="16"/> <xs:enumeration value="17"/> <xs:enumeration value="18"/> <xs:enumeration value="19"/> </pre>

```
<xs:enumeration value="20"/>  
<xs:enumeration value="21"/>  
<xs:enumeration value="22"/>  
<xs:enumeration value="23"/>  
<xs:enumeration value="24"/>  
<xs:enumeration value="25"/>  
<xs:enumeration value="26"/>  
<xs:enumeration value="27"/>  
<xs:enumeration value="28"/>  
<xs:enumeration value="29"/>  
<xs:enumeration value="30"/>  
<xs:enumeration value="31"/>  
<xs:enumeration value="32"/>  
<xs:enumeration value="33"/>  
<xs:enumeration value="34"/>  
<xs:enumeration value="35"/>  
<xs:enumeration value="36"/>  
<xs:enumeration value="37"/>  
<xs:enumeration value="38"/>  
<xs:enumeration value="39"/>  
<xs:enumeration value="40"/>  
<xs:enumeration value="41"/>  
<xs:enumeration value="42"/>  
<xs:enumeration value="43"/>  
<xs:enumeration value="44"/>  
<xs:enumeration value="45"/>  
<xs:enumeration value="46"/>  
<xs:enumeration value="47"/>  
<xs:enumeration value="48"/>  
<xs:enumeration value="49"/>  
<xs:enumeration value="50"/>  
<xs:enumeration value="51"/>  
<xs:enumeration value="52"/>  
<xs:enumeration value="53"/>  
<xs:enumeration value="54"/>  
<xs:enumeration value="55"/>  
<xs:enumeration value="56"/>  
<xs:enumeration value="57"/>  
<xs:enumeration value="58"/>  
<xs:enumeration value="59"/>  
<xs:enumeration value="60"/>  
<xs:enumeration value="61"/>  
<xs:enumeration value="62"/>  
<xs:enumeration value="63"/>  
<xs:enumeration value="64"/>  
<xs:enumeration value="65"/>  
<xs:enumeration value="66"/>  
<xs:enumeration value="67"/>  
<xs:enumeration value="68"/>  
<xs:enumeration value="69"/>  
<xs:enumeration value="70"/>  
<xs:enumeration value="71"/>  
<xs:enumeration value="72"/>  
<xs:enumeration value="73"/>  
<xs:enumeration value="74"/>
```

```
<xs:enumeration value="75"/>  
<xs:enumeration value="76"/>  
<xs:enumeration value="77"/>  
<xs:enumeration value="78"/>  
<xs:enumeration value="79"/>  
<xs:enumeration value="80"/>  
<xs:enumeration value="81"/>  
<xs:enumeration value="82"/>  
<xs:enumeration value="83"/>  
<xs:enumeration value="84"/>  
<xs:enumeration value="85"/>  
<xs:enumeration value="86"/>  
<xs:enumeration value="87"/>  
<xs:enumeration value="88"/>  
<xs:enumeration value="89"/>  
<xs:enumeration value="90"/>  
<xs:enumeration value="91"/>  
<xs:enumeration value="92"/>  
<xs:enumeration value="93"/>  
<xs:enumeration value="94"/>  
<xs:enumeration value="95"/>  
<xs:enumeration value="96"/>  
<xs:enumeration value="97"/>  
<xs:enumeration value="98"/>  
<xs:enumeration value="99"/>  
<xs:enumeration value="100"/>  
<xs:enumeration value="101"/>  
<xs:enumeration value="102"/>  
<xs:enumeration value="103"/>  
<xs:enumeration value="104"/>  
<xs:enumeration value="105"/>  
<xs:enumeration value="106"/>  
<xs:enumeration value="107"/>  
<xs:enumeration value="108"/>  
<xs:enumeration value="109"/>  
<xs:enumeration value="110"/>  
<xs:enumeration value="111"/>  
<xs:enumeration value="112"/>  
<xs:enumeration value="113"/>  
<xs:enumeration value="114"/>  
<xs:enumeration value="115"/>  
<xs:enumeration value="116"/>  
<xs:enumeration value="117"/>  
<xs:enumeration value="118"/>  
<xs:enumeration value="119"/>  
<xs:enumeration value="120"/>  
<xs:enumeration value="121"/>  
<xs:enumeration value="122"/>  
<xs:enumeration value="123"/>  
<xs:enumeration value="124"/>  
<xs:enumeration value="125"/>  
<xs:enumeration value="126"/>  
<xs:enumeration value="127"/>  
<xs:enumeration value="128"/>  
<xs:enumeration value="129"/>
```

	<pre> <x:enumeration value="150"/> <!-- Student not acknowledged for AP or IB Exam --> <!-- Acknowledgment for AP: Art History --> <!-- Acknowledgment for AP: Biology --> <!-- Acknowledgment for AP: Calculus AB --> <!-- Acknowledgment for AP: Calculus BC --> <!-- Acknowledgment for AP: Chemistry --> <!-- Acknowledgment for AP: Chinese Language and Culture --> <!-- Acknowledgment for AP: Comparative Government & Politics --> <!-- Acknowledgment for AP: Computer Science A --> <!-- Acknowledgment for AP: English Language & Composition --> <!-- Acknowledgment for AP: English Literature & Composition --> <!-- Acknowledgment for AP: Environmental Science --> <!-- Acknowledgment for AP: European History --> <!-- Acknowledgment for AP: French Language and Culture --> <!-- Acknowledgment for AP: German Language and Culture --> <!-- Acknowledgment for AP: Human Geography --> <!-- Acknowledgment for AP: Italian Language and Culture --> <!-- Acknowledgment for AP: Japanese Language and Culture --> <!-- Acknowledgment for AP: Latin --> <!-- Acknowledgment for AP: Macroeconomics --> <!-- Acknowledgment for AP: Microeconomics --> <!-- Acknowledgment for AP: Music Theory --> <!-- Acknowledgment for AP: Physics 1: Algebra-Based --> <!-- Acknowledgment for AP: Physics 2: Algebra-Based --> <!-- Acknowledgment for AP: Physics B --> <!-- Acknowledgment for AP: Physics C: Electricity and Magnetism --> <!-- Acknowledgment for AP: Physics C: Mechanics --> <!-- Acknowledgment for AP: Psychology --> <!-- Acknowledgment for AP: Spanish Language and Culture --> <!-- Acknowledgment for AP: Spanish Literature and Culture --> <!-- Acknowledgment for AP: Statistics --> <!-- Acknowledgment for AP: Studio Art 2-D Design --> <!-- Acknowledgment for AP: Studio Art 3-D Design --> <!-- Acknowledgment for AP: Studio Art Drawing --> <!-- Acknowledgment for AP: United States Government & Politics --> <!-- Acknowledgment for AP: United States History --> <!-- Acknowledgment for AP: World History --> <!-- Acknowledgment for IB: Biology HL --> <!-- Acknowledgment for IB: Biology SL --> <!-- Acknowledgment for IB: Business & management HL --> <!-- Acknowledgment for IB: Business & management SL --> <!-- Acknowledgment for IB: Chemistry HL --> <!-- Acknowledgment for IB: Chemistry SL --> <!-- Acknowledgment for IB: Chinese A Language & Literature HL --> <!-- Acknowledgment for IB: Chinese A Language & Literature SL --> <!-- Acknowledgment for IB: Chinese A Literature HL --> <!-- Acknowledgment for IB: Chinese A Literature SL --> <!-- Acknowledgment for IB: Chinese ab initio SL --> <!-- Acknowledgment for IB: Chinese B HL --> <!-- Acknowledgment for IB: Chinese B SL --> <!-- Acknowledgment for IB: Classical Greek HL --> <!-- Acknowledgment for IB: Classical Greek SL --> <!-- Acknowledgment for IB: Computer science HL --> <!-- Acknowledgment for IB: Computer science SL --> </pre>
--	--

<pre> <!-- Acknowledgment for IB: Design technology HL --> <!-- Acknowledgment for IB: Design technology SL --> <!-- Acknowledgment for IB: Economics HL --> <!-- Acknowledgment for IB: Economics SL --> <!-- Acknowledgment for IB: English A Language & Literature HL --> <!-- Acknowledgment for IB: English A Language & Literature SL --> <!-- Acknowledgment for IB: English A Literature HL --> <!-- Acknowledgment for IB: English A Literature SL --> <!-- Acknowledgment for IB: English ab initio SL --> <!-- Acknowledgment for IB: English B HL --> <!-- Acknowledgment for IB: English B SL --> <!-- Acknowledgment for IB: Environmental systems & societies SL --> <!-- Acknowledgment for IB: French A Language & Literature HL --> <!-- Acknowledgment for IB: French A Language & Literature SL --> <!-- Acknowledgment for IB: French A Literature HL --> <!-- Acknowledgment for IB: French A Literature SL --> <!-- Acknowledgment for IB: French ab initio SL --> <!-- Acknowledgment for IB: French B HL --> <!-- Acknowledgment for IB: French B SL --> <!-- Acknowledgment for IB: Further mathematics HL --> <!-- Acknowledgment for IB: Geography HL --> <!-- Acknowledgment for IB: Geography HL/SL --> <!-- Acknowledgment for IB: Geography SL --> <!-- Acknowledgment for IB: German A Language & Literature HL --> <!-- Acknowledgment for IB: German A Language & Literature SL --> <!-- Acknowledgment for IB: German A Literature HL --> <!-- Acknowledgment for IB: German A Literature SL --> <!-- Acknowledgment for IB: German ab initio --> <!-- Acknowledgment for IB: German ab initio SL --> <!-- Acknowledgment for IB: German B HL --> <!-- Acknowledgment for IB: German B SL --> <!-- Acknowledgment for IB: Global politics HL --> <!-- Acknowledgment for IB: Global politics HL/SL --> <!-- Acknowledgment for IB: Global politics SL --> <!-- Acknowledgment for IB: History HL --> <!-- Acknowledgment for IB: History HL/SL --> <!-- Acknowledgment for IB: Information Technology in a Global Society (ITGS) HL --> <!-- Acknowledgment for IB: Information Technology in a Global Society (ITGS) HL/SL --> <!-- Acknowledgment for IB: Information Technology in a Global Society (ITGS) SL --> <!-- Acknowledgment for IB: Language A Language & Literature HL --> <!-- Acknowledgment for IB: Language A Language & Literature SL --> <!-- Acknowledgment for IB: Language A Literature HL --> <!-- Acknowledgment for IB: Language A Literature SL --> <!-- Acknowledgment for IB: Language ab initio SL --> <!-- Acknowledgment for IB: Language B HL --> <!-- Acknowledgment for IB: Language B SL --> <!-- Acknowledgment for IB: Latin HL --> <!-- Acknowledgment for IB: Latin SL --> <!-- Acknowledgment for IB: Literature & performance SL --> <!-- Acknowledgment for IB: Mathematical studies SL --> <!-- Acknowledgment for IB: Mathematics HL --> <!-- Acknowledgment for IB: Mathematics SL --> </pre>

	<pre> <!-- Acknowledgment for IB: Music HL --> <!-- Acknowledgment for IB: Music SL --> <!-- Acknowledgment for IB: Philosophy HL --> <!-- Acknowledgment for IB: Philosophy HL/SL --> <!-- Acknowledgment for IB: Philosophy SL --> <!-- Acknowledgment for IB: Physics HL --> <!-- Acknowledgment for IB: Physics SL --> <!-- Acknowledgment for IB: Psychology HL --> <!-- Acknowledgment for IB: Psychology HL/SL --> <!-- Acknowledgment for IB: Psychology SL --> <!-- Acknowledgment for IB: School-based syllabus SL --> <!-- Acknowledgment for IB: Social & cultural anthropology HL --> <!-- Acknowledgment for IB: Social & cultural anthropology SL --> <!-- Acknowledgment for IB: Spanish A Language & Literature HL --> <!-- Acknowledgment for IB: Spanish A Language & Literature SL --> <!-- Acknowledgment for IB: Spanish A Literature HL --> <!-- Acknowledgment for IB: Spanish A Literature SL --> <!-- Acknowledgment for IB: Spanish ab initio SL --> <!-- Acknowledgment for IB: Spanish B HL --> <!-- Acknowledgment for IB: Spanish B SL --> <!-- Acknowledgment for IB: Sports, exercise & health science SL --> <!-- Acknowledgment for IB: World religions SL --> <!-- Acknowledgment for AP: Computer Science Principles --> <!-- Acknowledgment for AP: Capstone Seminar --> <!-- Acknowledgment for IB: Nature of Science SL --> </xs:restriction> </xs:simpleType> </pre>
--	---

simpleType **PerfAckBilingBilitCode**

namespace	urn:us:tx:state:tea:TReX:v1.16									
type	restriction of xs:token									
properties	base xs:token									
used by	element PerfAckBilingBilitType/BilingBilitCode									
facets	<table border="1"> <thead> <tr> <th>Kind</th> <th>Value</th> <th>Annotation</th> </tr> </thead> <tbody> <tr> <td>enumeration</td> <td>0</td> <td></td> </tr> <tr> <td>enumeration</td> <td>1</td> <td></td> </tr> </tbody> </table>	Kind	Value	Annotation	enumeration	0		enumeration	1	
Kind	Value	Annotation								
enumeration	0									
enumeration	1									
source	<pre> <xs:simpleType name="PerfAckBilingBilitCode"> <xs:restriction base="xs:token"> <xs:enumeration value="0"/> <xs:enumeration value="1"/> <!-- Not Acknowledged for Bilingualism and biliteracy --> <!-- Acknowledgment for Bilingualism and biliteracy --> </xs:restriction> </xs:simpleType> </pre>									

simpleType **PerfAckCertLicCode**

namespace	urn:us:tx:state:tea:TReX:v1.16
-----------	--------------------------------

type	restriction of xs:token									
properties	base xs:token									
used by	element PerfAckCertLicType/CertLicCode									
facets	<table border="1"> <thead> <tr> <th>Kind</th> <th>Value</th> <th>Annotation</th> </tr> </thead> <tbody> <tr> <td>minLength</td> <td>1</td> <td></td> </tr> <tr> <td>maxLength</td> <td>61</td> <td></td> </tr> </tbody> </table>	Kind	Value	Annotation	minLength	1		maxLength	61	
Kind	Value	Annotation								
minLength	1									
maxLength	61									
source	<pre><xs:simpleType name="PerfAckCertLicCode"> <xs:restriction base="xs:token"> <xs:minLength value="1"/> <xs:maxLength value="61"/> </xs:restriction> </xs:simpleType></pre>									

simpleType **PerfAckCollegeAssessCode**

namespace	urn:us:tx:state:tea:TREx:v1.16																					
type	restriction of xs:token																					
properties	base xs:token																					
used by	element PerfAckCollegeAssessType/CollegeAssessCode																					
facets	<table border="1"> <thead> <tr> <th>Kind</th> <th>Value</th> <th>Annotation</th> </tr> </thead> <tbody> <tr> <td>enumeration</td> <td>0</td> <td></td> </tr> <tr> <td>enumeration</td> <td>1</td> <td></td> </tr> <tr> <td>enumeration</td> <td>2</td> <td></td> </tr> <tr> <td>enumeration</td> <td>3</td> <td></td> </tr> <tr> <td>enumeration</td> <td>4</td> <td></td> </tr> <tr> <td>enumeration</td> <td>5</td> <td></td> </tr> </tbody> </table>	Kind	Value	Annotation	enumeration	0		enumeration	1		enumeration	2		enumeration	3		enumeration	4		enumeration	5	
Kind	Value	Annotation																				
enumeration	0																					
enumeration	1																					
enumeration	2																					
enumeration	3																					
enumeration	4																					
enumeration	5																					
source	<pre><xs:simpleType name="PerfAckCollegeAssessCode"> <xs:restriction base="xs:token"> <xs:enumeration value="0"/> <xs:enumeration value="1"/> <xs:enumeration value="2"/> <xs:enumeration value="3"/> <xs:enumeration value="4"/> <xs:enumeration value="5"/> <!-- Student not acknowledged for Assessment --> <!-- Acknowledgment for PLAN or ASPIRE: College readiness benchmark met on 2 or more of the 4 subject tests --> <!-- Acknowledgment for PSAT: Commended scholar or higher --> <!-- Acknowledgment for ACT: Composite score 28 or higher --> <!-- Acknowledgment for SAT: Prior to March 2016, combined reading and math score 1250 or higher --> <!-- Acknowledgment for SAT: As of March 2016, scores of at least 410 on reading and 520 on math --> </xs:restriction> </xs:simpleType></pre>																					

simpleType **PerfAckDualCreditCode**

namespace	urn:us:tx:state:tea:TREx:v1.16												
type	restriction of xs:token												
properties	base xs:token												
used by	element PerfAckDualCreditType/DualCreditCode												
facets	<table border="1"> <thead> <tr> <th>Kind</th> <th>Value</th> <th>Annotation</th> </tr> </thead> <tbody> <tr> <td>enumeration</td> <td>0</td> <td></td> </tr> <tr> <td>enumeration</td> <td>1</td> <td></td> </tr> <tr> <td>enumeration</td> <td>2</td> <td></td> </tr> </tbody> </table>	Kind	Value	Annotation	enumeration	0		enumeration	1		enumeration	2	
Kind	Value	Annotation											
enumeration	0												
enumeration	1												
enumeration	2												
source	<pre><xs:simpleType name="PerfAckDualCreditCode"> <xs:restriction base="xs:token"> <xs:enumeration value="0"/> <xs:enumeration value="1"/> <xs:enumeration value="2"/> <!-- Student not acknowledged for Dual Credit --> <!-- Acknowledgment for Associates degree --> <!-- Acknowledgment for College credit hours --> </xs:restriction> </xs:simpleType></pre>												

simpleType **PerformanceLevelType**

namespace	urn:us:tx:state:tea:TREx:v1.16																																				
type	restriction of xs:token																																				
properties	base xs:token																																				
used by	element AssessmentType/PerformanceLevel																																				
facets	<table border="1"> <thead> <tr> <th>Kind</th> <th>Value</th> <th>Annotation</th> </tr> </thead> <tbody> <tr> <td>enumeration</td> <td>0</td> <td></td> </tr> <tr> <td>enumeration</td> <td>1</td> <td></td> </tr> <tr> <td>enumeration</td> <td>2</td> <td></td> </tr> <tr> <td>enumeration</td> <td>3</td> <td></td> </tr> <tr> <td>enumeration</td> <td>4</td> <td></td> </tr> <tr> <td>enumeration</td> <td>5</td> <td></td> </tr> <tr> <td>enumeration</td> <td>6</td> <td></td> </tr> <tr> <td>enumeration</td> <td>7</td> <td></td> </tr> <tr> <td>enumeration</td> <td>8</td> <td></td> </tr> <tr> <td>enumeration</td> <td>9</td> <td></td> </tr> <tr> <td>enumeration</td> <td>A</td> <td></td> </tr> </tbody> </table>	Kind	Value	Annotation	enumeration	0		enumeration	1		enumeration	2		enumeration	3		enumeration	4		enumeration	5		enumeration	6		enumeration	7		enumeration	8		enumeration	9		enumeration	A	
Kind	Value	Annotation																																			
enumeration	0																																				
enumeration	1																																				
enumeration	2																																				
enumeration	3																																				
enumeration	4																																				
enumeration	5																																				
enumeration	6																																				
enumeration	7																																				
enumeration	8																																				
enumeration	9																																				
enumeration	A																																				
source	<pre><xs:simpleType name="PerformanceLevelType"> <xs:restriction base="xs:token"> <xs:enumeration value="0"/> <xs:enumeration value="1"/> <xs:enumeration value="2"/> <xs:enumeration value="3"/> <xs:enumeration value="4"/> <xs:enumeration value="5"/> </xs:restriction> </xs:simpleType></pre>																																				

	<pre> <xs:enumeration value="6"/> <xs:enumeration value="7"/> <xs:enumeration value="8"/> <xs:enumeration value="9"/> <xs:enumeration value="A"/> <!-- NA - Not Applicable --> <!-- I - Developing or Unsatisfactory Academic Performance, Level I --> <!-- II - Satisfactory Academic Performance, Level II --> <!-- III - Accomplished or Advanced Academic Performance, Level III --> <!-- M - Met Transition Rule Standard --> <!-- SI - Substitute Assessment, Level I --> <!-- SII - Substitute Assessment, Level II --> <!-- DidNotMeet - Unsatisfactory Academic Performance, Level I (STAAR Alternate) or Did Not Meet Grade Level Performance --> <!-- Approaches - Approaches Grade Level Performance (Not available for use for STAAR Alternate) --> <!-- Meets - Satisfactory Academic Performance, Level II (STAAR Alternate) or Meets Grade Level Performance --> <!-- Masters - Accomplished or Advanced Academic Performance, Level III (STAAR Alternate) or Masters Grade Level Performance --> </xs:restriction> </xs:simpleType> </pre>
--	---

simpleType **PhoneNumberType**

namespace	urn:us:tx:state:tea:TREx:v1.16									
type	restriction of xs:token									
properties	base xs:token									
used by	elements PhoneNumberGroup/Fax PhoneNumberGroup/PhoneNumber									
facets	<table border="1"> <thead> <tr> <th>Kind</th> <th>Value</th> <th>Annotation</th> </tr> </thead> <tbody> <tr> <td>minLength</td> <td>1</td> <td></td> </tr> <tr> <td>maxLength</td> <td>20</td> <td></td> </tr> </tbody> </table>	Kind	Value	Annotation	minLength	1		maxLength	20	
Kind	Value	Annotation								
minLength	1									
maxLength	20									
source	<pre> <xs:simpleType name="PhoneNumberType"> <xs:restriction base="xs:token"> <xs:minLength value="1"/> <xs:maxLength value="20"/> </xs:restriction> </xs:simpleType> </pre>									

simpleType **PostalCodeType**

namespace	urn:us:tx:state:tea:TREx:v1.16						
type	restriction of xs:token						
properties	base xs:token						
used by	element AddressType/PostalCode						
facets	<table border="1"> <thead> <tr> <th>Kind</th> <th>Value</th> <th>Annotation</th> </tr> </thead> <tbody> <tr> <td>minLength</td> <td>5</td> <td></td> </tr> </tbody> </table>	Kind	Value	Annotation	minLength	5	
Kind	Value	Annotation					
minLength	5						

	maxLength 10 pattern (([0-9]{5}) ([0-9]{5}-[0-9]{4}))
source	<pre><xs:simpleType name="PostalCodeType"> <xs:restriction base="xs:token"> <xs:minLength value="5"/> <xs:maxLength value="10"/> <xs:pattern value="([0-9]{5}) ([0-9]{5}-[0-9]{4})"/> </xs:restriction> </xs:simpleType></pre>

simpleType **PriorIDType**

namespace	urn:us:tx:state:tea:TREx:v1.16									
type	restriction of xs:token									
properties	base xs:token									
used by	element StudentIdentificationType/PriorID									
facets	<table border="1"> <thead> <tr> <th>Kind</th> <th>Value</th> <th>Annotation</th> </tr> </thead> <tbody> <tr> <td>minLength</td> <td>1</td> <td></td> </tr> <tr> <td>maxLength</td> <td>9</td> <td></td> </tr> </tbody> </table>	Kind	Value	Annotation	minLength	1		maxLength	9	
Kind	Value	Annotation								
minLength	1									
maxLength	9									
source	<pre><xs:simpleType name="PriorIDType"> <xs:restriction base="xs:token"> <xs:minLength value="1"/> <xs:maxLength value="9"/> </xs:restriction> </xs:simpleType></pre>									

simpleType **QuartileType**

namespace	urn:us:tx:state:tea:TREx:v1.16															
type	restriction of xs:token															
properties	base xs:token															
used by	element AcademicSummaryType/Quartile															
facets	<table border="1"> <thead> <tr> <th>Kind</th> <th>Value</th> <th>Annotation</th> </tr> </thead> <tbody> <tr> <td>enumeration</td> <td>1</td> <td></td> </tr> <tr> <td>enumeration</td> <td>2</td> <td></td> </tr> <tr> <td>enumeration</td> <td>3</td> <td></td> </tr> <tr> <td>enumeration</td> <td>4</td> <td></td> </tr> </tbody> </table>	Kind	Value	Annotation	enumeration	1		enumeration	2		enumeration	3		enumeration	4	
Kind	Value	Annotation														
enumeration	1															
enumeration	2															
enumeration	3															
enumeration	4															
source	<pre><xs:simpleType name="QuartileType"> <xs:restriction base="xs:token"> <xs:enumeration value="1"/> <xs:enumeration value="2"/> <xs:enumeration value="3"/> <xs:enumeration value="4"/> <!-- Student is ranked in the top 25% (1-25%) of the graduating class. --> <!-- Student is ranked in the top 50% (26-50%) of the graduating class. --> <!-- Student is ranked in the top 75% (51-75%) of the graduating class. --> </xs:restriction> </xs:simpleType></pre>															

	<pre> <!-- Student is ranked in the lowest 25% (below 75%) of the graduating class. --> </xs:restriction> </xs:simpleType> </pre>
--	---

simpleType **RaceType**

namespace	urn:us:tx:state:tea:TREx:v1.16																		
type	restriction of xs:token																		
properties	base xs:token																		
used by	element StudentDemographicType/Race																		
facets	<table border="1"> <thead> <tr> <th>Kind</th> <th>Value</th> <th>Annotation</th> </tr> </thead> <tbody> <tr> <td>enumeration</td> <td>1</td> <td></td> </tr> <tr> <td>enumeration</td> <td>2</td> <td></td> </tr> <tr> <td>enumeration</td> <td>3</td> <td></td> </tr> <tr> <td>enumeration</td> <td>4</td> <td></td> </tr> <tr> <td>enumeration</td> <td>5</td> <td></td> </tr> </tbody> </table>	Kind	Value	Annotation	enumeration	1		enumeration	2		enumeration	3		enumeration	4		enumeration	5	
Kind	Value	Annotation																	
enumeration	1																		
enumeration	2																		
enumeration	3																		
enumeration	4																		
enumeration	5																		
source	<pre> <xs:simpleType name="RaceType"> <xs:restriction base="xs:token"> <xs:enumeration value="1"/> <xs:enumeration value="2"/> <xs:enumeration value="3"/> <xs:enumeration value="4"/> <xs:enumeration value="5"/> <!-- American Indian or Alaskan Native --> <!-- Asian or Pacific Islander --> <!-- Black, not of Hispanic origin --> <!-- Hispanic --> <!-- White, not of Hispanic origin --> </xs:restriction> </xs:simpleType> </pre>																		

simpleType **SchoolIDType**

namespace	urn:us:tx:state:tea:TREx:v1.16						
type	restriction of xs:token						
properties	base xs:token						
used by	elements CourseType/CreditCampus SchoolType/SchoolID						
facets	<table border="1"> <thead> <tr> <th>Kind</th> <th>Value</th> <th>Annotation</th> </tr> </thead> <tbody> <tr> <td>pattern</td> <td>([0-9]{9})</td> <td></td> </tr> </tbody> </table>	Kind	Value	Annotation	pattern	([0-9]{9})	
Kind	Value	Annotation					
pattern	([0-9]{9})						
source	<pre> <xs:simpleType name="SchoolIDType"> <xs:restriction base="xs:token"> <xs:pattern value="([0-9]{9})"/> </xs:restriction> </xs:simpleType> </pre>						

simpleType **SchoolNameType**

namespace	urn:us:tx:state:tea:TREx:v1.16									
type	restriction of xs:token									
properties	base xs:token									
used by	element SchoolType/SchoolName									
facets	<table border="1"> <thead> <tr> <th>Kind</th> <th>Value</th> <th>Annotation</th> </tr> </thead> <tbody> <tr> <td>minLength</td> <td>1</td> <td></td> </tr> <tr> <td>maxLength</td> <td>34</td> <td></td> </tr> </tbody> </table>	Kind	Value	Annotation	minLength	1		maxLength	34	
Kind	Value	Annotation								
minLength	1									
maxLength	34									
source	<pre><xs:simpleType name="SchoolNameType"> <xs:restriction base="xs:token"> <xs:minLength value="1"/> <xs:maxLength value="34"/> </xs:restriction> </xs:simpleType></pre>									

simpleType **SemesterSeqType**

namespace	urn:us:tx:state:tea:TREx:v1.16																																				
type	restriction of xs:token																																				
properties	base xs:token																																				
used by	element CourseType/SemesterSeq																																				
facets	<table border="1"> <thead> <tr> <th>Kind</th> <th>Value</th> <th>Annotation</th> </tr> </thead> <tbody> <tr><td>enumeration</td><td>0</td><td></td></tr> <tr><td>enumeration</td><td>1</td><td></td></tr> <tr><td>enumeration</td><td>2</td><td></td></tr> <tr><td>enumeration</td><td>3</td><td></td></tr> <tr><td>enumeration</td><td>4</td><td></td></tr> <tr><td>enumeration</td><td>5</td><td></td></tr> <tr><td>enumeration</td><td>6</td><td></td></tr> <tr><td>enumeration</td><td>7</td><td></td></tr> <tr><td>enumeration</td><td>8</td><td></td></tr> <tr><td>enumeration</td><td>9</td><td></td></tr> <tr><td>enumeration</td><td>A</td><td></td></tr> </tbody> </table>	Kind	Value	Annotation	enumeration	0		enumeration	1		enumeration	2		enumeration	3		enumeration	4		enumeration	5		enumeration	6		enumeration	7		enumeration	8		enumeration	9		enumeration	A	
Kind	Value	Annotation																																			
enumeration	0																																				
enumeration	1																																				
enumeration	2																																				
enumeration	3																																				
enumeration	4																																				
enumeration	5																																				
enumeration	6																																				
enumeration	7																																				
enumeration	8																																				
enumeration	9																																				
enumeration	A																																				
source	<pre><xs:simpleType name="SemesterSeqType"> <xs:restriction base="xs:token"> <xs:enumeration value="0"/> <xs:enumeration value="1"/> <xs:enumeration value="2"/> <xs:enumeration value="3"/> <xs:enumeration value="4"/> <xs:enumeration value="5"/> <xs:enumeration value="6"/> <xs:enumeration value="7"/> <xs:enumeration value="8"/> <xs:enumeration value="9"/> </xs:restriction> </xs:simpleType></pre>																																				

	<pre> <xs:enumeration value="A"/> <!-- One semester course --> <!-- First half of a two-semester course --> <!-- Second half of a two-semester course --> <!-- First third of a three-semester course --> <!-- Second third of a three-semester course --> <!-- Last third of a three-semester course --> <!-- First fourth of a four-semester course --> <!-- Second fourth of a four-semester course --> <!-- Third fourth of a four-semester course --> <!-- Last fourth of a four-semester course --> <!-- Non-High School Year Long Course --> </xs:restriction> </xs:simpleType> </pre>
--	---

simpleType **SemesterType**

namespace	urn:us:tx:state:tea:TREx:v1.16						
type	restriction of xs:integer						
properties	base xs:integer						
used by	element CourseType/Semester						
facets	<table border="1"> <thead> <tr> <th>Kind</th> <th>Value</th> <th>Annotation</th> </tr> </thead> <tbody> <tr> <td>totalDigits</td> <td>1</td> <td></td> </tr> </tbody> </table>	Kind	Value	Annotation	totalDigits	1	
Kind	Value	Annotation					
totalDigits	1						
source	<pre> <xs:simpleType name="SemesterType"> <xs:restriction base="xs:integer"> <xs:totalDigits value="1"/> </xs:restriction> </xs:simpleType> </pre>						

simpleType **SessionTypeType**

namespace	urn:us:tx:state:tea:TREx:v1.16												
type	restriction of xs:token												
properties	base xs:token												
used by	elements AcademicSessionType/SessionType CurrentCourseworkType/SessionType												
facets	<table border="1"> <thead> <tr> <th>Kind</th> <th>Value</th> <th>Annotation</th> </tr> </thead> <tbody> <tr> <td>enumeration</td> <td>Semester</td> <td></td> </tr> <tr> <td>enumeration</td> <td>Trimester</td> <td></td> </tr> <tr> <td>enumeration</td> <td>Quarter</td> <td></td> </tr> </tbody> </table>	Kind	Value	Annotation	enumeration	Semester		enumeration	Trimester		enumeration	Quarter	
Kind	Value	Annotation											
enumeration	Semester												
enumeration	Trimester												
enumeration	Quarter												
source	<pre> <xs:simpleType name="SessionTypeType"> <xs:restriction base="xs:token"> <xs:enumeration value="Semester"/> <xs:enumeration value="Trimester"/> <xs:enumeration value="Quarter"/> </xs:restriction> </xs:simpleType> </pre>												

simpleType **StateProvinceType**

namespace	urn:us:tx:state:tea:TReX:v1.16		
type	restriction of xs:token		
properties	base xs:token		
used by	element AddressType/StateProvince		
facets	Kind	Value	Annotation
	enumeration	TX	
	enumeration	AA	
	enumeration	AB	
	enumeration	AE	
	enumeration	AK	
	enumeration	AL	
	enumeration	AP	
	enumeration	AR	
	enumeration	AS	
	enumeration	AZ	
	enumeration	BC	
	enumeration	CA	
	enumeration	CO	
	enumeration	CT	
	enumeration	CZ	
	enumeration	DC	
	enumeration	DE	
	enumeration	FL	
	enumeration	FM	
	enumeration	GA	
	enumeration	GU	
	enumeration	HI	
	enumeration	IA	
	enumeration	ID	
	enumeration	IL	
	enumeration	IN	
	enumeration	KS	
	enumeration	KY	
	enumeration	LA	
	enumeration	MA	
	enumeration	MB	
	enumeration	MD	
	enumeration	ME	
	enumeration	MH	
	enumeration	MI	
	enumeration	MN	

	enumeration MO enumeration MP enumeration MS enumeration MT enumeration NB enumeration NC enumeration ND enumeration NE enumeration NF enumeration NH enumeration NJ enumeration NL enumeration NM enumeration NS enumeration NT enumeration NU enumeration NV enumeration NY enumeration OH enumeration OK enumeration ON enumeration OR enumeration PA enumeration PE enumeration PR enumeration PW enumeration QC enumeration RI enumeration SC enumeration SD enumeration SK enumeration TN enumeration UT enumeration VA enumeration VI enumeration VT enumeration WA enumeration WI enumeration WV enumeration WY enumeration YT
source	<pre> <xs:simpleType name="StateProvinceType"> <xs:restriction base="xs:token"> <xs:enumeration value="TX"/> <xs:enumeration value="AA"/> <xs:enumeration value="AB"/> </xs:restriction> </xs:simpleType> </pre>

```
<xs:enumeration value="AE"/>  
<xs:enumeration value="AK"/>  
<xs:enumeration value="AL"/>  
<xs:enumeration value="AP"/>  
<xs:enumeration value="AR"/>  
<xs:enumeration value="AS"/>  
<xs:enumeration value="AZ"/>  
<xs:enumeration value="BC"/>  
<xs:enumeration value="CA"/>  
<xs:enumeration value="CO"/>  
<xs:enumeration value="CT"/>  
<xs:enumeration value="CZ"/>  
<xs:enumeration value="DC"/>  
<xs:enumeration value="DE"/>  
<xs:enumeration value="FL"/>  
<xs:enumeration value="FM"/>  
<xs:enumeration value="GA"/>  
<xs:enumeration value="GU"/>  
<xs:enumeration value="HI"/>  
<xs:enumeration value="IA"/>  
<xs:enumeration value="ID"/>  
<xs:enumeration value="IL"/>  
<xs:enumeration value="IN"/>  
<xs:enumeration value="KS"/>  
<xs:enumeration value="KY"/>  
<xs:enumeration value="LA"/>  
<xs:enumeration value="MA"/>  
<xs:enumeration value="MB"/>  
<xs:enumeration value="MD"/>  
<xs:enumeration value="ME"/>  
<xs:enumeration value="MH"/>  
<xs:enumeration value="MI"/>  
<xs:enumeration value="MN"/>  
<xs:enumeration value="MO"/>  
<xs:enumeration value="MP"/>  
<xs:enumeration value="MS"/>  
<xs:enumeration value="MT"/>  
<xs:enumeration value="NB"/>  
<xs:enumeration value="NC"/>  
<xs:enumeration value="ND"/>  
<xs:enumeration value="NE"/>  
<xs:enumeration value="NF"/>  
<xs:enumeration value="NH"/>  
<xs:enumeration value="NJ"/>  
<xs:enumeration value="NL"/>  
<xs:enumeration value="NM"/>  
<xs:enumeration value="NS"/>  
<xs:enumeration value="NT"/>  
<xs:enumeration value="NU"/>  
<xs:enumeration value="NV"/>  
<xs:enumeration value="NY"/>  
<xs:enumeration value="OH"/>  
<xs:enumeration value="OK"/>  
<xs:enumeration value="ON"/>  
<xs:enumeration value="OR"/>
```



```
<xs:enumeration value="PA"/>
<xs:enumeration value="PE"/>
<xs:enumeration value="PR"/>
<xs:enumeration value="PW"/>
<xs:enumeration value="QC"/>
<xs:enumeration value="RI"/>
<xs:enumeration value="SC"/>
<xs:enumeration value="SD"/>
<xs:enumeration value="SK"/>
<xs:enumeration value="TN"/>
<xs:enumeration value="UT"/>
<xs:enumeration value="VA"/>
<xs:enumeration value="VI"/>
<xs:enumeration value="VT"/>
<xs:enumeration value="WA"/>
<xs:enumeration value="WI"/>
<xs:enumeration value="WV"/>
<xs:enumeration value="WY"/>
<xs:enumeration value="YT"/>
<!-- Texas -->
<!-- Military-Americas -->
<!-- Alberta -->
<!-- Military-Europe -->
<!-- Alaska -->
<!-- Alabama -->
<!-- Military-Pacific -->
<!-- Arkansas -->
<!-- American Samoa -->
<!-- Arizona -->
<!-- British Columbia -->
<!-- California -->
<!-- Colorado -->
<!-- Connecticut -->
<!-- Canal Zone -->
<!-- District Of Columbia -->
<!-- Delaware -->
<!-- Florida -->
<!-- Federated States Of Micronesia -->
<!-- Georgia -->
<!-- Guam -->
<!-- Hawaii -->
<!-- Iowa -->
<!-- Idaho -->
<!-- Illinois -->
<!-- Indiana -->
<!-- Kansas -->
<!-- Kentucky -->
<!-- Louisiana -->
<!-- Massachusetts -->
<!-- Manitoba -->
<!-- Maryland -->
<!-- Maine -->
<!-- Marshall Islands -->
<!-- Michigan -->
<!-- Minnesota -->
```

	<pre> <!-- Missouri --> <!-- Northern Mariana Islands --> <!-- Mississippi --> <!-- Montana --> <!-- New Brunswick --> <!-- North Carolina --> <!-- North Dakota --> <!-- Nebraska --> <!-- Newfoundland --> <!-- New Hampshire --> <!-- New Jersey --> <!-- Newfoundland And Labrador --> <!-- New Mexico --> <!-- Nova Scotia --> <!-- Northwest Territories --> <!-- Nunavut --> <!-- Nevada --> <!-- New York --> <!-- Ohio --> <!-- Oklahoma --> <!-- Ontario --> <!-- Oregon --> <!-- Pennsylvania --> <!-- Prince Edward Island --> <!-- Puerto Rico --> <!-- Republic Of Palau --> <!-- Quebec --> <!-- Rhode Island --> <!-- South Carolina --> <!-- South Dakota --> <!-- Saskatchewan --> <!-- Tennessee --> <!-- Utah --> <!-- Virginia --> <!-- Virgin Islands --> <!-- Vermont --> <!-- Washington --> <!-- Wisconsin --> <!-- West Virginia --> <!-- Wyoming --> <!-- Yukon --> </xs:restriction> </xs:simpleType> </pre>
--	--

simpleType **StudentIDType**

namespace	urn:us:tx:state:tea:TREx:v1.16
type	restriction of xs:token
properties	base xs:token
used by	element StudentIdentificationType/StudentID
facets	Kind Value Annotation

	minLength 1 maxLength 64
source	<pre><xs:simpleType name="StudentIDType"> <xs:restriction base="xs:token"> <xs:minLength value="1"/> <xs:maxLength value="64"/> </xs:restriction> </xs:simpleType></pre>

simpleType **StudentUniqueIDType**

namespace	urn:us:tx:state:tea:TREx:v1.16						
type	restriction of xs:token						
properties	base xs:token						
used by	element StudentIdentificationType/StudentUniqueID						
facets	<table border="1"> <thead> <tr> <th>Kind</th> <th>Value</th> <th>Annotation</th> </tr> </thead> <tbody> <tr> <td>pattern</td> <td>[0-9]{10}</td> <td></td> </tr> </tbody> </table>	Kind	Value	Annotation	pattern	[0-9]{10}	
Kind	Value	Annotation					
pattern	[0-9]{10}						
source	<pre><xs:simpleType name="StudentUniqueIDType"> <xs:restriction base="xs:token"> <xs:pattern value="[0-9]{10}"/> </xs:restriction> </xs:simpleType></pre>						

simpleType **SubjectAreaType**

namespace	urn:us:tx:state:tea:TREx:v1.16																																													
type	restriction of xs:token																																													
properties	base xs:token																																													
used by	element CourseType/SubjectArea																																													
facets	<table border="1"> <thead> <tr> <th>Kind</th> <th>Value</th> <th>Annotation</th> </tr> </thead> <tbody> <tr><td>enumeration</td><td>ELA</td><td></td></tr> <tr><td>enumeration</td><td>SP</td><td></td></tr> <tr><td>enumeration</td><td>MA</td><td></td></tr> <tr><td>enumeration</td><td>SC</td><td></td></tr> <tr><td>enumeration</td><td>SS</td><td></td></tr> <tr><td>enumeration</td><td>ECFE</td><td></td></tr> <tr><td>enumeration</td><td>HL</td><td></td></tr> <tr><td>enumeration</td><td>PE</td><td></td></tr> <tr><td>enumeration</td><td>LOTE</td><td></td></tr> <tr><td>enumeration</td><td>FA</td><td></td></tr> <tr><td>enumeration</td><td>TA</td><td></td></tr> <tr><td>enumeration</td><td>CTE</td><td></td></tr> <tr><td>enumeration</td><td>EL</td><td></td></tr> <tr><td>enumeration</td><td>LC</td><td></td></tr> </tbody> </table>	Kind	Value	Annotation	enumeration	ELA		enumeration	SP		enumeration	MA		enumeration	SC		enumeration	SS		enumeration	ECFE		enumeration	HL		enumeration	PE		enumeration	LOTE		enumeration	FA		enumeration	TA		enumeration	CTE		enumeration	EL		enumeration	LC	
Kind	Value	Annotation																																												
enumeration	ELA																																													
enumeration	SP																																													
enumeration	MA																																													
enumeration	SC																																													
enumeration	SS																																													
enumeration	ECFE																																													
enumeration	HL																																													
enumeration	PE																																													
enumeration	LOTE																																													
enumeration	FA																																													
enumeration	TA																																													
enumeration	CTE																																													
enumeration	EL																																													
enumeration	LC																																													

source	<pre> <xs:simpleType name="SubjectAreaType"> <xs:restriction base="xs:token"> <xs:enumeration value="ELA"/> <xs:enumeration value="SP"/> <xs:enumeration value="MA"/> <xs:enumeration value="SC"/> <xs:enumeration value="SS"/> <xs:enumeration value="ECFE"/> <xs:enumeration value="HL"/> <xs:enumeration value="PE"/> <xs:enumeration value="LOTE"/> <xs:enumeration value="FA"/> <xs:enumeration value="TA"/> <xs:enumeration value="CTE"/> <xs:enumeration value="EL"/> <xs:enumeration value="LC"/> <!-- English Language Arts --> <!-- Speech --> <!-- Mathematics --> <!-- Science --> <!-- Social Studies --> <!-- Economics/Free Enterprise --> <!-- Health --> <!-- Physical Education or equivalent --> <!-- Language Other Than English --> <!-- Fine Arts --> <!-- Tech Applications --> <!-- Career and Technical Education --> <!-- Other Electives --> <!-- Local Credit --> </xs:restriction> </xs:simpleType> </pre>
--------	---

simpleType **SubTestNameType**

namespace	urn:us:tx:state:tea:TREx:v1.16									
type	restriction of xs:token									
properties	base xs:token									
used by	element AssessmentSubTestType/SubTestName									
facets	<table border="1"> <thead> <tr> <th>Kind</th> <th>Value</th> <th>Annotation</th> </tr> </thead> <tbody> <tr> <td>minLength</td> <td>1</td> <td></td> </tr> <tr> <td>maxLength</td> <td>60</td> <td></td> </tr> </tbody> </table>	Kind	Value	Annotation	minLength	1		maxLength	60	
Kind	Value	Annotation								
minLength	1									
maxLength	60									
source	<pre> <xs:simpleType name="SubTestNameType"> <xs:restriction base="xs:token"> <xs:minLength value="1"/> <xs:maxLength value="60"/> </xs:restriction> </xs:simpleType> </pre>									

simpleType **SuffixType**

namespace	urn:us:tx:state:tea:TREx:v1.16																																							
type	restriction of xs:token																																							
properties	base xs:token																																							
used by	element PersonNameType/Suffix																																							
facets	<table border="1"> <thead> <tr> <th>Kind</th> <th>Value</th> <th>Annotation</th> </tr> </thead> <tbody> <tr><td>enumeration</td><td>1</td><td></td></tr> <tr><td>enumeration</td><td>2</td><td></td></tr> <tr><td>enumeration</td><td>3</td><td></td></tr> <tr><td>enumeration</td><td>4</td><td></td></tr> <tr><td>enumeration</td><td>5</td><td></td></tr> <tr><td>enumeration</td><td>6</td><td></td></tr> <tr><td>enumeration</td><td>7</td><td></td></tr> <tr><td>enumeration</td><td>8</td><td></td></tr> <tr><td>enumeration</td><td>9</td><td></td></tr> <tr><td>enumeration</td><td>A</td><td></td></tr> <tr><td>enumeration</td><td>B</td><td></td></tr> <tr><td>enumeration</td><td>C</td><td></td></tr> </tbody> </table>	Kind	Value	Annotation	enumeration	1		enumeration	2		enumeration	3		enumeration	4		enumeration	5		enumeration	6		enumeration	7		enumeration	8		enumeration	9		enumeration	A		enumeration	B		enumeration	C	
Kind	Value	Annotation																																						
enumeration	1																																							
enumeration	2																																							
enumeration	3																																							
enumeration	4																																							
enumeration	5																																							
enumeration	6																																							
enumeration	7																																							
enumeration	8																																							
enumeration	9																																							
enumeration	A																																							
enumeration	B																																							
enumeration	C																																							
source	<pre> <xs:simpleType name="SuffixType"> <xs:restriction base="xs:token"> <xs:enumeration value="1"/> <xs:enumeration value="2"/> <xs:enumeration value="3"/> <xs:enumeration value="4"/> <xs:enumeration value="5"/> <xs:enumeration value="6"/> <xs:enumeration value="7"/> <xs:enumeration value="8"/> <xs:enumeration value="9"/> <xs:enumeration value="A"/> <xs:enumeration value="B"/> <xs:enumeration value="C"/> <!-- Jr. --> <!-- Sr. --> <!-- II --> <!-- III --> <!-- IV --> <!-- V --> <!-- VI --> <!-- VII --> <!-- VIII --> <!-- I --> <!-- IX --> <!-- X --> </xs:restriction> </xs:simpleType> </pre>																																							

simpleType **TestCodeType**

namespace	urn:us:tx:state:tea:TREx:v1.16																																																																		
type	restriction of xs:token																																																																		
properties	base xs:token																																																																		
used by	element AssessmentType/TestCode																																																																		
facets	<table border="1"> <thead> <tr> <th>Kind</th> <th>Value</th> <th>Annotation</th> </tr> </thead> <tbody> <tr><td>enumeration</td><td>A</td><td></td></tr> <tr><td>enumeration</td><td>B</td><td></td></tr> <tr><td>enumeration</td><td>C</td><td></td></tr> <tr><td>enumeration</td><td>D</td><td></td></tr> <tr><td>enumeration</td><td>E</td><td></td></tr> <tr><td>enumeration</td><td>G</td><td></td></tr> <tr><td>enumeration</td><td>I</td><td></td></tr> <tr><td>enumeration</td><td>L</td><td></td></tr> <tr><td>enumeration</td><td>M</td><td></td></tr> <tr><td>enumeration</td><td>N</td><td></td></tr> <tr><td>enumeration</td><td>O</td><td></td></tr> <tr><td>enumeration</td><td>P</td><td></td></tr> <tr><td>enumeration</td><td>Q</td><td></td></tr> <tr><td>enumeration</td><td>R</td><td></td></tr> <tr><td>enumeration</td><td>S</td><td></td></tr> <tr><td>enumeration</td><td>T</td><td></td></tr> <tr><td>enumeration</td><td>W</td><td></td></tr> <tr><td>enumeration</td><td>X</td><td></td></tr> <tr><td>enumeration</td><td>Y</td><td></td></tr> <tr><td>enumeration</td><td>Z</td><td></td></tr> <tr><td>enumeration</td><td>*</td><td></td></tr> </tbody> </table>	Kind	Value	Annotation	enumeration	A		enumeration	B		enumeration	C		enumeration	D		enumeration	E		enumeration	G		enumeration	I		enumeration	L		enumeration	M		enumeration	N		enumeration	O		enumeration	P		enumeration	Q		enumeration	R		enumeration	S		enumeration	T		enumeration	W		enumeration	X		enumeration	Y		enumeration	Z		enumeration	*	
Kind	Value	Annotation																																																																	
enumeration	A																																																																		
enumeration	B																																																																		
enumeration	C																																																																		
enumeration	D																																																																		
enumeration	E																																																																		
enumeration	G																																																																		
enumeration	I																																																																		
enumeration	L																																																																		
enumeration	M																																																																		
enumeration	N																																																																		
enumeration	O																																																																		
enumeration	P																																																																		
enumeration	Q																																																																		
enumeration	R																																																																		
enumeration	S																																																																		
enumeration	T																																																																		
enumeration	W																																																																		
enumeration	X																																																																		
enumeration	Y																																																																		
enumeration	Z																																																																		
enumeration	*																																																																		
source	<pre> <xs:simpleType name="TestCodeType"> <xs:restriction base="xs:token"> <xs:enumeration value="A"/> <xs:enumeration value="B"/> <xs:enumeration value="C"/> <xs:enumeration value="D"/> <xs:enumeration value="E"/> <xs:enumeration value="G"/> <xs:enumeration value="I"/> <xs:enumeration value="L"/> <xs:enumeration value="M"/> <xs:enumeration value="N"/> <xs:enumeration value="O"/> <xs:enumeration value="P"/> <xs:enumeration value="Q"/> <xs:enumeration value="R"/> <xs:enumeration value="S"/> <xs:enumeration value="T"/> <xs:enumeration value="W"/> <xs:enumeration value="X"/> <xs:enumeration value="Y"/> </pre>																																																																		

```

<xs:enumeration value="Z"/>
<xs:enumeration value="*/>
<!-- Absent -->
<!-- Score code defaulted to B (Reading, grades K-1) -->
<!-- Student did not take paper-version reading test and an online-version
reading test for student could not be matched to paper-version record. -->
<!-- No information available for this subject -->
<!-- Extenuating Circumstances, do not score (Reading, grades K-1) -->
<!-- Student Information provided from TAKS-Alt -->
<!-- TAKS Inclusive test was administered -->
<!-- Student is LEP-exempt -->
<!-- Medical Exception -->
<!-- No Authentic Academic Response -->
<!-- Other -->
<!-- Previously Met Standards -->
<!-- Student did not take TAKS Reading test; do not score -->
<!-- ARD Committee determined TAKS Reading is not appropriate for student --
>
<!-- Student Test was Scored -->
<!-- State-approved alternate assessment administered instead of TAKS
Reading -->
<!-- Parental Waiver -->
<!-- Student is ARD-exempt; do not score -->
<!-- Student did not take English-version Reading test; do not score -->
<!-- Student did not take Spanish-version Reading test; do not score -->
<!-- No information available for this subject -->
</xs:restriction>
</xs:simpleType>

```

simpleType **TestNameType**

namespace	urn:us:tx:state:tea:TREx:v1.16																																										
type	restriction of xs:token																																										
properties	base xs:token																																										
used by	element AssessmentType/TestName																																										
facets	<table border="1"> <thead> <tr> <th>Kind</th> <th>Value</th> <th>Annotation</th> </tr> </thead> <tbody> <tr><td>enumeration</td><td>01</td><td></td></tr> <tr><td>enumeration</td><td>02</td><td></td></tr> <tr><td>enumeration</td><td>03</td><td></td></tr> <tr><td>enumeration</td><td>04</td><td></td></tr> <tr><td>enumeration</td><td>05</td><td></td></tr> <tr><td>enumeration</td><td>06</td><td></td></tr> <tr><td>enumeration</td><td>07</td><td></td></tr> <tr><td>enumeration</td><td>08</td><td></td></tr> <tr><td>enumeration</td><td>09</td><td></td></tr> <tr><td>enumeration</td><td>10</td><td></td></tr> <tr><td>enumeration</td><td>11</td><td></td></tr> <tr><td>enumeration</td><td>12</td><td></td></tr> <tr><td>enumeration</td><td>13</td><td></td></tr> </tbody> </table>	Kind	Value	Annotation	enumeration	01		enumeration	02		enumeration	03		enumeration	04		enumeration	05		enumeration	06		enumeration	07		enumeration	08		enumeration	09		enumeration	10		enumeration	11		enumeration	12		enumeration	13	
Kind	Value	Annotation																																									
enumeration	01																																										
enumeration	02																																										
enumeration	03																																										
enumeration	04																																										
enumeration	05																																										
enumeration	06																																										
enumeration	07																																										
enumeration	08																																										
enumeration	09																																										
enumeration	10																																										
enumeration	11																																										
enumeration	12																																										
enumeration	13																																										

enumeration	14	
enumeration	15	
enumeration	16	
enumeration	17	
enumeration	18	
enumeration	19	
enumeration	20	
enumeration	21	
enumeration	22	
enumeration	23	
enumeration	24	
enumeration	25	
enumeration	26	
enumeration	27	
enumeration	28	
enumeration	29	
enumeration	30	
enumeration	31	
enumeration	32	
enumeration	33	
enumeration	34	
enumeration	35	
enumeration	36	
enumeration	37	
enumeration	38	
enumeration	39	
enumeration	40	
enumeration	41	documentation Deprecated: Use code 'E6'
enumeration	42	documentation Deprecated: Use code 'E7'
enumeration	43	documentation Deprecated: Use code 'E9'
enumeration	44	documentation Deprecated: Use code 'EA'
enumeration	45	documentation Deprecated: Use code 'EC'
enumeration	46	documentation Deprecated: Use code 'EB'
enumeration	47	documentation Deprecated: Use code 'EF'
enumeration	48	documentation Deprecated: Use code 'H0'
enumeration	49	documentation Deprecated: Use code 'E8'
enumeration	50	documentation Deprecated: Use code 'H1'
enumeration	51	documentation Deprecated: Use code 'ED'
enumeration	52	documentation Deprecated: Use code 'H2'

enumeration	53	
enumeration	54	
enumeration	55	
enumeration	56	
enumeration	57	
enumeration	58	
enumeration	59	
enumeration	60	
enumeration	61	
enumeration	62	
enumeration	63	
enumeration	64	
enumeration	65	
enumeration	66	
enumeration	67	
enumeration	68	
enumeration	69	
enumeration	70	
enumeration	71	documentation Deprecated: Use code 'E0'
enumeration	72	documentation Deprecated: Use code 'E1'
enumeration	73	documentation Deprecated: Use code 'E2'
enumeration	74	documentation Deprecated: Use code 'E3'
enumeration	75	documentation Deprecated: Use code 'E4'
enumeration	76	documentation Deprecated: Use code 'E5'
enumeration	77	
enumeration	A0	
enumeration	A1	
enumeration	A2	
enumeration	A3	
enumeration	A4	
enumeration	A5	
enumeration	A6	
enumeration	A7	
enumeration	A8	
enumeration	A9	
enumeration	AA	
enumeration	AB	
enumeration	AC	
enumeration	AD	
enumeration	AE	
enumeration	AF	
enumeration	AG	

enumeration	AH
enumeration	AJ
enumeration	AK
enumeration	AL
enumeration	AM
enumeration	AN
enumeration	AP
enumeration	AQ
enumeration	B0
enumeration	B1
enumeration	B2
enumeration	B3
enumeration	B4
enumeration	B5
enumeration	B6
enumeration	B7
enumeration	B8
enumeration	C0
enumeration	C1
enumeration	C2
enumeration	C3
enumeration	C4
enumeration	C5
enumeration	C6
enumeration	C7
enumeration	C8
enumeration	C9
enumeration	CA
enumeration	CB
enumeration	CC
enumeration	CD
enumeration	CE
enumeration	CF
enumeration	CG
enumeration	D0
enumeration	D1
enumeration	D2
enumeration	D3
enumeration	D4
enumeration	D5
enumeration	D6
enumeration	D7
enumeration	D8
enumeration	D9
enumeration	DA

enumeration	DB	
enumeration	DC	
enumeration	DD	
enumeration	DE	
enumeration	DF	
enumeration	DG	
enumeration	E0	documentation Deprecated: Use code 'EG'
enumeration	E1	documentation Deprecated: Use code 'EG'
enumeration	E2	documentation Deprecated: Use code 'EH'
enumeration	E3	documentation Deprecated: Use code 'EH'
enumeration	E4	
enumeration	E5	
enumeration	E6	
enumeration	E7	
enumeration	E8	
enumeration	E9	
enumeration	EA	
enumeration	EB	
enumeration	EC	
enumeration	ED	
enumeration	EF	
enumeration	EG	
enumeration	EH	
enumeration	EJ	
enumeration	F0	
enumeration	F1	
enumeration	F2	
enumeration	F3	
enumeration	F4	
enumeration	F5	
enumeration	F6	
enumeration	F7	
enumeration	F8	
enumeration	G0	
enumeration	G1	
enumeration	G2	
enumeration	G3	
enumeration	G4	
enumeration	G5	
enumeration	G6	
enumeration	G7	
enumeration	G8	
enumeration	G9	

enumeration	GA
enumeration	GB
enumeration	GC
enumeration	GD
enumeration	H0
enumeration	H1
enumeration	H2
enumeration	H3
enumeration	H4
enumeration	H5
enumeration	H6
enumeration	H7
enumeration	H8
enumeration	J0
enumeration	J1
enumeration	J2
enumeration	J3
enumeration	J4
enumeration	JA
enumeration	JB
enumeration	JC
enumeration	JD
enumeration	JE
enumeration	JF
enumeration	JG
enumeration	JH
enumeration	JJ
enumeration	JK
enumeration	JL
enumeration	JM
enumeration	JN
enumeration	JP
enumeration	JQ
enumeration	JR
enumeration	JS
enumeration	K0
enumeration	K1
enumeration	K2
enumeration	K3
enumeration	K4
enumeration	KA
enumeration	KB
enumeration	KC
enumeration	KD
enumeration	KE

	enumeration KF enumeration KG enumeration KH enumeration KJ enumeration KK enumeration KL enumeration KM enumeration KN enumeration KP enumeration KQ enumeration KR enumeration KS
source	<pre> <xs:simpleType name="TestNameType"> <xs:restriction base="xs:token"> <xs:enumeration value="01"/> <xs:enumeration value="02"/> <xs:enumeration value="03"/> <xs:enumeration value="04"/> <xs:enumeration value="05"/> <xs:enumeration value="06"/> <xs:enumeration value="07"/> <xs:enumeration value="08"/> <xs:enumeration value="09"/> <xs:enumeration value="10"/> <xs:enumeration value="11"/> <xs:enumeration value="12"/> <xs:enumeration value="13"/> <xs:enumeration value="14"/> <xs:enumeration value="15"/> <xs:enumeration value="16"/> <xs:enumeration value="17"/> <xs:enumeration value="18"/> <xs:enumeration value="19"/> <xs:enumeration value="20"/> <xs:enumeration value="21"/> <xs:enumeration value="22"/> <xs:enumeration value="23"/> <xs:enumeration value="24"/> <xs:enumeration value="25"/> <xs:enumeration value="26"/> <xs:enumeration value="27"/> <xs:enumeration value="28"/> <xs:enumeration value="29"/> <xs:enumeration value="30"/> <xs:enumeration value="31"/> <xs:enumeration value="32"/> <xs:enumeration value="33"/> <xs:enumeration value="34"/> <xs:enumeration value="35"/> <xs:enumeration value="36"/> <xs:enumeration value="37"/> <xs:enumeration value="38"/> </pre>

	<pre> <xs:enumeration value="39"/> <xs:enumeration value="40"/> <xs:enumeration value="41"> <xs:annotation> <xs:documentation>Deprecated: Use code 'E6'</xs:documentation> </xs:annotation> <!-- EOC Algebra I --> </xs:enumeration> <xs:enumeration value="42"> <xs:annotation> <xs:documentation>Deprecated: Use code 'E7'</xs:documentation> </xs:annotation> <!-- EOC Geometry --> </xs:enumeration> <xs:enumeration value="43"> <xs:annotation> <xs:documentation>Deprecated: Use code 'E9'</xs:documentation> </xs:annotation> <!-- EOC Biology --> </xs:enumeration> <xs:enumeration value="44"> <xs:annotation> <xs:documentation>Deprecated: Use code 'EA'</xs:documentation> </xs:annotation> <!-- EOC Chemistry --> </xs:enumeration> <xs:enumeration value="45"> <xs:annotation> <xs:documentation>Deprecated: Use code 'EC'</xs:documentation> </xs:annotation> <!-- EOC U.S.History --> </xs:enumeration> <xs:enumeration value="46"> <xs:annotation> <xs:documentation>Deprecated: Use code 'EB'</xs:documentation> </xs:annotation> <!-- EOC Physics --> </xs:enumeration> <xs:enumeration value="47"> <xs:annotation> <xs:documentation>Deprecated: Use code 'EF'</xs:documentation> </xs:annotation> <!-- EOC World Geography --> </xs:enumeration> <xs:enumeration value="48"> <xs:annotation> <xs:documentation>Deprecated: Use code 'H0'</xs:documentation> </xs:annotation> <!-- EOC English I --> </xs:enumeration> <xs:enumeration value="49"> <xs:annotation> <xs:documentation>Deprecated: Use code 'E8'</xs:documentation> </xs:annotation> <!-- EOC Algebra II --> </pre>
--	---

```
</xs:enumeration>
<xs:enumeration value="50">
  <xs:annotation>
    <xs:documentation>Deprecated: Use code 'H1'</xs:documentation>
  </xs:annotation>
  <!-- EOC English II -->
</xs:enumeration>
<xs:enumeration value="51">
  <xs:annotation>
    <xs:documentation>Deprecated: Use code 'ED'</xs:documentation>
  </xs:annotation>
  <!-- EOC World History -->
</xs:enumeration>
<xs:enumeration value="52">
  <xs:annotation>
    <xs:documentation>Deprecated: Use code 'H2'</xs:documentation>
  </xs:annotation>
  <!-- EOC English III -->
</xs:enumeration>
<xs:enumeration value="53"/>
<xs:enumeration value="54"/>
<xs:enumeration value="55"/>
<xs:enumeration value="56"/>
<xs:enumeration value="57"/>
<xs:enumeration value="58"/>
<xs:enumeration value="59"/>
<xs:enumeration value="60"/>
<xs:enumeration value="61"/>
<xs:enumeration value="62"/>
<xs:enumeration value="63"/>
<xs:enumeration value="64"/>
<xs:enumeration value="65"/>
<xs:enumeration value="66"/>
<xs:enumeration value="67"/>
<xs:enumeration value="68"/>
<xs:enumeration value="69"/>
<xs:enumeration value="70"/>
<xs:enumeration value="71">
  <xs:annotation>
    <xs:documentation>Deprecated: Use code 'E0'</xs:documentation>
  </xs:annotation>
  <!-- EOC English I Reading -->
</xs:enumeration>
<xs:enumeration value="72">
  <xs:annotation>
    <xs:documentation>Deprecated: Use code 'E1'</xs:documentation>
  </xs:annotation>
  <!-- EOC English I Writing -->
</xs:enumeration>
<xs:enumeration value="73">
  <xs:annotation>
    <xs:documentation>Deprecated: Use code 'E2'</xs:documentation>
  </xs:annotation>
  <!-- EOC English II Reading -->
</xs:enumeration>
```

```
<xs:enumeration value="74">
  <xs:annotation>
    <xs:documentation>Deprecated: Use code 'E3'</xs:documentation>
  </xs:annotation>
  <!-- EOC English II Writing -->
</xs:enumeration>
<xs:enumeration value="75">
  <xs:annotation>
    <xs:documentation>Deprecated: Use code 'E4'</xs:documentation>
  </xs:annotation>
  <!-- EOC English III Reading -->
</xs:enumeration>
<xs:enumeration value="76">
  <xs:annotation>
    <xs:documentation>Deprecated: Use code 'E5'</xs:documentation>
  </xs:annotation>
  <!-- EOC English III Writing -->
</xs:enumeration>
<xs:enumeration value="77"/>
<xs:enumeration value="A0"/>
<xs:enumeration value="A1"/>
<xs:enumeration value="A2"/>
<xs:enumeration value="A3"/>
<xs:enumeration value="A4"/>
<xs:enumeration value="A5"/>
<xs:enumeration value="A6"/>
<xs:enumeration value="A7"/>
<xs:enumeration value="A8"/>
<xs:enumeration value="A9"/>
<xs:enumeration value="AA"/>
<xs:enumeration value="AB"/>
<xs:enumeration value="AC"/>
<xs:enumeration value="AD"/>
<xs:enumeration value="AE"/>
<xs:enumeration value="AF"/>
<xs:enumeration value="AG"/>
<xs:enumeration value="AH"/>
<xs:enumeration value="AJ"/>
<xs:enumeration value="AK"/>
<xs:enumeration value="AL"/>
<xs:enumeration value="AM"/>
<xs:enumeration value="AN"/>
<xs:enumeration value="AP"/>
<xs:enumeration value="AQ"/>
<xs:enumeration value="B0"/>
<xs:enumeration value="B1"/>
<xs:enumeration value="B2"/>
<xs:enumeration value="B3"/>
<xs:enumeration value="B4"/>
<xs:enumeration value="B5"/>
<xs:enumeration value="B6"/>
<xs:enumeration value="B7"/>
<xs:enumeration value="B8"/>
<xs:enumeration value="C0"/>
<xs:enumeration value="C1"/>
```



```

<xs:enumeration value="C2"/>
<xs:enumeration value="C3"/>
<xs:enumeration value="C4"/>
<xs:enumeration value="C5"/>
<xs:enumeration value="C6"/>
<xs:enumeration value="C7"/>
<xs:enumeration value="C8"/>
<xs:enumeration value="C9"/>
<xs:enumeration value="CA"/>
<xs:enumeration value="CB"/>
<xs:enumeration value="CC"/>
<xs:enumeration value="CD"/>
<xs:enumeration value="CE"/>
<xs:enumeration value="CF"/>
<xs:enumeration value="CG"/>
<xs:enumeration value="D0"/>
<xs:enumeration value="D1"/>
<xs:enumeration value="D2"/>
<xs:enumeration value="D3"/>
<xs:enumeration value="D4"/>
<xs:enumeration value="D5"/>
<xs:enumeration value="D6"/>
<xs:enumeration value="D7"/>
<xs:enumeration value="D8"/>
<xs:enumeration value="D9"/>
<xs:enumeration value="DA"/>
<xs:enumeration value="DB"/>
<xs:enumeration value="DC"/>
<xs:enumeration value="DD"/>
<xs:enumeration value="DE"/>
<xs:enumeration value="DF"/>
<xs:enumeration value="DG"/>
<xs:enumeration value="E0">
  <xs:annotation>
    <xs:documentation>Deprecated: Use code 'EG'</xs:documentation>
  </xs:annotation>
  <!-- English I Reading (EOC) -->
</xs:enumeration>
<xs:enumeration value="E1">
  <xs:annotation>
    <xs:documentation>Deprecated: Use code 'EG'</xs:documentation>
  </xs:annotation>
  <!-- English I Writing (EOC) -->
</xs:enumeration>
<xs:enumeration value="E2">
  <xs:annotation>
    <xs:documentation>Deprecated: Use code 'EH'</xs:documentation>
  </xs:annotation>
  <!-- English II Reading (EOC) -->
</xs:enumeration>
<xs:enumeration value="E3">
  <xs:annotation>
    <xs:documentation>Deprecated: Use code 'EH'</xs:documentation>
  </xs:annotation>
  <!-- English II Writing (EOC) -->

```

```
</xs:enumeration>  
<xs:enumeration value="E4"/>  
<xs:enumeration value="E5"/>  
<xs:enumeration value="E6"/>  
<xs:enumeration value="E7"/>  
<xs:enumeration value="E8"/>  
<xs:enumeration value="E9"/>  
<xs:enumeration value="EA"/>  
<xs:enumeration value="EB"/>  
<xs:enumeration value="EC"/>  
<xs:enumeration value="ED"/>  
<xs:enumeration value="EF"/>  
<xs:enumeration value="EG"/>  
<xs:enumeration value="EH"/>  
<xs:enumeration value="EJ"/>  
<xs:enumeration value="F0"/>  
<xs:enumeration value="F1"/>  
<xs:enumeration value="F2"/>  
<xs:enumeration value="F3"/>  
<xs:enumeration value="F4"/>  
<xs:enumeration value="F5"/>  
<xs:enumeration value="F6"/>  
<xs:enumeration value="F7"/>  
<xs:enumeration value="F8"/>  
<xs:enumeration value="G0"/>  
<xs:enumeration value="G1"/>  
<xs:enumeration value="G2"/>  
<xs:enumeration value="G3"/>  
<xs:enumeration value="G4"/>  
<xs:enumeration value="G5"/>  
<xs:enumeration value="G6"/>  
<xs:enumeration value="G7"/>  
<xs:enumeration value="G8"/>  
<xs:enumeration value="G9"/>  
<xs:enumeration value="GA"/>  
<xs:enumeration value="GB"/>  
<xs:enumeration value="GC"/>  
<xs:enumeration value="GD"/>  
<xs:enumeration value="H0"/>  
<xs:enumeration value="H1"/>  
<xs:enumeration value="H2"/>  
<xs:enumeration value="H3"/>  
<xs:enumeration value="H4"/>  
<xs:enumeration value="H5"/>  
<xs:enumeration value="H6"/>  
<xs:enumeration value="H7"/>  
<xs:enumeration value="H8"/>  
<xs:enumeration value="J0"/>  
<xs:enumeration value="J1"/>  
<xs:enumeration value="J2"/>  
<xs:enumeration value="J3"/>  
<xs:enumeration value="J4"/>  
<xs:enumeration value="JA"/>  
<xs:enumeration value="JB"/>  
<xs:enumeration value="JC"/>
```

```
<xs:enumeration value="JD"/>
<xs:enumeration value="JE"/>
<xs:enumeration value="JF"/>
<xs:enumeration value="JG"/>
<xs:enumeration value="JH"/>
<xs:enumeration value="JJ"/>
<xs:enumeration value="JK"/>
<xs:enumeration value="JL"/>
<xs:enumeration value="JM"/>
<xs:enumeration value="JN"/>
<xs:enumeration value="JP"/>
<xs:enumeration value="JQ"/>
<xs:enumeration value="JR"/>
<xs:enumeration value="JS"/>
<xs:enumeration value="K0"/>
<xs:enumeration value="K1"/>
<xs:enumeration value="K2"/>
<xs:enumeration value="K3"/>
<xs:enumeration value="K4"/>
<xs:enumeration value="KA"/>
<xs:enumeration value="KB"/>
<xs:enumeration value="KC"/>
<xs:enumeration value="KD"/>
<xs:enumeration value="KE"/>
<xs:enumeration value="KF"/>
<xs:enumeration value="KG"/>
<xs:enumeration value="KH"/>
<xs:enumeration value="KJ"/>
<xs:enumeration value="KK"/>
<xs:enumeration value="KL"/>
<xs:enumeration value="KM"/>
<xs:enumeration value="KN"/>
<xs:enumeration value="KP"/>
<xs:enumeration value="KQ"/>
<xs:enumeration value="KR"/>
<xs:enumeration value="KS"/>
<!-- Texas Primary Reading Inventory (Grades K-2) -->
<!-- El Inventario de Lectura en Espanol de Tejas (Grades K-2) -->
<!-- Texas English Language Proficiency Assessment System (TELPAS) reading
(Grades K-12) -->
<!-- Spanish-version TAKS Reading (Grades 3-5) -->
<!-- TAKS Reading (Grades 3-9) -->
<!-- TAKS Mathematics (Grades 3-10) -->
<!-- TAKS Writing (Grades 4 and 7) -->
<!-- TAKS Science (Grades 5,8, and 10) -->
<!-- TAKS English Language Arts (Grade 10) -->
<!-- TAKS Social Studies (Grades 8 and 10) -->
<!-- TAKS Exit Level Mathematics -->
<!-- TAKS Exit Level Science -->
<!-- TAKS Exit Level Language Arts -->
<!-- TAKS Exit Level Social Studies -->
<!-- State Developed Alternative assessment -->
<!-- TELPAS writing (Grades K-12) -->
<!-- TELPAS speaking (Grades K-12) -->
<!-- TELPAS listening (Grades K-12) -->
```

<pre><!-- TAKS (Accommodated) Reading (Grades 3-9) --> <!-- TAKS (Accommodated) Mathematics (Grades 3-10) --> <!-- TAKS (Accommodated) Writing (Grades 4, 7) --> <!-- TAKS (Accommodated) Science (Grades 5, 8, 10) --> <!-- TAKS (Accommodated) English Language Arts (Grade 10) --> <!-- TAKS (Accommodated) Social Studies (Grades 8, 10) --> <!-- TAKS (Accommodated) Exit Level Mathematics --> <!-- TAKS (Accommodated) Exit Level Science --> <!-- TAKS (Accommodated) Exit Level English Language Arts --> <!-- TAKS (Accommodated) Exit Level Social Studies --> <!-- TAKS-M Reading (Grades 3-9) --> <!-- TAKS-M Mathematics (Grades 3-11) --> <!-- TAKS-M Writing (Grades 4, 7) --> <!-- TAKS-M Science (Grades 5, 8, 10, 11) --> <!-- TAKS-M English Language Arts (Grades 10, 11) --> <!-- TAKS-M Social Studies (Grades 8, 10, 11) --> <!-- TAKS-Alt Reading (Grades 3-9) --> <!-- TAKS-Alt Mathematics (Grades 3-11) --> <!-- TAKS-Alt Writing (Grades 4, 7) --> <!-- TAKS-Alt Science (Grades 5, 8, 10,11) --> <!-- TAKS-Alt English Language Arts (Grades 10, 11) --> <!-- TAKS-Alt Social Studies (Grades 8, 10, 11) --> <!-- Linguistically Accommodated Testing (LAT) TAKS Reading (Grades 3-8) --> <!-- Spanish-version LAT TAKS Reading (Grades 3-5) --> <!-- Spanish-version TAKS Mathematics (Grades 3-5) --> <!-- LAT TAKS Mathematics (Grades 3-8, 10) --> <!-- Spanish-version LAT TAKS Mathematics (Grades 3-5) --> <!-- Spanish-version TAKS Writing (Grade 4) --> <!-- Spanish-version TAKS Science (Grade 5) --> <!-- LAT TAKS Science (Grades 5, 8, 10) --> <!-- Spanish-version LAT TAKS Science (Grade 5) --> <!-- LAT TAKS English Language Arts (Grade 10) --> <!-- Spanish-version TAKS (Accommodated) Reading (Grades 3-5) --> <!-- Spanish-version TAKS (Accommodated) Mathematics (Grades 3-5) --> <!-- Spanish-version TAKS (Accommodated) Writing (Grade 4) --> <!-- Spanish-version TAKS (Accommodated) Science (Grade 5) --> <!-- LAT TAKS-M Reading (Grades 3-8) --> <!-- LAT TAKS-M Mathematics (Grades 3-8, 10) --> <!-- LAT TAKS-M Science (Grades 5, 8, 10) --> <!-- LAT TAKS-M English Language Arts (Grade 10) --> <!-- TELPAS Reading (Grades K-12) --> <!-- Grade 3 English Reading --> <!-- Grade 3 English Mathematics --> <!-- Grade 3 Spanish Reading --> <!-- Grade 3 Spanish Mathematics --> <!-- Grade 4 English Reading --> <!-- Grade 4 English Mathematics --> <!-- Grade 4 English Writing --> <!-- Grade 4 Spanish Reading --> <!-- Grade 4 Spanish Mathematics --> <!-- Grade 4 Spanish Writing --> <!-- Grade 5 English Reading --> <!-- Grade 5 English Mathematics --> <!-- Grade 5 English Science --> <!-- Grade 5 Spanish Reading --></pre>

<pre><!-- Grade 5 Spanish Mathematics --> <!-- Grade 5 Spanish Science --> <!-- Grade 6 Reading --> <!-- Grade 6 Mathematics --> <!-- Grade 7 Reading --> <!-- Grade 7 Mathematics --> <!-- Grade 7 Writing --> <!-- Grade 8 Reading --> <!-- Grade 8 Mathematics --> <!-- Grade 8 Science --> <!-- Grade 8 Social Studies --> <!-- Grade 3 Mathematics (STAAR L) --> <!-- Grade 4 Mathematics (STAAR L) --> <!-- Grade 5 Mathematics (STAAR L) --> <!-- Grade 5 Science (STAAR L) --> <!-- Grade 6 Mathematics (STAAR L) --> <!-- Grade 7 Mathematics (STAAR L) --> <!-- Grade 8 Mathematics (STAAR L) --> <!-- Grade 8 Science (STAAR L) --> <!-- Grade 8 Social Studies (STAAR L) --> <!-- Grade 3 Reading (Modified) --> <!-- Grade 3 Mathematics (Modified) --> <!-- Grade 4 Reading (Modified) --> <!-- Grade 4 Mathematics (Modified) --> <!-- Grade 4 Writing (Modified) --> <!-- Grade 5 Reading (Modified) --> <!-- Grade 5 Mathematics (Modified) --> <!-- Grade 5 Science (Modified) --> <!-- Grade 6 Reading (Modified) --> <!-- Grade 6 Mathematics (Modified) --> <!-- Grade 7 Reading (Modified) --> <!-- Grade 7 Mathematics (Modified) --> <!-- Grade 7 Writing (Modified) --> <!-- Grade 8 Reading (Modified) --> <!-- Grade 8 Mathematics (Modified) --> <!-- Grade 8 Science (Modified) --> <!-- Grade 8 Social Studies (Modified) --> <!-- Grade 3 Reading (Alternate) --> <!-- Grade 3 Mathematics (Alternate) --> <!-- Grade 4 Reading (Alternate) --> <!-- Grade 4 Mathematics (Alternate) --> <!-- Grade 4 Writing (Alternate) --> <!-- Grade 5 Reading (Alternate) --> <!-- Grade 5 Mathematics (Alternate) --> <!-- Grade 5 Science (Alternate) --> <!-- Grade 6 Reading (Alternate) --> <!-- Grade 6 Mathematics (Alternate) --> <!-- Grade 7 Reading (Alternate) --> <!-- Grade 7 Mathematics (Alternate) --> <!-- Grade 7 Writing (Alternate) --> <!-- Grade 8 Reading (Alternate) --> <!-- Grade 8 Mathematics (Alternate) --> <!-- Grade 8 Science (Alternate) --> <!-- Grade 8 Social Studies (Alternate) --> <!-- English III Reading (EOC) --></pre>
--

<pre><!-- English III Writing (EOC) --> <!-- Algebra I (EOC) --> <!-- Geometry (EOC) --> <!-- Algebra II (EOC) --> <!-- Biology (EOC) --> <!-- Chemistry (EOC) --> <!-- Physics (EOC) --> <!-- U.S. History (EOC) --> <!-- World History (EOC) --> <!-- World Geography (EOC) --> <!-- English I (EOC) --> <!-- English II (EOC) --> <!-- English III (EOC) --> <!-- Algebra I (EOC, STAAR L) --> <!-- Geometry (EOC, STAAR L) --> <!-- Algebra II (EOC, STAAR L) --> <!-- Biology (EOC, STAAR L) --> <!-- Chemistry (EOC, STAAR L) --> <!-- Physics (EOC, STAAR L) --> <!-- U.S. History (EOC, STAAR L) --> <!-- World History (EOC, STAAR L) --> <!-- World Geography (EOC, STAAR L) --> <!-- English I Reading (EOC, Modified) --> <!-- English I Writing (EOC, Modified) --> <!-- English II Reading (EOC, Modified) --> <!-- English II Writing (EOC, Modified) --> <!-- English III Reading (EOC, Modified) --> <!-- English III Writing (EOC, Modified) --> <!-- Algebra I (EOC, Modified) --> <!-- Geometry (EOC, Modified) --> <!-- Biology (EOC, Modified) --> <!-- U.S. History (EOC, Modified) --> <!-- World History (EOC, Modified) --> <!-- World Geography (EOC, Modified) --> <!-- English I (EOC, Modified) --> <!-- English II (EOC, Modified) --> <!-- English I (EOC, Alternate) --> <!-- English II (EOC, Alternate) --> <!-- English III (EOC, Alternate) --> <!-- Algebra I (EOC, Alternate) --> <!-- Geometry (EOC, Alternate) --> <!-- Biology (EOC, Alternate) --> <!-- U.S. History (EOC, Alternate) --> <!-- World History (EOC, Alternate) --> <!-- World Geography (EOC, Alternate) --> <!-- English I (EOC, STAAR Alternate 2) --> <!-- English II (EOC, STAAR Alternate 2) --> <!-- Algebra I (EOC, STAAR Alternate 2) --> <!-- Biology (EOC, STAAR Alternate 2) --> <!-- U.S. History (EOC, STAAR Alternate 2) --> <!-- Grade 3 Reading (Alternate 2) --> <!-- Grade 3 Mathematics (Alternate 2) --> <!-- Grade 4 Reading (Alternate 2) --> <!-- Grade 4 Mathematics (Alternate 2) --> <!-- Grade 4 Writing (Alternate 2) --></pre>

	<pre> <!-- Grade 5 Reading (Alternate 2) --> <!-- Grade 5 Mathematics (Alternate 2) --> <!-- Grade 5 Science (Alternate 2) --> <!-- Grade 6 Reading (Alternate 2) --> <!-- Grade 6 Mathematics (Alternate 2) --> <!-- Grade 7 Reading (Alternate 2) --> <!-- Grade 7 Mathematics (Alternate 2) --> <!-- Grade 7 Writing (Alternate 2) --> <!-- Grade 8 Reading (Alternate 2) --> <!-- Grade 8 Mathematics (Alternate 2) --> <!-- Grade 8 Science (Alternate 2) --> <!-- Grade 8 Social Studies (Alternate 2) --> <!-- English I (EOC, STAAR A) --> <!-- English II (EOC, STAAR A) --> <!-- Algebra I (EOC, STAAR A) --> <!-- Biology (EOC, STAAR A) --> <!-- U.S. History (EOC, STAAR A) --> <!-- Grade 3 Reading (STAAR A) --> <!-- Grade 3 Mathematics (STAAR A) --> <!-- Grade 4 Reading (STAAR A) --> <!-- Grade 4 Mathematics (STAAR A) --> <!-- Grade 4 Writing (STAAR A) --> <!-- Grade 5 Reading (STAAR A) --> <!-- Grade 5 Mathematics (STAAR A) --> <!-- Grade 5 Science (STAAR A) --> <!-- Grade 6 Reading (STAAR A) --> <!-- Grade 6 Mathematics (STAAR A) --> <!-- Grade 7 Reading (STAAR A) --> <!-- Grade 7 Mathematics (STAAR A) --> <!-- Grade 7 Writing (STAAR A) --> <!-- Grade 8 Reading (STAAR A) --> <!-- Grade 8 Mathematics (STAAR A) --> <!-- Grade 8 Science (STAAR A) --> <!-- Grade 8 Social Studies (STAAR A) --> </xs:restriction> </xs:simpleType> </pre>
--	--

simpleType **TestScoreType**

namespace	urn:us:tx:state:tea:TReX:v1.16									
type	restriction of xs:token									
properties	base xs:token									
used by	elements AssessmentSubTestType/SubTestScore AssessmentType/TestScore									
facets	<table border="1"> <thead> <tr> <th>Kind</th> <th>Value</th> <th>Annotation</th> </tr> </thead> <tbody> <tr> <td>minLength</td> <td>1</td> <td></td> </tr> <tr> <td>maxLength</td> <td>6</td> <td></td> </tr> </tbody> </table>	Kind	Value	Annotation	minLength	1		maxLength	6	
Kind	Value	Annotation								
minLength	1									
maxLength	6									
source	<pre> <xs:simpleType name="TestScoreType"> <xs:restriction base="xs:token"> <xs:minLength value="1"/> <xs:maxLength value="6"/> </xs:restriction> </pre>									

	<code></xs:simpleType></code>
--	-------------------------------------

simpleType **TexasGrantType**

namespace	urn:us:tx:state:tea:TREx:v1.16																		
type	restriction of xs:token																		
properties	base xs:token																		
used by	element AcademicStatusType/TexasGrant																		
facets	<table border="1"> <thead> <tr> <th>Kind</th> <th>Value</th> <th>Annotation</th> </tr> </thead> <tbody> <tr> <td>enumeration</td> <td>1</td> <td></td> </tr> <tr> <td>enumeration</td> <td>2</td> <td></td> </tr> <tr> <td>enumeration</td> <td>3</td> <td></td> </tr> <tr> <td>enumeration</td> <td>4</td> <td></td> </tr> <tr> <td>enumeration</td> <td>5</td> <td></td> </tr> </tbody> </table>	Kind	Value	Annotation	enumeration	1		enumeration	2		enumeration	3		enumeration	4		enumeration	5	
Kind	Value	Annotation																	
enumeration	1																		
enumeration	2																		
enumeration	3																		
enumeration	4																		
enumeration	5																		
source	<pre> <xs:simpleType name="TexasGrantType"> <xs:restriction base="xs:token"> <xs:enumeration value="1"/> <xs:enumeration value="2"/> <xs:enumeration value="3"/> <xs:enumeration value="4"/> <xs:enumeration value="5"/> <!-- Student is on track to complete the requirements of the SBOE-approved Recommended High School Program. --> <!-- Student is on track to complete the requirements of the SBOE-approved Distinguished High School Program. --> <!-- Student is on track to complete the requirements of the SBOE-approved Minimum High School Program. --> <!-- Student is exempt from requirements to complete at least the requirements of the SBOE-approved Recommended High School Program. --> <!-- Student is on track to complete the portion of the recommended graduation program that is available to the student at a high school that certifies to the commissioner of education that not all the necessary courses for the recommended program were offered (TEC 51.803(d)(2) and 56.304(f)(1)) --> </xs:restriction> </xs:simpleType> </pre>																		

simpleType **TitleType**

namespace	urn:us:tx:state:tea:TREx:v1.16												
type	restriction of xs:token												
properties	base xs:token												
used by	element SpecialProgramsType/TitleI												
facets	<table border="1"> <thead> <tr> <th>Kind</th> <th>Value</th> <th>Annotation</th> </tr> </thead> <tbody> <tr> <td>enumeration</td> <td>0</td> <td></td> </tr> <tr> <td>enumeration</td> <td>A</td> <td></td> </tr> <tr> <td>enumeration</td> <td>6</td> <td></td> </tr> </tbody> </table>	Kind	Value	Annotation	enumeration	0		enumeration	A		enumeration	6	
Kind	Value	Annotation											
enumeration	0												
enumeration	A												
enumeration	6												

	enumeration 7 enumeration 8 enumeration 9
source	<pre> <xs:simpleType name="TitleIType"> <xs:restriction base="xs:token"> <xs:enumeration value="0"/> <xs:enumeration value="A"/> <xs:enumeration value="6"/> <xs:enumeration value="7"/> <xs:enumeration value="8"/> <xs:enumeration value="9"/> <!-- Student attends a school that is not designated by district as Title I, Part A and student doesn't receive any Title 1, Part A funded services, or student attends a Title I, Part A targeted assistance school, but doesn't presently participate in Title I, Part A funded services and has not previously participated in Title I, Part A services at the school in which the student is currently enrolled. --> <!-- The student resides in a facility for the neglected, attends a non- Title I campus, and receives Title I, Part A services through a Title I, Part A program that is run through the central administration office. --> <!-- The student attends a Title I, Part A schoolwide program school. --> <!-- The student attends a Title I, Part A targeted assistance school and participates in Title I, Part A programs and/or services. --> <!-- The student attends a Title I, Part A targeted assistance school and does not currently participate in Title I, Part A programs and/or services, but previously participated in Title I, Part A programs and/or services at this school. --> <!-- Student does not attend a school that is designated by the district as a Title I, Part A school; however, the student receives Title I, Part A services because the student is homeless. --> </xs:restriction> </xs:simpleType> </pre>

simpleType **WithdrawGradeType**

namespace	urn:us:tx:state:tea:TREx:v1.16									
type	restriction of xs:token									
properties	base xs:token									
used by	element CourseType/WithdrawGrade									
facets	<table border="1"> <thead> <tr> <th>Kind</th> <th>Value</th> <th>Annotation</th> </tr> </thead> <tbody> <tr> <td>minLength</td> <td>1</td> <td></td> </tr> <tr> <td>maxLength</td> <td>15</td> <td></td> </tr> </tbody> </table>	Kind	Value	Annotation	minLength	1		maxLength	15	
Kind	Value	Annotation								
minLength	1									
maxLength	15									
source	<pre> <xs:simpleType name="WithdrawGradeType"> <xs:restriction base="xs:token"> <xs:minLength value="1"/> <xs:maxLength value="15"/> </xs:restriction> </xs:simpleType> </pre>									

simpleType **WithdrawReasonType**

namespace	urn:us:tx:state:tea:TREx:v1.16																																																									
type	restriction of xs:token																																																									
properties	base xs:token																																																									
used by	element EnrollmentType/WithdrawReason																																																									
facets	<table border="1"> <thead> <tr> <th>Kind</th> <th>Value</th> <th>Annotation</th> </tr> </thead> <tbody> <tr><td>enumeration</td><td>01</td><td></td></tr> <tr><td>enumeration</td><td>03</td><td></td></tr> <tr><td>enumeration</td><td>16</td><td></td></tr> <tr><td>enumeration</td><td>24</td><td></td></tr> <tr><td>enumeration</td><td>60</td><td></td></tr> <tr><td>enumeration</td><td>66</td><td></td></tr> <tr><td>enumeration</td><td>78</td><td></td></tr> <tr><td>enumeration</td><td>81</td><td></td></tr> <tr><td>enumeration</td><td>82</td><td></td></tr> <tr><td>enumeration</td><td>83</td><td></td></tr> <tr><td>enumeration</td><td>85</td><td></td></tr> <tr><td>enumeration</td><td>86</td><td></td></tr> <tr><td>enumeration</td><td>87</td><td></td></tr> <tr><td>enumeration</td><td>88</td><td></td></tr> <tr><td>enumeration</td><td>89</td><td></td></tr> <tr><td>enumeration</td><td>90</td><td></td></tr> <tr><td>enumeration</td><td>98</td><td></td></tr> <tr><td>enumeration</td><td>99</td><td></td></tr> </tbody> </table>	Kind	Value	Annotation	enumeration	01		enumeration	03		enumeration	16		enumeration	24		enumeration	60		enumeration	66		enumeration	78		enumeration	81		enumeration	82		enumeration	83		enumeration	85		enumeration	86		enumeration	87		enumeration	88		enumeration	89		enumeration	90		enumeration	98		enumeration	99	
Kind	Value	Annotation																																																								
enumeration	01																																																									
enumeration	03																																																									
enumeration	16																																																									
enumeration	24																																																									
enumeration	60																																																									
enumeration	66																																																									
enumeration	78																																																									
enumeration	81																																																									
enumeration	82																																																									
enumeration	83																																																									
enumeration	85																																																									
enumeration	86																																																									
enumeration	87																																																									
enumeration	88																																																									
enumeration	89																																																									
enumeration	90																																																									
enumeration	98																																																									
enumeration	99																																																									
source	<pre> <xs:simpleType name="WithdrawReasonType"> <xs:restriction base="xs:token"> <xs:enumeration value="01"/> <xs:enumeration value="03"/> <xs:enumeration value="16"/> <xs:enumeration value="24"/> <xs:enumeration value="60"/> <xs:enumeration value="66"/> <xs:enumeration value="78"/> <xs:enumeration value="81"/> <xs:enumeration value="82"/> <xs:enumeration value="83"/> <xs:enumeration value="85"/> <xs:enumeration value="86"/> <xs:enumeration value="87"/> <xs:enumeration value="88"/> <xs:enumeration value="89"/> <xs:enumeration value="90"/> <xs:enumeration value="98"/> <xs:enumeration value="99"/> <!-- Graduated From A Campus In This District Or Charter --> <!-- Died --> <!-- Return to Home Country --> </pre>																																																									

	<pre> <!-- College, Pursue Associate's or Bachelor's Degree --> <!-- Home Schooling --> <!-- Removed-Child Protective Srvs --> <!-- Expelled For Offense Under TEC 37.007, Cannot Return --> <!-- Enrolled In TX Private School --> <!-- Enrolled In School Outside Texas --> <!-- Withdrawn By District Because Not Entitled to Enroll --> <!-- Graduated Outside Texas Before Entering A Texas Public School-Entered A Texas Public School-Left Again --> <!-- GED outside Texas --> <!-- Enrolled in University High School Diploma Program --> <!-- Court-ordered to a GED program, has not earned a GED --> <!-- Incarcerated in a state jail or federal penitentiary as an adult --> <!-- Graduated from another state under provisions of the Interstate Compact on Education Opportunity for Military Children --> <!-- Other --> <!-- Transferred to another district --> </xs:restriction> </xs:simpleType> </pre>
--	--

simpleType **YearRangeType**

namespace	urn:us:tx:state:tea:TREx:v1.16						
type	restriction of xs:token						
properties	base xs:token						
used by	elements AcademicSessionType/SchoolYear CurrentCourseworkType/SchoolYear						
facets	<table border="0"> <tr> <td>Kind</td> <td>Value</td> <td>Annotation</td> </tr> <tr> <td>pattern</td> <td>[0-9]{4}-[0-9]{4}</td> <td></td> </tr> </table>	Kind	Value	Annotation	pattern	[0-9]{4}-[0-9]{4}	
Kind	Value	Annotation					
pattern	[0-9]{4}-[0-9]{4}						
source	<pre> <xs:simpleType name="YearRangeType"> <xs:restriction base="xs:token"> <xs:pattern value="[0-9]{4}-[0-9]{4}"/> </xs:restriction> </xs:simpleType> </pre>						

simpleType **YMDType**

namespace	urn:us:tx:state:tea:TREx:v1.16						
type	restriction of xs:token						
properties	base xs:token						
used by	elements StudentDemographicType/BirthDate AcademicStatusType/CertificateDate AcademicSummaryType/ClassRankingDate DisciplineActionType/DisciplineActionDate EnrollmentType/EntryDate EnrollmentType/ExitDate ImmunizationType/ImmunizationDate EnrollmentType/WithdrawDate						
facets	<table border="0"> <tr> <td>Kind</td> <td>Value</td> <td>Annotation</td> </tr> <tr> <td>pattern</td> <td>[0-9]{4}-[01]?[0-9]-[0123]?[0-9]</td> <td></td> </tr> </table>	Kind	Value	Annotation	pattern	[0-9]{4}-[01]?[0-9]-[0123]?[0-9]	
Kind	Value	Annotation					
pattern	[0-9]{4}-[01]?[0-9]-[0123]?[0-9]						
source	<pre> <xs:simpleType name="YMDType"> <xs:restriction base="xs:token"> <xs:pattern value="[0-9]{4}-[01]?[0-9]-[0123]?[0-9]"/> </xs:restriction> </xs:simpleType> </pre>						

	<pre></xs:restriction> </xs:simpleType></pre>
--	---

simpleType **YMType**

namespace	urn:us:tx:state:tea:TREx:v1.16						
type	restriction of xs:token						
properties	base xs:token						
used by	elements AssessmentType/ExitRequirementMetDate AcademicStatusType/GraduationDate PerfAckAplbType/MetDate PerfAckCollegeAssessType/MetDate PerfAckBillingBilitType/MetDate PerfAckCertLicType/MetDate PerfAckDualCreditType/MetDate AcademicStatusType/SpeechMetDate AssessmentType/TestDate						
facets	<table border="1"> <thead> <tr> <th>Kind</th> <th>Value</th> <th>Annotation</th> </tr> </thead> <tbody> <tr> <td>pattern</td> <td>[0-9]{4}-[01]?[0-9]</td> <td></td> </tr> </tbody> </table>	Kind	Value	Annotation	pattern	[0-9]{4}-[01]?[0-9]	
Kind	Value	Annotation					
pattern	[0-9]{4}-[01]?[0-9]						
source	<pre><xs:simpleType name="YMType"> <xs:restriction base="xs:token"> <xs:pattern value="[0-9]{4}-[01]?[0-9]"/> </xs:restriction> </xs:simpleType></pre>						

XML Schema documentation generated by [XMLSpy](http://www.altova.com/xmlspy) Schema Editor <http://www.altova.com/xmlspy>